



©2023 The Editors(s)

This is an Open Access book distributed under the terms of the Creative Commons Attribution-Non Commercial-No Derivatives Licence (CC BY-NC-ND 4.0), which permits copying and redistribution in the original format for non-commercial purposes, provided the original work is properly cited. (<http://creativecommons.org/licenses/by-nc-nd/4.0/>). This does not affect the rights licensed or assigned from any third party in this book.

This title was made available Open Access through a partnership with Knowledge Unlatched.

IWA Publishing would like to thank all of the libraries for pledging to support the transition of this title to Open Access through the 2023 KU Partner Package program.



VOLUME I

Includes comprehensive assessment tools as well as practical models on "Circular Economy" with interesting real-world case studies and theoretical and numerical questions and solutions, recent scientific information, and practical exercises

MARINE PLASTICS ABATEMENT

Challenges, Implications, Assessments and Circularity

Edited by Thammarat Koottatep, Ekbordin Winijkul,
Xue Wenchao, Atitaya Panuvatvanich,
Chettiyappan Visvanathan, Tatchai Pussayanavin,
Nantamol Limphitakphong and Chongrak Polprasert



Marine Plastics Abatement

Marine Plastics Abatement

*Challenges, Implications, Assessments
and Circularity (Volume 1)*

Edited by

Thammarat Koottatep, Ekbordin Winijkul,
Wenchao Xue, Atitaya Panuvatvanich,
Chettiyappan Visvanathan,
Tatchai Pussayanavin,
Nantamol Limphitakphong and
Chongrak Polprasert



Published by

IWA Publishing
Unit 104–105, Export Building
1 Clove Crescent
London E14 2BA, UK
Telephone: +44 (0)20 7654 5500
Fax: +44 (0)20 7654 5555
Email: publications@iwap.co.uk
Web: www.iwapublishing.com

First published 2023

© 2023 IWA Publishing

Apart from any fair dealing for the purposes of research or private study, or criticism or review, as permitted under the UK Copyright, Designs and Patents Act (1998), no part of this publication may be reproduced, stored or transmitted in any form or by any means, without the prior permission in writing of the publisher, or, in the case of photographic reproduction, in accordance with the terms of licenses issued by the Copyright Licensing Agency in the UK, or in accordance with the terms of licenses issued by the appropriate reproduction rights organization outside the UK. Enquiries concerning reproduction outside the terms stated here should be sent to IWA Publishing at the address printed above.

The publisher makes no representation, express or implied, with regard to the accuracy of the information contained in this book and cannot accept any legal responsibility or liability for errors or omissions that may be made.

Disclaimer

The information provided and the opinions given in this publication are not necessarily those of IWA and should not be acted upon without independent consideration and professional advice. IWA and the Editors and Authors will not accept responsibility for any loss or damage suffered by any person acting or refraining from acting upon any material contained in this publication.

British Library Cataloguing in Publication Data

A CIP catalogue record for this book is available from the British Library

ISBN: 9781789063196 (Paperback)

ISBN: 9781789063202 (eBook)

ISBN: 9781789063219 (ePub)

Doi: 10.2166/9781789063202

This eBook was made Open Access in January 2023.

© 2023 The Editors.

This is an Open Access book distributed under the terms of the Creative Commons Attribution Licence (CC BY-NC-ND 4.0), which permits copying and redistribution for non-commercial purposes with no derivatives, provided the original work is properly cited (<https://creativecommons.org/licenses/by-nc-nd/4.0/>). This does not affect the rights licensed or assigned from any third party in this book.



Contents

Foreword	vii
Chapter 1	
<i>Introduction</i>	1
<i>Chongrak Polprasert, Thammarat Koottatep, Ekbordin Winijkul, Tatchai Pussayanavin, Kesirine Jinda and Sittikorn Kamngam</i>	
Chapter 2	
<i>Plastic litters and public health</i>	25
<i>Chongrak Polprasert, Thammarat Koottatep, Tatchai Pussayanavin, Kesirine Jinda and Sittikorn Kamngam</i>	
Chapter 3	
<i>Marine ecosystems and emerging plastic pollution</i>	85
<i>Chongrak Polprasert, Thamasak Yeemin, Makamas Sutthacheep, Tatchai Pussayanavin, Kesirine Jinda and Sittikorn Kamngam</i>	
Chapter 4	
<i>Plastic litter investigations and surveillance</i>	133
<i>Ekbordin Winijkul, Thanapat Jansakoo and Nichakul Phosirikul</i>	
Chapter 5	
<i>Circular economy for plastic waste management</i>	185
<i>Pawan Kumar Srikanth and Chettiyappan Visvanathan</i>	
Index	223

Foreword

Since 2015, the importance of marine ecosystems has been highlighted in Sustainable Development Goal (SDGs) No. 14, which emphasizes the need to ‘Conserve and sustainably use the oceans, seas and marine resources for sustainable development.’ A constant stream of alarming facts demonstrates that the sustainability of our oceans is under severe threat from acidification, ocean warming, eutrophication, fisheries collapses and, most notably, marine plastic pollution while over 3 billion people, or 42% of the global population, rely on oceans for their livelihoods. Marine plastic litter has become a serious global issue due to the fact that about 10 million metric tons of plastic waste generated on land enters the marine environment annually, contaminating major river basins and oceans. Plastics are also difficult to biodegrade and some types are non-degradable, resulting in accumulation rather than decomposition of plastics in the environment. One estimate predicts that by 2050, the weight of plastic waste in the ocean will be greater than the weight of fish. For this reason, in March 2022, the United Nations Environment Assembly adopted a resolution entitled, ‘End Plastic Pollution’ related to the marine environment, and negotiations for an internationally legally binding instrument will begin from the second half of 2022 onward.

In the last decade, several global/regional programs to develop innovative and practical solutions have been initiated by both the public and private sectors to tackle mismanaged plastic pollution. Among these initiatives, the ‘Osaka Blue Ocean Vision’ (OBOV) with the overarching aim of reducing additional pollution by marine plastic litter to zero by 2050 was shared at the G20 Osaka Summit in 2019, and the Government of Japan has launched the **MARINE Initiative** in order to realize OBOV. Japan’s MARINE Initiative aims to advance effective actions to combat marine plastic litter on a global scale focusing on (1) management of waste, (2) recovery of marine litter, (3) innovation, and (4) empowerment.

One of the crucial factors in translating the initiative into action is to empower all stakeholders who play a significant role in marine plastic abatement, whether governmental offices, private companies, non-governmental organizations,

reuse/recycling enterprises or small-scale waste pickers. The Ministry of Foreign Affairs (MOFA), Japan has thus supported the Asian Institute of Technology (AIT), Thailand in establishing and implementing an intensive empowerment program with an emphasis on marine plastic pollution. This initiative led to the very first one-year Master's in 'Marine Plastics Abatement (MPA)' program in the region, officially inaugurated in August 2020.

This unique program has recruited almost 100 young environmental leaders from more than 30 countries in Asia, Africa, and Latin America for training through comprehensive coursework and innovative research which will contribute immensely to realizing SDG14: Life Below Water and others such as SDG11: Sustainable Cities and Communities; SDG12: Responsible Consumption and Production; and SDG17: Partnerships for the Goals. The curriculum of the MPA program has drawn widely from up-to-date research findings, process innovations, technological advancement as well as social interventions/campaigns by experts and professionals from AIT and its partner institutions. To increase awareness and widen empowerment on this subject, it is essential to consolidate new areas of knowledge and expertise into a book which is accessible to other audiences from different sectors.

I am certain that readers of this book will come to understand not only the root causes and negative impacts on human and environmental health of the marine plastics issue, but also various means to reduce mismanaged plastics through innovative technology. They will also learn about the application of the circular economy and become familiar with innovative business models and lessons learnt from regional case studies around the world. I, therefore wish to acknowledge the authors and editors led by AIT and their respective partner universities, i.e., Thammasat University, Ramkhamhaeng University, Chulalongkorn University, Thailand for coordinating the edition and publication of this reference book. As the community of professionals grows, my personal expectation is for this book to be regularly updated to capture new evidence and scientific findings for new generations who might face and be affected by even more serious marine pollution.

H.E. Mr. NASHIDA Kazuya
Ambassador of Japan to Thailand

List of contributors

Adaobi Enyekwe Marine Plastics Abatement Program, School of Environment, Resources and Development, Asian Institute of Technology, Pathum Thani, Thailand.

Atitaya Panuvatvanich Marine Plastics Abatement Program, School of Environment, Resources and Development, Asian Institute of Technology, Pathum Thani, Thailand.

Chawalit Chaiwong Marine Plastics Abatement Program, School of Environment, Resources and Development, Asian Institute of Technology, Pathum Thani, Thailand.

Chettiyappan Visvanathan Marine Plastics Abatement Program, School of Environment, Resources and Development, Asian Institute of Technology, Pathum Thani, Thailand.

Chongrak Polprasert Department of Civil Engineering, Faculty of Engineering, Thammasat University, Pathum Thani, Thailand.

Ekbordin Winijkul Marine Plastics Abatement Program, School of Environment, Resources and Development, Asian Institute of Technology, Pathum Thani, Thailand.

Gayathri Govindarajan Marine Plastics Abatement Program, School of Environment, Resources and Development, Asian Institute of Technology, Pathum Thani, Thailand.

Kavinda Gunasekara Geoinformatics Center, Asian Institute of Technology, Pathum Thani, Thailand.

Kesirine Jinda Marine Plastics Abatement Program, School of Environment, Resources and Development, Asian Institute of Technology, Pathum Thani, Thailand.

Makamas Sutthacheep Marine Biodiversity Research Group, Department of Biology, Faculty of Science, Ramkhamhaeng University, Bangkok, Thailand.

Nantamol Limphitakphong Environmental Research Institute, Chulalongkorn University, Bangkok, Thailand.

Natthapong Proysurin Marine Plastics Abatement Program, School of Environment, Resources and Development, Asian Institute of Technology, Pathum Thani, Thailand.

Nichakul Phosirikul Marine Plastics Abatement Program, School of Environment, Resources and Development, Asian Institute of Technology, Pathum Thani, Thailand.

Pawan Kumar Srikanth Marine Plastics Abatement Program, School of Environment, Resources and Development, Asian Institute of Technology, Pathum Thani, Thailand.

Peerawit Janta Marine Plastics Abatement Program, School of Environment, Resources and Development, Asian Institute of Technology, Pathum Thani, Thailand.

Sitttikorn Kamngam Marine Plastics Abatement Program, School of Environment, Resources and Development, Asian Institute of Technology, Pathum Thani, Thailand.

Stephanie Ubsdell Marine Plastics Abatement Program, School of Environment, Resources and Development, Asian Institute of Technology, Pathum Thani, Thailand.

Suraj Pradhan Marine Plastics Abatement Program, School of Environment, Resources and Development, Asian Institute of Technology, Pathum Thani, Thailand.

Tatchai Pussayanavin Department of Environmental Science, Faculty of Science and Technology, Ramkhamhaeng University, Bangkok, Thailand.

Thamasak Yeemin Marine Biodiversity Research Group, Department of Biology, Faculty of Science, Ramkhamhaeng University, Bangkok, Thailand.

Thammarat Koottatep Marine Plastics Abatement Program, School of Environment, Resources and Development, Asian Institute of Technology, Pathum Thani, Thailand.

Thanapat Jansakoo Marine Plastics Abatement Program, School of Environment, Resources and Development, Asian Institute of Technology, Pathum Thani, Thailand.

Thanisa Choombala AUA Language Center, Bangkok, Thailand.

Thusita Rathnayake Marine Plastics Abatement Program, School of Environment, Resources and Development, Asian Institute of Technology, Pathum Thani, Thailand.

Wenchao Xue Marine Plastics Abatement Program, School of Environment, Resources and Development, Asian Institute of Technology, Pathum Thani, Thailand.

Chapter 1

Introduction

*Chongrak Polprasert, Thammarat Koottatep, Ekborderin Winijkul,
Tatchai Pussayanavin, Kesirine Jinda and Sitttikorn Kamngam*

Table of Contents

1.1	Introduction	1
1.2	Plastic Production and Trends	2
1.2.1	Synthesis uses and properties of plastics	2
1.2.2	Production of plastic products	3
1.2.3	Advantages of plastic products	3
1.3	Plastic Processing Technology and its Additives	4
1.3.1	Production process of plastics	4
1.3.2	Types of plastics	4
1.3.3	Use of plastic products	8
1.4	Mismanaged Plastic Litter in Waste Management Practices	14
1.4.1	Disposed of plastic waste in municipal solid waste	14
1.4.2	Present pollution trends	16
1.4.3	Degradation of plastics in the environment	18
	References	20

1.1 INTRODUCTION

Owing to their properties, plastics are one of the most-used polymers worldwide. As a consequence of its widespread usage from home to industrial levels, billions of tons of plastic debris accumulate in environmental systems, including water, air, and soil. As the degradation processes of plastics are prolonged and take a long time for them to degrade in the natural environment, plastic wastes pose a serious threat to both terrestrial and marine biota.

According to a recent marine environment study, several marine species have died as a result of plastic trash ingestion or entanglement in plastic debris. Nevertheless, among the various methods to tackle plastic waste, plastic reduction at the source and the improvement of plastic waste management

techniques such as plastic recycling and recovery, including bioremediation among others are considered eco-friendly alternatives and cost-effective methods (Ru *et al.*, 2020).

This chapter introduces a comprehensive and up-to-date review of the issues and solution ideas on *plastic productions and trends, plastic processing technology and its additives, mismanaged plastic litters in waste management practices, macro-, micro- and nano plastics, bioaccumulation and biomagnification of plastic litter, toxicology and toxicity of micro-contaminants in plastics, implications on public and human health, and impacts of microplastics on human health.*

1.2 PLASTIC PRODUCTION AND TRENDS

1.2.1 Synthesis uses and properties of plastics

The diversity and various qualities of polymer, the main component in plastics, render plastics tremendously useful materials in a wide range of products that enable medical and technological advancements, and common societal facilities (Gilbert, 2017). Some examples of the diverse plastic properties are light weight, high strength, high durability, high corrosion resistance, high thermal and electrical insulation properties (EPA, 2021). Moreover, the considerable potential for new plastic applications has brought benefits to mankind in various forms including novel medical applications, the generation of renewable energy, and energy consumption reduction in transportation (Hammer *et al.*, 2012; Thompson *et al.*, 2009).

Currently, almost all aspects of daily life involve plastics, for instance, in infrastructure, transport, telecommunications, clothing, footwear, and packaging materials that facilitate the transport of a wide range of food, drinks, and other goods (Plastics Europe, 2018). The term plastics, as commonly used, refers to a group of synthetic *polymers (defined as large organic molecules composed of repeating carbon-based units or chains that occur naturally and can be synthesized)*. The polymers that make up plastics are long molecular chains made from joined short repeating sub-units in a chemical process known as polymerization. On the contrary, monomers are molecules capable of combining, by a process called polymerization, to form a polymer (Edmondson & Gilbert, 2017; SAPEA, 2019). For example, monomer ethylene is polymerized, using a catalyst to form polyethylene (PE) (Kershaw, 2016).

The production of numerous monomers used to synthesize plastics, such as ethylene and propylene are derived from fossil hydrocarbons, while polymers can also be natural or synthetic (Gilbert, 2017). Common natural polymers include chiton (insect and crustacean exoskeleton), lignin and cellulose (cell walls of plants), polyester (cutin), and protein fiber (wool, silk), including protein fiber and starch. These are also generated from agricultural or specifically grown crops such as sugarcane, corn, and trees (Bowers *et al.*, 2014; Brodin *et al.*, 2017; UNEP, 2018a, 2018b).

Plastics have been found in all major basins and oceans, with an estimated 4–12 million metric tons of plastic waste generated on land entering the marine environment in 2010 alone. On the contrary, almost all the generally used

plastics are difficult to biodegrade, or some types are non-degradable, resulting in accumulation rather than decomposition of plastics in the natural environment (water, air, and soil, including landfills) (Horton *et al.*, 2017). Contamination of freshwater systems and terrestrial habitats is also increasingly reported, as is environmental contamination with synthetic fibers (Jambeck *et al.*, 2015). Furthermore, plastic debris easily gets transported into aquatic and terrestrial domains through the atmosphere. Recently, disposable face masks (produced from polymers) contaminated with the Coronavirus have also added to the environmental pollution as these are likely sources of plastic debris.

1.2.2 Production of plastic products

Among consumption patterns of widely used types of plastics in different applications, well over a third of consumption is in packaging applications such as containers and plastic bags (Hammer *et al.*, 2012), and building products including common products such as plastic pipes and vinyl cladding (Gilbert, 2017; Plastics Europe, 2018).

Plastics are a mixture of macromolecules and chemicals, ranging from several nanometers to meters. The commercial production of plastics started around 1950s and has seen an exceptional growth to the present global annual production of 330 million metric tons in 2016 including the resin used in spinning textile fibers (Plastics Europe, 2018). Plastic use has increased, especially in developing countries (Geyer *et al.*, 2017; Kershaw, 2016; Kole *et al.*, 2017). The global production of plastics has been following a clear exponential rising trend since the beginning of mass plastic consumption and production in the 1950s, and from a global production of 311 million tons in 2014; it is projected that plastic production to reach approximately 1800 million tons in 2050 (UNEP, 2018a, 2018b).

1.2.3 Advantages of plastic products

Almost all aspects of daily life involve plastics such as clothing, footwear, and products used in food and public health industries. Over 40 million tons of plastics are processed as textile fibers such as nylon, polyester, and acrylics, which are used in the clothing industry. Moreover, polycotton clothing contains high polyethylene terephthalate (PET) plastics; high-performance clothing is almost exclusively made from plastic-polyesters, fluoropolymers, and nylons (Gilbert, 2017). Furthermore, fleece clothing is 100% plastic and can be made from recycled PET. Most footwear also relies heavily on plastics; the footbeds and outsoles are made from polyurethane or other elastomeric material, while the uppers might be vinyl or other synthetic polymers (Geyer *et al.*, 2017; Shah *et al.*, 2008).

Plastics in various types such as PE, polystyrene (PS), polyurethane, polyvinyl chloride (PVC), polypropylene (PP), PET, nylon, polycarbonate, and polytetrafluoroethylene are used in daily life. Plastic polymers show the highest usage in different parts of the world. Various plastic-based products such as plastic wares, plastic packaging material (for food and beverages), plastic bottles, and other miscellaneous articles have widely dominated the various markets (Arutchelvi *et al.*, 2008; Sangale *et al.*, 2012; Varda *et al.*, 2014). The overview

of plastic usage at the global level are: 35% of packaging, 23% of building and construction, 8% of electric and electronics, 8% of furniture/ housewares, 8% of transport, 7% of agriculture, 3% of sports, 2% of mechanical engineering, 2% of medical, toys, and 1% of footwear (Varda *et al.*, 2014).

Due to their light weight, plastics reduce transportation costs, thus reducing atmospheric carbon dioxide emissions. Plastics can also improve performance and reduce the costs of building materials. In addition, plastic material benefits may facilitate clean drinking water supplies and enable medical devices ranging from surgical equipment to advanced packaging materials (Geyer *et al.*, 2017).

1.3 PLASTIC PROCESSING TECHNOLOGY AND ITS ADDITIVES

1.3.1 Production process of plastics

Plastics are a wide range of synthetic or semi-synthetic organic compounds that are malleable and so can be molded into solid objects (Hammer *et al.*, 2012; Niaounakis, 2017; UNEP, 2016). Plastics are organic materials, just like wood, paper, or wool. Numerous organic, synthetic or processed materials are mostly thermoplastics or thermosetting polymers of high molecular weight that can be made into objects, films, or filaments (US EPA, 2016). As the petrochemical industry is the greatest contributing factor in the growth of the plastic industry, the plastic industry is integrated with the oil industry. Currently, the two industries have a remarkable degree of interdependence. Thus, if the current production and use trends continue unabated, then plastic production is estimated to increase, approaching 2000 million tons by 2050 (as described in Section 1.2).

1.3.2 Types of plastics

With respect to characteristics, plastics are lightweight, tough, and resistant to chemical materials that can be molded in various ways and utilized in a wide range of applications. Although it is also difficult to corrode and biodegrade, photodegradation can slowly break down plastics into tiny fragments known as microplastics (Niaounakis, 2017; UNEP, 2018a, 2018b). Polymers can be natural or synthetic. Natural polymers include materials such as cellulose, protein fiber, and starch. The polymers that make up plastics are long molecular chains made from joined short repeating subunits in a chemical process known as polymerization (see Section 1.1). Raw materials for plastics are mostly obtained from non-renewable resources, including products from the fossil fuel industry such as styrene and ethylene (Andrady & Neal, 2009; Gilbert, 2017). Plastic manufacturing requires an estimated 4–8% of global oil production, for raw materials and energy for processing (World Economic Forum, 2016; Zhu *et al.*, 2016).

Bio-based polymers which are becoming increasingly popular (Hansen *et al.*, 2014; Zhu *et al.*, 2016) are generated from agricultural or forestry waste or specifically grown crops such as sugarcane, corn, and trees (Bowers *et al.*, 2014; Brodin *et al.*, 2017; Zhu *et al.*, 2016). Bioplastics usually refer to plastics sourced from renewable resources, but, sometimes, they are used to refer to biodegradable plastics (Kershaw, 2016). Nevertheless, during the production of both conventional plastics and bioplastics, various additives may be added to the polymer to change its character (Edmondson & Gilbert, 2017; Kershaw &

Rochman, 2015). Generally, additives allow plastics to take on many forms with varying appearances, durability, and performance. Common additives include plasticizers (used to enhance flexibility and durability), ultraviolet blockers, thermal stabilizers, dyes and pigments, flame retardants among others (Hansen *et al.*, 2014). However, some of the chemicals are harmful in low quantities and can leach out of plastics, posing health and environmental risks (de Souza Machado *et al.*, 2018; Oehlmann *et al.*, 2009; Talsness *et al.*, 2009; Thompson *et al.*, 2009).

For plastics derived from organic products, the raw materials used to produce these plastics are natural products such as cellulose, coal, natural gas, salt, and crude oil. Due to a complex mixture of compounds in crude oil, plastic production starts with a distillation process in an oil refinery involving the separation of heavy crude oil into lighter groups called fractions (Gilbert, 2017; Zhu *et al.*, 2016). Each fraction is a mixture of hydrocarbon chains (chemical compounds made up of carbon and hydrogen), which differ in terms of size and structure of the molecules (Boucher & Friot, 2017; Niaounakis, 2017). During plastic production, several factors of polymer such as the solubility characteristics, the effect of specific chemicals and environments on polymer at elevated temperatures, the effect of high-energy irradiation, the aging and weathering should be considered. Moreover, plastic polymers are mixed with various additives to improve performance, such as carbon and silica to reinforce the material, plasticizers to render the material pliable, thermal, and ultraviolet (UV) stabilizers, flame retardants, and coloring. Some additive chemicals are potentially toxic, and there is a particular concern about the extent to which additives released in the environment from plastic products of high production volume and wide usage (e.g. phthalates, bisphenol A (BPA), bromine flame retardants, UV screens, and anti-microbial agents) have adverse effects on animal or human populations (Thompson *et al.*, 2009), while a recent study estimated that the direct ingestion of microplastics by some aquatic species is a negligible pathway for exposure to nonylphenol and BPA (Koelmans *et al.*, 2014).



1.3.2.1 Petroleum-based plastics

In engineering, soil mechanics, materials science and geology, plasticity refers to the property of a material able to deform without fracturing. According to the US EPA (2016), plastic material can be categorized into two types based on the properties: (a) *Thermoplastics* which are polymers that soften when heated and solidify upon cooling, allowing them to be remolded and recycled without negatively affecting the material physical properties (common examples include PE, PP, PS, and PVC); and (b) *Thermosets* which are plastics that are set into a mold once and cannot be re-softened or molded again. Due to their properties, thermosets are appropriate for high-heat applications such as electronics and appliances such as phenolic resins, amino resins, polyester resins, and polyurethanes.

1.3.2.1.1 Thermoplastics

The most commonly used plastics around the globe accounting for 69% of the global plastics used are PE, PP, PVC, PET, and PS (Emily Petsko, 2020). The symbols and properties of these plastics are illustrated in Table 1.1.

Table 1.1 Symbol types and properties of plastics.

Symbol	Properties of Plastics
 PETE	Clear, strong, and lightweight with high ductility and impact strength as well as low friction
 HDPE	Stiff and hardwearing; hard to the breakdown in sunlight
 LDPE	Lightweight, low-cost, versatile; fails under mechanical and thermal stress
 V	Can be rigid or soft via plasticizers; used in construction, healthcare, electronics
 PP	Tough and resistant with effective barrier against water and chemicals
 PS	Lightweight, structurally weak and easily dispersed
 OTHER	Diverse in nature with various properties

- (1) PE is a thermoplastic and elastic polymer which is popularly used in plastic containers, bottles, bags, and plastic toys. In addition, it can be used to produce plastic cement. The types of PE, depending on its density and branching, are low-density polyethylene (LDPE) and linear LDPE, linear versions or high-density polyethylene (HDPE) and ultra-high molecular weight PE and cross-linked PE.
- (2) PP is a thermoplastic polymer used in food containers, packaging, toys, furniture, and textiles. It is characterized by its high durability, transparency, and resistance to chemical stress, and it can sometimes contain dyes, antioxidants and, in some cases, flame retardants.
- (3) PVC is one of the most used thermoplastic polymers in the world. It is used in construction, packaging for food, textiles, and medical materials.

Other specific applications include cosmetic containers, electrical conduits, plumbing pipes and fittings, blister packs, wall cladding, roof sheeting, bottles, garden hoses, shoe soles, cable sheathing, blood bags, tubing, watch straps, and commercial cling wraps.

- (4) PET is a clear, strong, and lightweight plastic, commonly found in beverage bottles, perishable food containers, mouthwash, jars, and plastic bottles. Being impact resistant, PET is used in textiles and packaging, and its materials may contain dyes and color pigments.
- (5) PS is used for lining refrigerators, packaging, construction, and trays in the medical industry.

1.3.2.2 *Bio-based plastics*

Bioplastics refer to either bio-based or biodegradable sources which are made from renewable resources instead of fossil fuels (European Bioplastics, 2020; Napper *et al.*, 2015; UNEP, 2015). Generally, renewable carbon resources include corn, potatoes, rice, soy, sugarcane, wheat, and vegetable oil. Sugar cane is also processed to produce ethylene, which can then be used to manufacture PE among others, while starch can be processed to produce lactic acid and subsequently polylactic acid (PLA).

Biodegradable plastics are plastics that can be decomposed by living organisms, usually microbes. Biodegradable plastics are commonly produced with renewable raw materials, micro-organisms, petrochemicals, or combinations of all three.

Non-biodegradable plastics are generally comprised of carbon, hydrogen and oxygen. Because the source of carbon is entirely and partly from petrochemicals, these plastics are referred to as non-biodegradable. Non-biodegradable describes polymers that do not break down into a natural, environmentally safe condition over time through biological processes (Rahman & Syamsu, 2018).

Most plastics are non-biodegradable, which are widely used due to their low cost, versatility, and durability. The durability is due in part to the fact that plastics are an uncommon target for microorganisms, making it non-biodegradable. Furthermore, the durability is partly due to the inability of microbes to digest plastics, rendering them non-biodegradable. On the contrary, most plastics can be made biodegradable by adding chemicals that break down the structure of polymer. Bioplastics and bio-based plastics are plastics made from renewable biological resources. Bioplastics encompass many materials that are either bio-sourced or biodegradable or both. A biodegradable material can be decomposed under the actions of microorganisms (bacteria, fungi, algae, earthworms) with end products such as water, carbon dioxide, and methane. Oxo-degradable or oxo-biodegradable plastics are conventional plastics such as PE with an additive that helps break down fragments. Bio-based, and biodegradable plastics can be divided into three categories: (1) biodegradable (bio-based plastics): polylactic acid, polyhydroxyalkanoates, bio polymers-polybutylene succinate; (2) biodegradable (petroleum-based plastics): polybutylene adipate terephthalate, polybutylene succinate, polycaprolactone, polyvinyl alcohol; and (3) non-biodegradable (bio-based plastics): bio-PET, bio-PE, polyethylene furanoate (PEF), bio-PP, bio-PAs, polytrimethylene terephthalate.

1.3.3 Use of plastic products

1.3.3.1 *Global plastic market*

According to European Bioplastics, the global market for plastics is forecasted to be USD 115.10 billion by 2023 from USD 80.7 billion in 2018, at a compound annual growth rate of 7.2% during the forecast period ([European Bioplastics, Nova-Institute, 2018](#)). The latest market data show that the global bioplastics production capacity is set to increase from around 2.11 million tons in 2019 to approximately 2.43 million tons in 2024. An innovative biopolymer, such as bio-based PP and polyhydroxy-alkenoates shows the highest relative growth rates. In 2019, due to the widespread application of PP in a wide range of sectors, bio-based PP entered the market on a commercial scale with a strong growth potential. Polyhydroxyalkanoates are an important polymer in which production capacities are estimated to more than triple in the next five years. These polyesters are 100% bio-based and biodegradable and feature various physical and mechanical properties depending on their chemical composition. Bio-based, non-biodegradable plastics altogether, including the drop-in solutions bio-based PE and bio-based PET, as well as bio-based PA, currently accounts for over 44% (almost 1 million tons) of the global bioplastics production capacities. For instance, increasing trend for lightweight vehicles, increasing demand for connected vehicles, and growing awareness about reducing vehicular emissions are driving the engineering plastics market in the automotive and transportation end-use industry.

1.3.3.2 *Bioplastics major end-use market*

Rigid bioplastic applications are available for cosmetics packaging of creams and lipsticks as well as beverage bottles and many more. Materials such as PLA, bio-PE, or bio-PET are used in aforementioned businesses. Some use bio-PE as materials for different packaging kinds of cosmetic products. Polylactic acid is also gaining pace in the rigid packaging market as a potentially mechanically recyclable material. Biodegradability is a feature often used for food packaging for perishables.

Bioplastics can be found in the following market segments: packaging, food service, agriculture/horticulture, consumer electronics, automotive, consumer goods, and household appliances. In 2019, global production capacities of bioplastics amounted to about 2.11 million tons with almost 53% (1.14 million tons) of the volume destined for the packaging market – the biggest market segment within the bioplastics industry ([European Bioplastics, Nova-Institute, 2018](#)). There is a high demand for packaging made from bioplastics used as food wrapping such as films and trays are particularly suitable for fresh produce such as fruit and vegetables, enabling longer shelf life.

1.3.3.3 *Plastic consumption*

1.3.3.3.1 Plastic consumption by country

Based on the amount of plastic consumption, China is among the largest consumer of plastic products, accounting for 20% of global plastic consumption, while Western Europe accounts for 18%. However, based on plastic consumption per capita, China is ranked much lower than other countries. Israel is one of

the largest per capita consumers of plastics; however, it has significantly lower plastic production rates compared to other countries. The developing countries have become the world's production hub of plastic products that are consumed overseas. For instance, India saw a steady increase in PET production in 2015–2016 (1458 kilotons of PET) compared to the previous year (982 kilotons). PET plastic production (650 kilotons) was exported in 2015–2016 from India to Bangladesh, USA, Italy, Israel, Romania, Ukraine and UAE among others. Export volumes have grown in recent years, closely tracking overall production levels in India. PET is imported to India (107 kilotons) to a smaller extent, mainly from Taiwan, China, Iran, and Malaysia.

1.3.3.3.2 Agricultural applications of plastics

The global usage of plastics in agriculture is 6.5 million tons per year. The use of plastic materials in agriculture started with the use of cellophane to cover small greenhouses, which was then replaced by PVC. Moreover, there is widespread and continuously increasing usage of plastic films in agriculture, particularly in protected horticulture. Increased yields, earlier harvests, reduced herbicide and pesticide use, frost protection, and water conservation as well as preserving, transporting, packaging, and commercializing agro-food products are some of the reported benefits of using plastics in agricultural fields. Greenhouses, tunnels, mulching, plastic reservoirs and irrigation systems, silage, crates for crop collecting, handling and transport, components for irrigation systems like fittings and spray cones, and tapes that help hold the aerial parts of the plants in the greenhouses among others are the most important applications identified by Plastics Europe in agriculture. A comprehensive overview of applications of plastics in agriculture is indicated in [Table 1.2](#).

The use of plastics in agriculture is evident in the form of the lining of farm ponds, greenhouse cultivation, micro-irrigation (drips and sprinklers), and plastic mulching. The problems resulting from plastic use are decreased soil porosity and air circulation, changed microbial communities, and lower farmland fertility. Plastic mulch should be of concern as it is a potential source of entry into the food chain system.

Table 1.2 Comprehensive overview of applications of plastics in agriculture.

Applications of Plastics in Agriculture

Protected cultivation films	Greenhouses and tunnels, low tunnels, mulching, nursery films, direct coverings, covering vineyards and orchards
Nets	Anti-hail, anti-bird, wind-breaking, shading, nets for olives and nut picking
Piping, irrigation; drainage	Water reservoirs, channel linings, irrigation tapes and pipes, drainage pipes, micro-irrigation, drippers
Packaging	Fertilizer sacks, agrochemical cans, containers, tanks for liquid storage, crates
Other	Silage films, fumigation films, bale twines, bale wraps, nursery pots, strings, and ropes

1.3.3.3.3 Industrial applications of plastics

The changing lifestyle and increasing penetration of organized retail is principally expanding the plastic product application scope. Because plastics are transparent, tough, flexible, and rigid, lightweight, and versatile forms of packaging, various industries such as food and beverage, personal care need plastic packages. The primary functions of packaging are to offer protection to the products and to ensure efficient transportation over long distances and storage. The growing use of rigid HDPE and polycarbonate plastic canisters, bottles and tanks for industrial packaging applications, as opposed to wraps, films and bags, is likely to promote better market growth for rigid plastics as compared to flexible plastics. Because of its increasing use in industrial applications, the rigid sector is forecast to rise steadily.

The global production of petroleum plastics (fossil fuel-based plastics) saw a dramatic increase, from 2 million tons in 1950 to more than 454 million tons in 2018. Between 1950 and 1980, 9.7 billion tons of plastics were produced, 50% of which was after 2005. Projections based on present growth rates indicate that plastics production should double by 2025 and more than triple by 2050. Among all types of plastics introduced in the market since 1950, PP and LDPE account for 17 and 16%, respectively, of the global plastic production followed by HDPE (13%) and poly-phthalimide (13%). Additives used in plastic products manufacturing also have a significant share in global plastic production (6%).

1.3.3.4 Plastic waste generation

1.3.3.4.1 Sources and types of plastic waste

In general, plastic waste generation rates are influenced by economic development, the degree of industrialization and public habits. These parameters are used to estimate plastic waste generation in different countries worldwide. The generation of plastic waste can be classified into pre-consumer or industrial plastics waste, and post-consumer plastics waste. In terms of pre-consumer plastic waste, the amount of waste comes from production of plastic resins and plastic products. Plastic resin is generated in synthetic resin, by-product, and residual resin production processes when sieving. Moreover, these kinds of plastic resin products could be directly recycled in the plastic factories. Some edge, gate, and defective products are inevitably generated in the plastic production and re-processing process. These types of plastic products could be directly disposed of in plastic factories. Meanwhile, the post-consumer waste comes in the form of municipal solid waste, which comes from the post-consumer market, such as industrial and agricultural plastic waste, commercial plastic waste, and residential plastic waste, as well as in the following economic sectors: distribution and large industry, agriculture, construction, and demolition, automotive, electronics, and electric. Plastic packaging has the largest share (35.8%) in the market. It is also the biggest plastic waste generator accounting for 46% of plastic waste generation, as illustrated in [Figures 1.1](#) and [1.2](#) ([Geyer et al., 2017](#)).

1.3.3.4.2 Plastic waste management

Of the 8.3 billion tons of plastics that have been introduced in the market between 1950 and 2015, a total of 5.8 billion tons of plastic waste have been

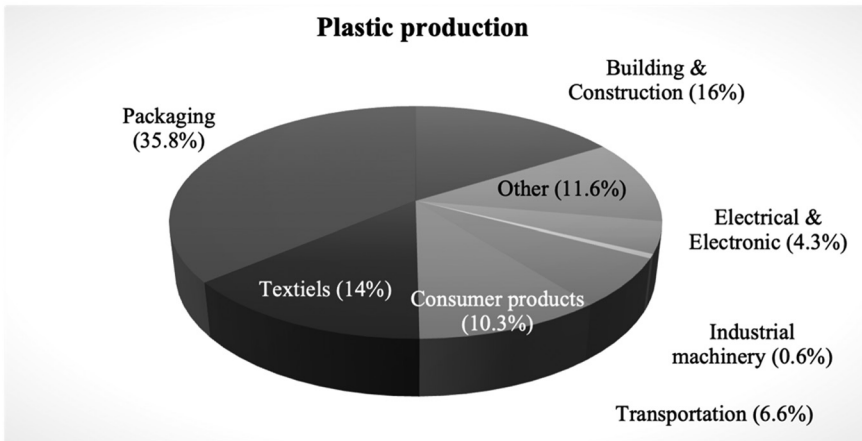

Figure 1.1 Plastic production (percentages) (454 300 000 tons) (Source: adapted from Geyer *et al.*, 2017).

generated. Of that, 12% has been incinerated, 9% recycled, and around 60% discharged in landfills or the environment. Plastic waste is disposed of in landfills and dumpsites in large amounts (56%) or escapes into the environment as shown in [Figure 1.3](#). According to a UNEP (2020) report, plastic waste recycling and incineration have increased over the years, reaching 19% and 25, respectively.

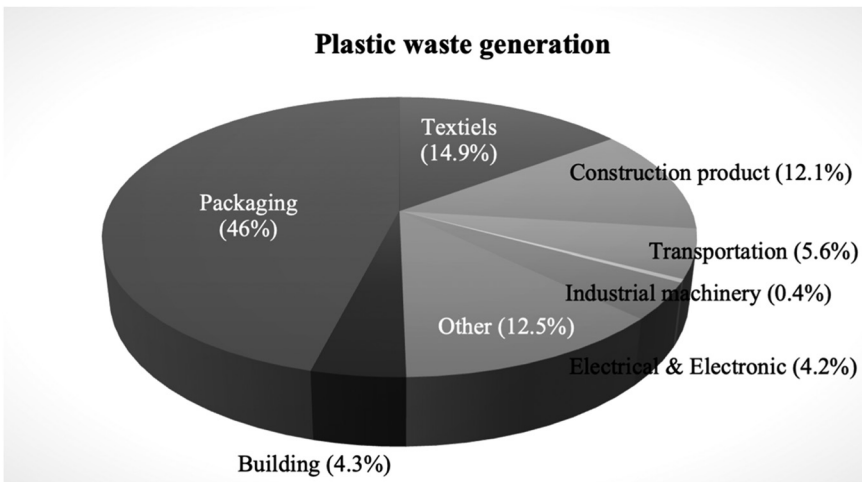

Figure 1.2 Plastic waste generation (percentages) (342 600 000 tons) (Source: adapted from Geyer *et al.*, 2017).

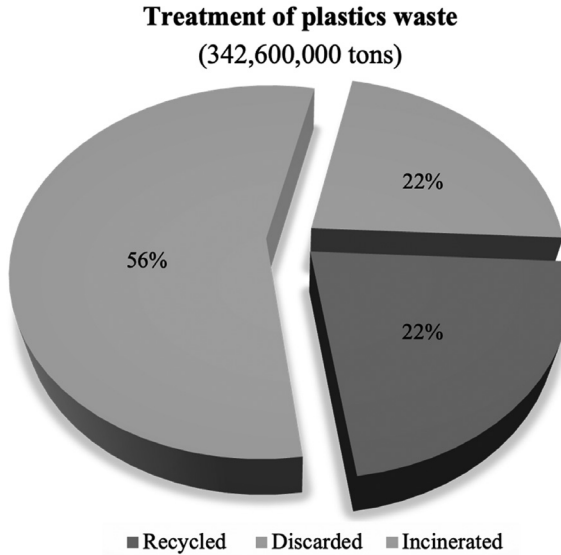

Figure 1.3 Treatment of plastic waste (percentages) (Source: adapted from [Geyer et al., 2017](#)).

1.3.3.5 Single-use plastic and its distribution production by region

Single-use plastics, referred to as disposable plastics, are designed to be discarded after a single use. They are commonly used as plastic packaging and are intended to be used only once before being discarded or recycled. Some examples are plastic bags, straws, coffee stirrers, water bottles and most food packaging (UNEP, 2018a, 2018b). Plastic packaging is mostly single-use, especially in business-to-consumer applications, and most of it is discarded the same year it is produced (shown in [Figure 1.4](#)). Global consumption of plastics can be estimated by observing the amount of plastic waste produced.

Plastic products have long life spans (or product lifetimes): building and construction materials (35 years), industrial machinery (20 years), plastic products in the transportation sector (13 years), electrical/electronic plastic products (8 years), and textiles (5 years). However, the majority have a short life cycle lasting between one day (e.g., disposable plastic cups, plates, takeaway containers or plastics bags) to three years (e.g., food and drink containers, cosmetics, or agricultural film). Currently, a global analysis of all mass-produced plastic is conducted by developing and inputting, into a comprehensive material flow model, global data on the production, use, and end-of-life fate of polymer resins, synthetic fibers, and additives (UNEP, 2020). Estimated decomposition times for plastics and other common marine debris items are shown in [Figure 1.5](#).

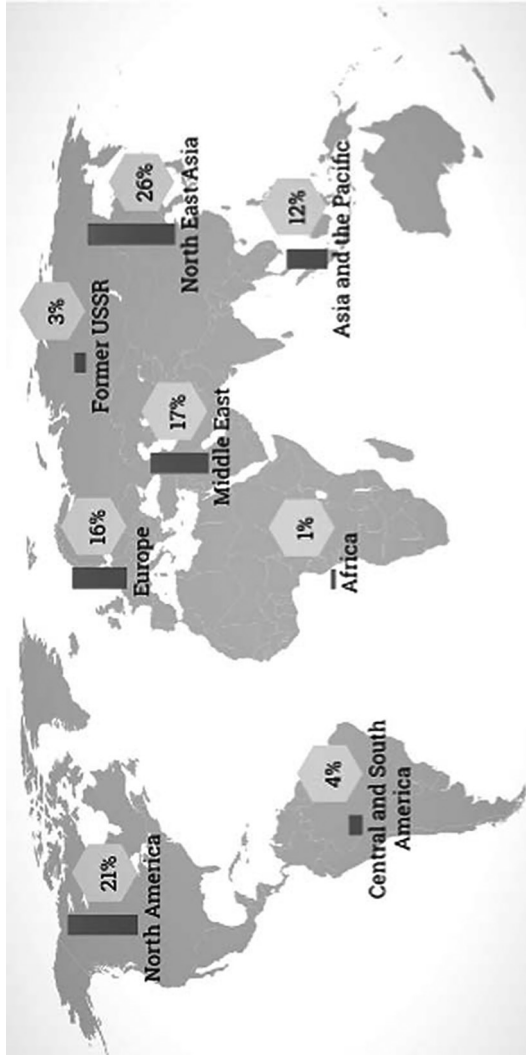

Figure 1.4 Distribution of single-use plastics production by region (UNEP, 2018a, 2018b).

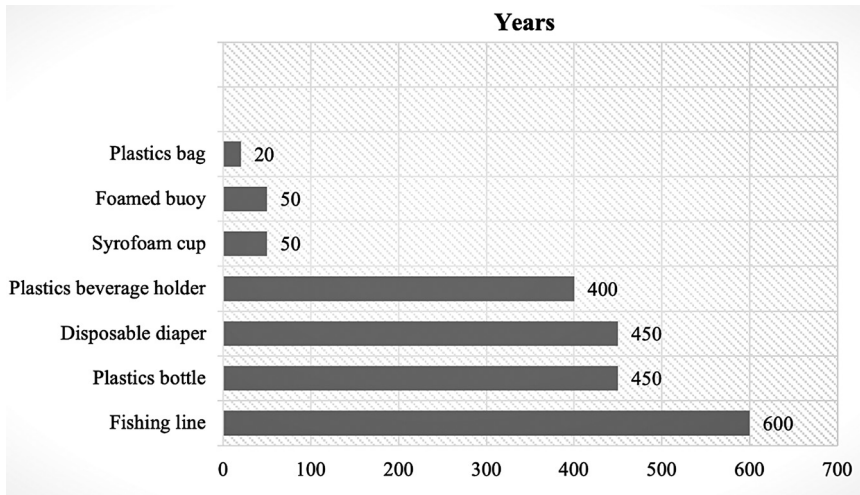

Figure 1.5 Average decomposition times of typical marine debris items (Source: adapted from [UNEP, 2020](#)).

1.4 MISMANAGED PLASTIC LITTER IN WASTE MANAGEMENT PRACTICES

1.4.1 Disposed of plastic waste in municipal solid waste

Plastic waste in municipal solid waste is distributed between three categories: plastics in use, post-consumer managed plastic waste, and mismanaged plastic waste, the last of which includes urban litter. Managed waste is accounted for and is typically disposed of by incineration or landfilling. Packaging-related plastics have a particularly short in-use phase and become, subsequently, mismanaged waste. Mismanaged waste also includes inadequately contained waste such as in open dumps and is therefore transportable via runoff and wind. Street sweepers and concerned citizen groups may have collected some mismanaged waste. Both per capita use of plastics and the population density at a given location determine consumers' local plastics demand, representing the in-use category. The former generally scales with the local gross domestic product, with the more affluent countries using as much as over 100 kg per population per year. However, in populous countries such as India or China, a relatively low per capita use of plastics coupled with a high population density can still yield a large amount of plastic waste ([Lebreton & Andrady, 2019](#)).

Plastic waste in developed countries can go through a well-established material recycling process, resulting in recycled plastic materials with some added value and energy recovery at the transfer station and final disposal site. Nevertheless, this behavior is not commonly adopted in several developing countries. [Figure 1.6](#) indicates municipal plastic waste has a considerable share in the composition of municipal solid waste in both developed and developing countries.

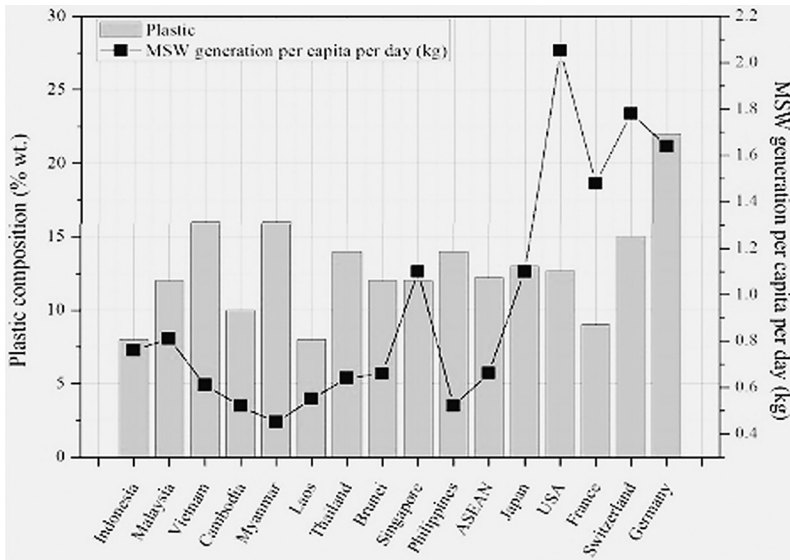

Figure 1.6 Plastic waste in MSW (per capita per day) (Source: Areeprasert *et al.*, 2017).

Mismanaged waste is the sum of either littered or inadequately disposed of waste, including disposal in dumps or open, uncontrolled landfills. The figure of mismanaged plastics is therefore linked to the effectiveness of waste management worldwide. [Jambeck *et al.* \(2015\)](#) estimated that the total mismanaged plastic waste from the coastal population accounted for 31.9 million tons in 2010. Later [Lebreton *et al.* \(2019\)](#) estimated that for the 2015 calendar year, between 60 and 99 million metric tons out of 181 million tons of global municipal plastic waste were improperly disposed of and released into the environment. Countries in Southeast Asia and the Pacific have the highest share of plastic waste deemed inadequately mismanaged and led to the escape of plastics in the terrestrial and marine environment. In Asia and sub-Saharan Africa, between 80 and 90% of plastic waste is inadequately disposed of, with China, Indonesia, the Philippines, Thailand, and Vietnam producing half of all plastic waste in the world's oceans. On the contrary, high-income countries such as European countries, North America, Australia, and Japan have effective waste management systems, and almost no plastics waste is considered inadequately managed. Scientists estimate that 8.3 billion tons of plastic had been produced globally by 2015, over a ton of plastics for every person on the planet. Of this, 6.3 billion tons (76%) had been discarded as waste. Between 1950 and 2015, 9% of plastic waste was recycled, 12% was incinerated, and the remaining 79% has accumulated in landfills and the environment. The total amount of waste generated per person varies significantly between countries in [Table 1.3](#).

Table 1.3 Total solid municipal waste and plastic waste estimates.

Countries	Waste Generation Rate (g: Person: Day)	Plastics in Waste Stream (%)	Plastic Waste Per Capita (g: Person: Day)
Denmark	1160	2.25	26
Canada	2160	1.6	35
Japan	1940	3	58
Spain	950	11	104
Australia	1190	9	107
France	1540	7.6	117
New Zealand	1370	9	124
Ireland	1990	8	159
Germany	1610	12.4	199
United Kingdom	1720	13	224
United States	1330	20	266

Source: [Lebreton et al. \(2019\)](#)

1.4.2 Present pollution trends

Over the past decade, efforts have been made to define and quantify different sources of plastic leakage, either at the country level or globally, into the terrestrial environment and waterways in [Table 1.4](#). Plastics which may escape and are found in the environment are defined as macroplastics or microplastics. Macroplastics are large plastic waste that usually enters the marine environment in their manufactured sizes, while small plastic particulates below 5 mm in size are called microplastic. Microplastics may be plastics that directly escape into the environment through small particles (e.g., microplastics in cosmetics, textiles, etc.) or maybe the result of plastic fragmentation once exposed in the environment due to photodegradation/or weathering.

Plastics that escapes to the environment can have various land-based and ocean-based sources. The main on-land-based sources is the uncontrolled dumping of waste, which is usually the result of littering by public members from day-to-day and recreational activities, and of the absence of waste management systems. Additionally, plastics can end up in the environment in two ways; (1) through direct dumping of plastics into the terrestrial and/or surface aquifers including high amounts of plastics dumped directly into the rivers, and (2) through non-engineered landfills or dumpsites after collection.

Table 1.4 Plastic and microplastic losses to the environment.

Study	Million Tons of Plastic Losses to the Environment	Million Tons of Microplastic Losses to the Environment
Ryberg et al. (2019)	9.2	3.0
UN Environment (2018c)	8.28	3.01
Boucher and Friot (2017)	–	3.5

Table 1.5 Collected items from the top 10 most found items made of plastic.

Items	Quantities (tons)
Cigarette butts	5 716 331
Food wrappers	3 728 712
Straw stirrers	3 668 871
Forks, knives, spoons	1 968 065
Plastic beverage bottles	1 754 908
Plastic bottle cups	1 390 232
Plastic grocery bags	964 541
Other plastic bags	938 929
Plastic lids	728 892
Plastic cups and plates	656 276

Source: Ocean Conservancy (2019)

Suffice to say that plastic waste is now accumulated in landfills and in the natural environment. However, the number of landfills in some locations is exponentially increasing, which means less space is available. Also, in the future, because of the longevity of plastics, disposal to landfills may become problematic resulting in a significant source of contaminants to aquatic environments. **Coastline (Beach)**, an ocean conservancy, holds a long record of items collected during annual Beach Cleanup activities around the globe since the 1980s. The International Coastal Cleanup was organized in 2018 with 1 080 358 volunteers who removed 10 584 tons of litter, totaling 35.9 km of coastline around the world. Of the collected items, the top 10 most found items were made of plastic (including cigarette butts, which contain plastics filters) as shown in [Table 1.5](#).

Along the Algerian coast, the National Waste Agency reported that nearly 81% of the collected waste is plastics, mainly single-use plastics. Due to the circular ocean currents, plastics can be moved and transported worldwide. Floating plastic waste has been shown to accumulate in five subtropical gyres that cover 40% of the world's oceans. Several researchers have made attempts to provide the number of plastics entering the environment and the sea each year. It is reported that more than 10 million tons of plastics enter the ocean per year, with an estimated 40% of that falling into the single-use category, while hundreds of thousands of tons of lost, abandoned and discarded fishing gear litter the world's oceans. Microplastics account for around 1.5 million tons of plastics entering the ocean in [Table 1.6](#).

Table 1.6 Plastics and microplastics entering the marine environment.

Study	Plastics (million tons)	Microplastics (million tons)
Jambeck et al. (2015)	4.8–12.7	N/a
EUNOMIA (2016)	12.0	0.95
Boucher and Friot (2017)	10	1.5

According to [Boucher and Friot \(2017\)](#), most of the global plastics leakage into the ocean comes from China (2.21 million tons per year), followed by India and South Asia (1.99 million tons per year). Macroplastics in the marine environment are expected to have the same composition as the macroplastics found on the coastline, including abandoned and discarded fishing gear. Microplastics in the marine environment mainly come from washing synthetic textiles followed by tiny bits of tire rubber material due to wearing down of car tires.

1.4.3 Degradation of plastics in the environment

Degradation is the partial or complete breakdown of a polymer under the influence of environmental factors such as water, heat, light, microbes, and mechanical actions. Most polymeric materials that enter the environment are subjected to degradation caused by a combination of factors, including thermal oxidation, photo-oxidative degradation, biodegradation, and hydrolysis. Plastics are man-made long-chain polymeric molecules. Over time, the stability and durability of plastics change continuously. Any physical or chemical change in the polymer is caused by environmental factors, such as light, heat, moisture, chemical conditions, or biological activity. Degradation of plastic polymers can generally be classified as biotic or abiotic, following different mechanisms, depending on a variety of physical, chemical, or biological factors. Polymers are converted into smaller molecular units (e.g., oligomers, monomers, or chemically modified versions) and possibly are completely mineralized. The important processes for the degradation of polymers include physical degradation (abrasive forces, heating/cooling, freezing/thawing, wetting/drying), photodegradation (usually by ultraviolet radiation (UV) light), chemical degradation (oxidation or hydrolysis) and biodegradation by organisms (bacteria, fungi, algae).

1.4.3.1 Hydrolytic degradation

Most polymers such as polyolefins, including PE, PP and copolymers, are hydrophobic. Other vinyl polymers, such as PS and halogenated vinyl polymers, and for most rubbers are also hydrophobic. In general, polymers with pure carbon backbones are particularly resistant to most types of degradation. Hydrolysis is the cleavage of bonds in functional groups by reaction with water. This reaction occurs mainly in polymers that take up a lot of moisture and that have water-sensitive groups in the polymer backbone. The rate of hydrolytic degradation can vary from days to years depending on the type of functional group, structure, morphology, and pH. Some synthetic polymers that degrade when exposed to moisture include polyesters, polyanhydrides, polyamides, polyethers and polycarbonates ([Gewert *et al.*, 2015](#)).

1.4.3.2 Thermo-oxidative degradation

Temperatures and oxygen levels affect plastics. Certain plastics will fragment more rapidly in regions with higher temperatures. High temperatures increase the rate of chemical reaction, generating greater degradation. There are reports that PS or polycarbonate has the possibility of thermal degradation under the subtropical condition (30–50°C). The light-initiated oxidative degradation is accelerated at higher temperatures depending on the process's activation energy

(E_a); for example, for an E_a of about 50 kJ/mol, the rate of degradation doubles when the temperature rises by only 10°C. Activation energy is the minimum amount of energy required to initiate a reaction in which it is the height of the potential energy barrier between the potential energy minima of the reactants and products. Activation energy is denoted by E_a and typically has units of kilojoules per mole (kJ/mol) or kilocalories per mole (kcal/mol).

1.4.3.3 Photo-degradation

Most plastics degrade primarily through photo-degradation in the environment. UV radiation in sunlight (100–400 nm) plays a key role in photo-oxidation, which induces plastic degradation. The photo-oxidative degradation of common polymers such as LDPE, HDPE, PP, and aliphatic polyamides (nylons) exposed to the environment is predominantly caused by UV-B radiation (280–315 nm) from sunlight. Once started, the breakdown can accelerate thermo-oxidatively for a while without the need for more UV exposure. If oxygen is accessible in the solution, the autocatalytic degradation reaction sequence can continue. The molecular weight of the polymer is reduced during photo-degradation, and oxygen-rich functional groups are formed in the polymer.

1.4.3.4 Biodegradation

The conventional polymers such as PE, PP, PS, PET, nylons, PVC, and the composites and/or blends of these polymers prolong biodegradation rates and thus remain semi-permanently disposed of in the sea. The microbial species that can metabolize these polymers are rare in nature. Several features of PE make it resistant to biodegradation. Among these features are (1) highly stable C–C and C–H covalent bonds; (2) high molecular weight, which makes it too large to penetrate the cell walls of microbes; (3) lack of readily oxidizable and/or hydrolyzable groups; and (4) highly hydrophobic nature.

Bacteria and fungi are involved in the degradation of both natural and synthetic plastics. The biodegradation of plastics proceeds actively under different soil conditions according to the properties because the microorganisms responsible for the degradation and optimal growth conditions in the soil differ from each other, including polymer characteristics, type of organism, and nature of pretreatment. In the degradation process, the polymer is first converted to its monomers, and then these monomers are mineralized. The initial breakdown of a polymer can result from a variety of physical and biological forces. Physical forces, such as heating/cooling, freezing/thawing, or wetting/drying, can cause mechanical damage such as cracking of polymeric materials.

During degradation, exo-enzymes from microorganisms break down complex polymers yielding smaller molecules of short chains, for example, oligomers, dimers, and monomers, that are small enough to pass the semi-permeable outer bacterial membranes, and then to be utilized as carbon and energy sources. Environmental conditions often determine dominant groups of microorganisms and the degradative pathways associated with polymer degradation. When O_2 is available, aerobic microorganisms are mostly responsible for the destruction of complex materials, with microbial biomass, CO_2 , and H_2O as the final products. In contrast, under anoxic conditions, anaerobic consortia

Table 1.7 Various polymer degradation routes.

Factors (Requirement/Activity)	Photo-Degradation	Thermo-Oxidative Degradation	Biodegradation
Active agent	UV-light or high-energy radiation	Heat and oxygen	Microbial agents
Requirement of heat	Not required	Higher than the ambient temperature required	Not required
Rate of degradation other consideration	Initiation is slow. But propagation is fast	Fast	Moderate
Other considerations	Environment friendly if high-energy radiation is not used	Environmentally not acceptable	Environment friendly
Overall acceptance	Acceptable but costly	Not acceptable	Cheap and very much acceptable

of microorganisms are responsible for polymer deterioration. The primary products will be microbial biomass, CO₂, CH₄, and H₂O under methanogenic (anaerobic) conditions (Dussud *et al.*, 2018).

1.4.3.5 Mechanical degradation

Mechanical degradation can happen through the combined efforts of wave and tide action, and abrasion of sediment particles, which can scratch the surface of the plastics and increase its rate of fragmentation. In most cases, the aging of the polymer by environmental influences, such as photo-degradation or chemical degradation of additives, changes the polymer properties and leads to the embrittlement of the polymer. This degradation generally leads to smaller plastic particles, with sizes between 1 and 5000 μm . Such particles are classified as microplastics. However, mechanical degradation can lead to nano-plastics when the plastic particles are reduced to the size range smaller than that of microplastics.

1.4.3.6 Combined degradation processes

The degradation of the most common plastics encountered in the environment is attributed to the combined actions of sunlight, atmospheric oxygen, and seawater. Among the degradation processes involved, the most important is photo-oxidation, followed by mechanical action and thermal oxidation, and to a lesser degree, biodegradation and hydrolysis in Table 1.7.

REFERENCES

- Andrady A. L. and Neal M. A. (2009). Applications and societal benefits of plastics. *Philosophical Transactions of the Royal Society B: Biological Sciences*, **364**(1526), 1977–1984, <https://doi.org/10.1098/rstb.2008.0304>

- Areeprasert C., Asingsamanunt J., Srisawat S., Kaharn J., Insemeesak B., Phasee P., Khaobang C., Siwakosit W., Chiemchaisri C. (2017). Municipal plastic waste composition study at transfer station of Bangkok and possibility of its energy recovery by pyrolysis. *Energy Procedia*, **107**, 222–226.
- Arutchelvi J., Sudhakar M., Ambika Arkatkar, Dhoble M., Bhaduri S. and Uppara P. V. (2008) Biodegradation of polyethylene and polypropylene. *Indian Journal of Biotechnology*, **7**, 9–22.
- Boucher J. and Friot D. (2017). Primary Microplastics in the Oceans : a Global Evaluation of Sources (Vol. 10). IUCN, Gland, Switzerland. <https://doi.org/10.2305/IUCN.CH.2017.01.en>
- Bowers T., Vaidya A., Smith D. A. and Lloyd-Jones G. (2014). Softwood hydrolysate as a carbon source for polyhydroxyalkanoate production. *Journal of Chemical Technology & Biotechnology*, **89**(7), 1030–1037, <https://doi.org/10.1002/jctb.4196>
- Brodin M., Vallejos M., Opedal M. T., Area M. C. and Chinga-Carrasco G. (2017). Lignocellulosics as sustainable resources for production of bioplastics – a review. *Journal of Cleaner Production*, **162**, 646–664, <https://doi.org/10.1016/j.jclepro.2017.05.209>
- de Souza Machado A. A., Kloas W., Zarfl C., Hempel S. and Rillig M. C. (2018). Microplastics as an emerging threat to terrestrial ecosystems. *Global Change Biology*, **24**(4), 1405–1416.
- Dussud C., Meistertzheim A L., Conan P., Pujó-Pay M., George M., Fabre P., Coudane J., Higgs P., Elineau A., Pedrotti M. L., Gorsky G. and Ghiglione J. F. (2018). Evidence of niche partitioning among bacteria living on plastics, organic particles and surrounding seawaters. *Environmental Pollution*, **236**, 807–816.
- Edmondson S. and Gilbert M. (2017). The chemical nature of plastics polymerization. In: Brydson's Plastics Materials, M. Gilbert (ed). 8th edn, Elsevier, Oxford, pp. 19–37.
- EPA (2021). <https://www.epa.gov/facts-and-figures-about-materials-waste-and-recycling/plastics-material-specific-data>
- Eunomia (2016). Plastics in the Marine Environment. Eunomia Research & Consulting Ltd, Bristol, UK.
- European Bioplastics (2020). Bioplastics Market Development Update 2020. European Bioplastics Conference, Hürth, Germany. https://docs.european-bioplastics.org/conference/Report_Bioplastics_Market_Data_2020_short_version.pdf
- European Bioplastics, Nova-Institute (2018). Bioplastics market data 2018. *Global production capacities of bioplastics 2018-2023 report*. European Bioplastics, Berlin, Germany. https://www.european-bioplastics.org/wp-content/uploads/2016/02/Report_Bioplastics-Market-Data_2018.pdf
- Gewert B., Plassmann M. M. and MacLeod M. (2015). Pathways for degradation of plastic polymers floating in the marine environment. *Environmental Science: Processes & Impacts*, **17**(9), 1513–1521.
- Geyer R., Jambeck J. R. and Law K. L. (2017). Production, use, and fate of all plastics ever made. *Science Advances*, **3**(7), e1700782, <https://doi.org/10.1126/sciadv.1700782>
- Gilbert M. (2017). Plastics materials: introduction and historical development. In: Brydson's Plastics Materials. 8th edn, Elsevier, Oxford, pp. 1–18.
- Hammer J., Kraak M. H. S. and Parsons J. R. (2012). Parsons, plastics in the marine environment: the dark side of a modern gift. In: Reviews of Environmental Contamination and Toxicology, D. M. Whitacre (ed.), Springer, New York, pp. 1–44.
- Hansen E., Nilsson N. H. and Vium K. S. R. (2014). Hazardous Substances in Plastics. Danish Ministry of the Environment, Environmental Protection Agency, Copenhagen, p. 181.
- Horton A. A., Walton A., Spurgeon D. J., Lahive E. and Svendsen C. (2017). Microplastics in freshwater and terrestrial environments: evaluating the current understanding

- to identify the knowledge gaps and future research priorities. *Science of the Total Environment*, **586**, 127–141, <https://doi.org/10.1016/j.scitotenv.2017.01.190>
- Jambeck J. R., Geyer R., Wilcox C., Siegler T. R., Perryman M., Andrady A., Narayan R. and Law K. L. (2015). Plastic waste inputs from land into the ocean. *Science*, **347**(6223), 768–771, <https://doi.org/10.1126/science.1260352>
- Kershaw P. J. (2016). Marine Plastic Debris and Microplastics – Global Lessons and Research to Inspire Action and Guide Policy Change. United Nations Environment Programme (UNEP), Nairobi, p. 252.
- Kershaw P. J. and Rochman C. M. (2015). Sources, fate and effects of microplastics in the marine environment: part 2 of a global assessment. Reports and Studies-IMO/FAO/Unesco-IOC/WMO/IAEA/UN/UNEP Joint Group of Experts on the Scientific Aspects of Marine Environmental Protection (GESAMP). Eng No. 93.
- Koelmans A. A., Besseling E. and Foekema E. M. (2014). Leaching of plastic additives to marine organisms. *Environmental Pollution*, **187**, 49–54.
- Kole P. J., Löhr A. J., Van Belleghem F. G. and Ragas A. M. (2017). Wear and tear of tyres: a stealthy source of microplastics in the environment. *International Journal of Environmental Research and Public Health*, **14**(10), 1265, <https://doi.org/10.3390/ijerph14101265>
- Lebreton L. and Andrady A. (2019). Future scenarios of global plastic waste generation and disposal. *Palgrave Communications*, **5**(1), 1–11.
- Lebreton, L., Egger, M. and Slat, B. (2019). A global mass budget for positively buoyant macroplastic debris in the ocean. *Scientific Reports*, **9**(1), 1–10.
- Napper I. E., Bakir A., Rowland S. J. and Thompson R. C. (2015). Characterisation, quantity and sorptive properties of microplastics extracted from cosmetics. *Marine Pollution Bulletin*, **99**(1–2), 178–185, <https://doi.org/10.1016/j.marpolbul.2015.07.029>
- Niaounakis M. (2017). Management of Marine Plastic Debris: Prevention. Recycling and Waste Management William Andrew Applied Science Publishers, Oxford, UK and Cambridge, USA.
- Ocean Conservancy (2019). Together, We are Team Ocean. International Coastal Cleanup Report. Washington, D.C. USA.
- Oehlmann J., Schulte-Oehlmann U., Kloas W., Jagnytsch O., Lutz I., Kusk K. O., Wollenberger L., Santos E. M., Paull G. C., Van Look K. J. W. and Tyler C. R. (2009). A critical analysis of the biological impacts of plasticizers on wildlife. *Philosophical Transactions of the Royal Society B: Biological Sciences*, **364**(1526), 2047–2062, <https://doi.org/10.1098/rstb.2008.0242>
- Petsko E. (2020). Recycling Myth of the Month: Those numbered symbols on single-use plastics do not mean ‘you can recycle me’ article. <https://oceana.org/blog/recycling-myth-month-those-numbered-symbols-single-use-plastics-do-not-mean-you-can-recycle-me/>
- Plastics Europe (2018). Plastics the Facts 2018 – An Analysis of European Plastics, Production, Demand and Waste Data. Plastics Europe, Brussels, p. 60.
- Rahman A. and Syamsu K. (2018). Biodegradability of oil palm cellulose-based bioplastics. *IOP Conference Series: Earth and Environmental Science*, **183**, 12012, <https://doi.org/10.1088/1755-1315/131/1/012012>
- Ru J., Huo Y. and Yang Y. (2020). Microbial degradation and valorization of plastic wastes. *Frontiers in Microbiology*, **11**, 442, <https://doi.org/10.3389/fmicb.2020.00442>
- Ryberg M. W., Hauschild M. Z., Wang F., Averous-Monnery S. and Laurent A. (2019). Global environmental losses of plastics across their value chains. *Resources, Conservation and Recycling*, **151**, 104459.
- Sangale M. K., Shah Nawaz M. and Ade A. B. (2012). A review on biodegradation of polythene: the microbial approach. *Journal of Bioremediation and Biodegradation*, **3**(10), 1–9, <https://doi.org/10.4172/2155-6199.1000164>

- SAPEA (Science Advice for Policy by European Academies) (2019). A Scientific Perspective on Microplastics in Nature and Society. SAPEA, Berlin, p. 176.
- Shah A. A., Hasan F., Hameed A. and Ahmed S. (2008). Biological degradation of plastics: a comprehensive review. *Biotechnology Advances*, **26**(3), 246–265.
- Talsness C. E., Andrade A. J., Kuriyama S. N., Taylor J. A. and Vom Saal F. S. (2009). Components of plastic: experimental studies in animals and relevance for human health. *Philosophical Transactions of the Royal Society B: Biological Sciences*, **364**(1526), 2079–2096, <https://doi.org/10.1098/rstb.2008.0281>
- Thompson R. C., Moore C. J., Vom Saal F. S. and Swan S. H. (2009). Plastics, the environment and human health: current consensus and future trends. *Philosophical Transactions of the Royal Society B: Biological Sciences*, **364**(1526), 2153–2166, <https://doi.org/10.1098/rstb.2009.0053>
- UNEP (2015). Biodegradable Plastics and Marine Litter. Misconceptions, Concerns and Impacts on Marine Environments. United Nations Environment Programme (UNEP), Nairobi, Kenya.
- United Nations Environment Programme (2016). Marine Plastic Debris and Microplastic: Global Lessons and Research to Inspire Action and Guide Policy Change. UN, New York City, USA.
- UNEP (2018a). SINGLE-USE PLASTICS: A Roadmap for Sustainability.
- UNEP (2018b). The State of Plastics: World Environment Day Outlook. United Nations Environment Programme (UNEP), Nairobi, p. 16.
- UNEP (2018c). Mapping of Global Plastics Value Chain and Plastics Losses to the Environment: With a Particular Focus on Marine Environment, Ryberg, M., Laurent, A., Hauschild, M (eds.). UNEP, Nairobi, Kenya.
- UNEP (2020). Plastic Waste Background Report, *Plastic Waste Partnership Working Group Meeting*. Beau Vallon, Seychelles.
- US EPA (2016). Advancing Sustainable Materials Management: 2016 Recycling Economic Information (REI) Report, National Recycling Coalition (NRC). Washington DC, USA.
- Varda M., Nishith D., and Darshan M. (2014). Production and evaluation of microbial plastic for its degradation capabilities. *Journal of Environmental Research and Development*, **8**(4), 934
- World Economic Forum (2016). The New Plastics Economy: Rethinking the Future of Plastics. Ellen MacArthur Foundation, Isle of Wight, UK. newplasticseconomy.org/about/publications
- Zhu Y., Romain C. and Williams C. K. (2016). Sustainable polymers from renewable resources. *Nature*, **540**, 354–362, <https://doi.org/10.1038/nature21001>

Chapter 2

Plastic litters and public health

Chongrak Polprasert, Thammarat Koottatep, Tatchai Pussayanavin, Kesirine Jinda and Sittikorn Kamngam

Table of Contents

2.1	Sources, Occurrence, Fragmentation and Degradation of Plastic Litters	26
2.1.1	Entry routes into the environment and food chain	26
2.1.2	Plastic litter in the environment and food chains	27
2.2	Fragmentation and Degradation of Plastic Litter	42
2.2.1	Definition of plastic fragmentation and degradation.	42
2.2.2	Influence of plastic fragmentation and degradation on its adverse effects	42
2.3	Bioaccumulation and Biomagnification	44
2.3.1	Definition of bioaccumulation and biomagnification	44
2.3.2	Bioaccumulation of plastics in the food web	46
2.3.3	Biomagnification of plastic litter in the food web	50
2.4	Ecological Toxicity of Plastics	55
2.4.1	Fundamentals of toxicology and the environment.	55
2.4.2	Ecological toxicity and impacts of plastics.	56
2.4.3	Differential risk of marine litter interactions across the oceanic gradient	57
2.4.4	Toxicity of plastic and carried substance in aquatic life	59
2.4.5	Ecotoxicological assessment of MPs	62
2.5	Effects of MPs on Human Health	64
2.5.1	Plastic litter exposure pathways.	64
2.5.2	Public health effects of plastic additives	64
2.5.3	Toxicity of MPs.	65
2.5.4	Potential for and factors that may affect bioaccumulation	67
2.5.5	Toxicity of MP particles to cells and tissues	68
2.5.6	Human health effects of plastic additives (consumer use)	70

© 2023 The Authors. This is an Open Access book chapter distributed under a Creative Commons Attribution Non Commercial 4.0 International License (CC BY-NC 4.0), (<https://creativecommons.org/licenses/by-nc/4.0/>). The chapter is from the book *Marine Plastics Abatement: Volume 1. Challenges, Implications, Assessments and Circularity*, Thammarat Koottatep, Ekborderin Winijkul, Wenchao Xue, Atitaya Panuvatvanich, Chettiyappan Visvanathan, Tatchai Pussayanavin, Nantamol Limphitakphong and Chongrak Polprasert (Eds).

2.5.7	Potential threats associated with accumulated pollutants in plastic particles	71
2.5.8	Food packaging chemicals	72
2.5.9	Human health effects related to plastic waste management.	72
2.6	Impact of MP on Human Health	73
2.6.1	Ingestion	73
2.6.2	Ingesting MP particles.	74
2.6.3	MPs and toxic chemicals.	75
2.6.4	MP and the potential for disease	75
2.6.5	Inhaling MPs	76
2.6.6	Skin contacts of plastics in agricultural soil.	76
2.6.7	Human illnesses and disabilities caused by MPs and carried chemicals.	76
2.6.8	Standards and guidelines for preventing the effects of plastics and MPs	76
	References.	78

2.1 SOURCES, OCCURRENCE, FRAGMENTATION AND DEGRADATION OF PLASTIC LITTERS

2.1.1 Entry routes into the environment and food chain

When plastics enter the environment as macro- or microplastic (MP), they break into small particles over time, contaminating all areas of the environment (air, water, and soil), accumulating in food chains, releasing toxic additives or concentrating additional toxic chemicals in the environment, and rendering them bioavailable for direct or indirect human exposure.

Plastic litter is ubiquitous in the environment in various sizes. As a result, the health effects and exposure routes of plastic pollution depend on the sizes ranging from ‘nano-particles’ to ‘macroplastics.’

‘**Macroplastics**’ are generally defined as plastic items larger than 5 mm.

‘**Microplastics**’ are generally recognized as synthetic organic polymer particles less than 5 mm at their longest point.

‘**Nanoplastics**’ are generally defined as plastic items with sizes between 1 and 100 nm.

- **Macroplastics**

Macroplastics can be distributed in aquatic, terrestrial and atmospheric environments via different transport routes such as wind and water currents (Lechthaler *et al.*, 2020). The details of transport paths of macroplastics in different environmental compartments are provided in Chapter 4.

The majority of micro-plastics discovered in the ocean are ‘original consumer items.’ The plastic items that reach the environment are listed in a recent collection of the top 20 most prevalent products detected in six separate worldwide sets of coastal data. Food and beverage packaging (such as wrappers), bottles and bottle caps, straws, stirrers, lids, cutlery, containers, cups, and plates account for 75% of the items on the list. The

remaining items include smoking-related items (cigarette butts, packaging, and lighters), as well as bags, balloons, diapers, condoms, tampons, and six-pack holders.

- **Microplastics**

Microplastics (MPs) that enter the environment can be defined as both ‘primary and/or secondary microplastics.’

- *Primary MPs* are defined as MP produced as ‘original products in micro-sizes’. This includes pre-production plastic in the form of powders and pellets (5 mm in size) used in producing plastic consumer products. MPs are leaked from processing and transportation facilities, mostly as a result of poor housekeeping standards during the shift from rail, truck, and storage sites to processing facilities. Microbeads, which are found in hand cleansers, face cleansers, and toothpaste, are another form of primary MPs.
- *Secondary MPs* are the ‘degraded plastic pieces of larger consumer products.’ Common MPs reported in many studies on shoreline litter are degradants of textile fibers and particles from automobile tires which originally are macro-sized plastic products.

Studies have shown that MP particles are commonly found in personal care products, accounting for a range between 0.05% and 12% of the ingredients. As a result, many countries such as the United States, Canada, Australia, the United Kingdom, New Zealand, Taiwan, and Italy now have banned the primary MPs in production of personal care products.

- **Nanoplastics**

Nanoplastics are being more widely used in paints, adhesives, medicines, electronics, and 3D printing. These are then released into the environment as primary nanoplastics products. Secondary nanoplastics result from continued degradation of MPs, similar to the secondary MP process.

2.1.2 Plastic litter in the environment and food chains

2.1.2.1 Numbers and characteristics of plastic litter in the food chains

It has been commonly reported recently that humans are becoming exposed to plastic pollution. The abundance and concentration of plastic litter found in different places are key factors causing adverse impacts on human health via the food chain. According to recent research findings, ‘humans can easily be exposed to micro and nanoplastics in three ways: drinking contaminated water, consuming contaminated food and breathing polluted air’ (WHO, 2019). All kinds of plastics, namely macro-, micro- and nano-plastics can be found in the environment and the food chain.

2.1.2.2 Numbers and characteristics of MPs (MaP)

As macroplastics occur and accumulate in different environmental compartments, their numbers and concentrations significantly lead to different levels of health risk. In the case of macroplastics, concentration in the environment can be found in freshwater, marine, and terrestrial environments. An estimated 1.15–2.41 million tons of plastic waste depending on waste

management, population density, and hydrological information was reported in 2017 alone (Lechthaler *et al.*, 2020).

Moreover, it has been reported that 91% of mismanaged plastic waste in the African and Asian continents were transported and accumulated along waterways, making rivers the main input path leading plastic waste into the oceans as shown in Table 2.1 (Lechthaler *et al.*, 2020).

Table 2.1 Abundance of MPs in freshwater.

Environment	Environmental Compartments	Study Area (Year)	Average MP Concentration/ Input/Year	References
Freshwater	River and sea	Italy; the Tiber (2018)	87 600–438 000 items	Crosti <i>et al.</i> (2018)
		South-East: Vietnam, Indonesia, Thailand, Malaysia (2019)	8.76–87.60 million items	van Calcar and van Emmerik (2019)
		Europe: Italy, The Netherlands, France (2019)	0.88–876 million items	van Calcar and van Emmerik (2019)
		France; the Rhone the Seine (2019)	0–175 200 items 0.93–1.40 million items	Van Emmerik <i>et al.</i> (2019)
		Vietnam; the Saigon River (2018)	7500–13 700 tons	Van Emmerik <i>et al.</i> (2019)
		Black Sea (2014)	1533 tons	Lechner <i>et al.</i> (2014); Lechthaler <i>et al.</i> (2020)
		The North Sea by; the Elbe the Ems the Weser (2020)	Up to 451 tons Up to 1.60 tons Up to 6.30 tons	Schöneich-Argent <i>et al.</i> (2020)
		The ocean; Discharging by two Catalan rivers, Llobregat and El Beses (2020)	0.40–0.60 tons	Schirinzi <i>et al.</i> (2020)
		Switzerland; the Rhine (2020)	0.88–0.66 million items	Vriend <i>et al.</i> (2020)
		Lakes	Switzerland; six lakes	1800 items/km ²

2.1.2.3 Numbers and characteristics of MPs

MPs enter the human body through the water we drink, the food we eat, and the air we breathe, according to a WHO report released in 2019 (Figure 2.1). MPs' presence in numerous environmental compartments, such as water, soil, air, and organisms, increases the number of possible routes by which humans and animals are exposed. This could link to potential sources of transportation pathways and its adverse effects on animals and human health.

- **MPs in tap water**

The presence of MPs in the water sources of water supply (surface water, reservoir, dam, etc.) resulted in the abundance of MPs in tap water. Several investigations have confirmed the contamination of MPs in tap water worldwide (Figure 2.2). Previous studies (as summarized in Table 2.2) investigated 159 tap water samples from 14 countries, half of which were developed countries and half were developing countries. The results showed 81% of all samples contain a range of 0–61 particles/L of MPs with an average of 5.45 particles/L. In particular, tap water in the US was found to contain the highest average (9.24 particles/L), while the four countries with the lowest averages were all from the European Union countries. As a result, water from more developed countries had a greater average density (6.85 particles/L) than that from developing countries (4.26 particles/L). The tap water analysis revealed 83% contamination, with microfibers accounting for 98% of the particles. Figure 2.3 shows the examples of anthropogenic particles found in tap water samples from the Indian subcontinent and the US.

- **Drinking water**

Studies of MPs contamination in treated tap water and drinking water and its potential impact on human health have recently grown in number. MPs found in drinking water are a silent problem that threatens people's health globally. MPs in commercially bottled water have been reported to be two times more abundant than MPs found in tap water.

A study found that over 90% of the world's most popular bottled water brands contain MPs. With these findings, the World Health Organization (WHO) has emphasized the potential risks of MPs in drinking water. According to the McCarthy (2018) study, 259 bottles bought in 8 different countries, including China, Brazil, India, Indonesia, Mexico, Lebanon, Kenya, Thailand, and the United States, across 11 leading brands were examined.

The results showed that the water in the 242 bottles was found to contain an average of 325 MP particles/L, while only 17 bottles were confirmed to be plastic-free (Figure 2.4). Thus, MP contamination was found in over 93% of the bottled water samples. A bottle of Nestlé Pure Life, for instance, contained almost 10 000 particles of MPs, while Bisleri, Gerolsteiner, and Aqua bottles all had significant quantities (Mason *et al.*, 2018). The bottled water was found to be 93% contaminated, with 13% of the particles classified as microfibers. Polypropylene, nylon, and PET were among the plastics found in the bottled water samples. Furthermore, the study revealed that fragments were the most

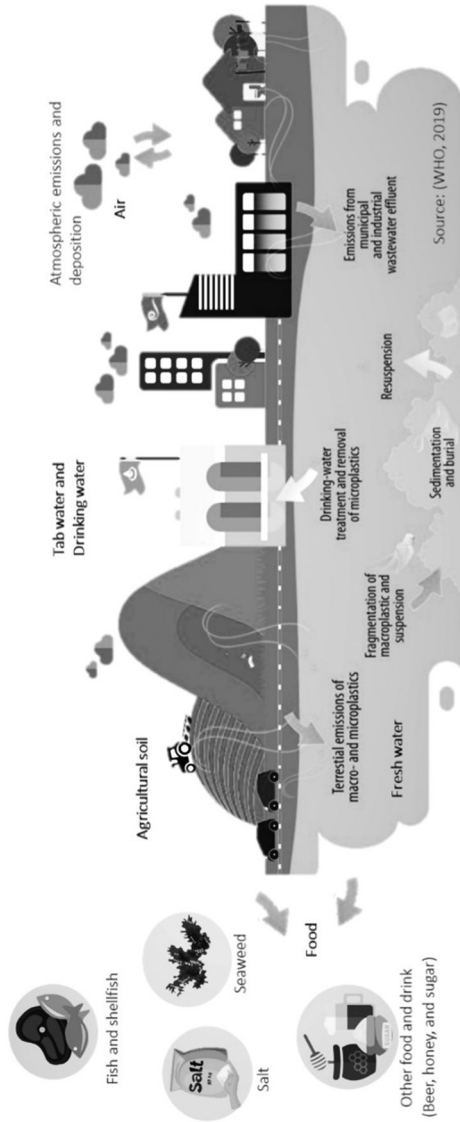

Figure 2.1 MP entering the human body through the water we drink, the food we eat, and the air we breathe (Source: adapted from WHO, 2019).

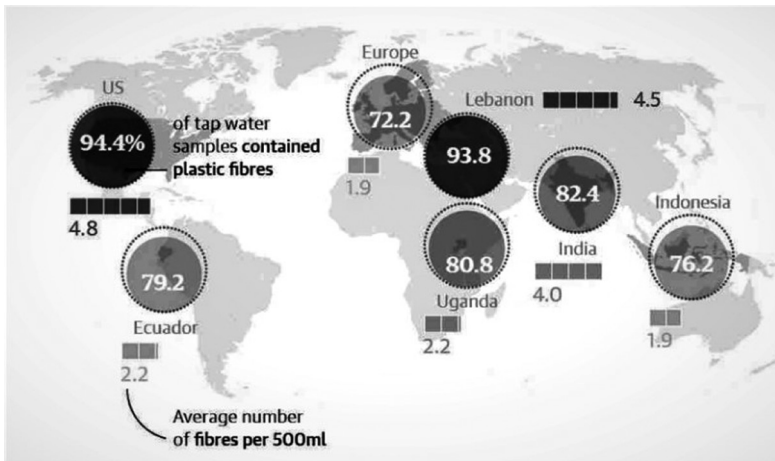

Figure 2.2 Percent of tap water samples contaminated with MPs by country (Source: Picó & Barceló, 2019).

Table 2.2 MPs concentration in tap water.

Country/Sources	Number of Samples	MPs Concentration (Particles/L) ^a
Cuba	1	7.17 ± 0.00
Ecuador	24	4.02 ± 3.20
England	3	7.73 ± 4.76
France	1	1.82 ± 0.00
Germany	2	0.91 ± 1.29
India	17	6.24 ± 6.41
Indonesia	21	3.23 ± 3.48
Thailand	NA	0.56 ± 0.24
	6	0.62 ± 0.38
Ireland	1	1.83 ± 0.00
Lebanon	16	6.64 ± 6.38
Slovakia	8	3.83 ± 4.47
Switzerland	2	2.74 ± 3.87
Uganda	26	3.92 ± 3.17
USA	33	9.24 ± 11.8
Bottled water	3	3.57 ± 1.79

Note: For countries with only one sample, the density of anthropogenic debris is provided as the mean with no values given for min., max., or standard deviation.

Source: Kosuth *et al.* (2018); Chanpiwat and Damrongsiri (2021).

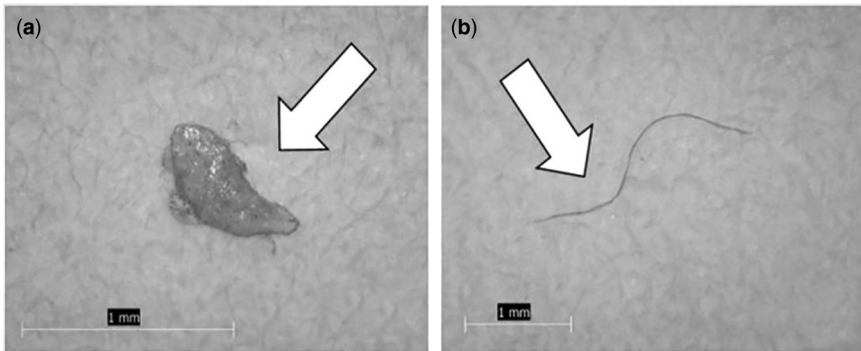

Figure 2.3 Tap water particles. Examples of anthropogenic particles found in tap water: (a) fragment, 1 mm in length from the Indian subcontinent; (b) fiber, 2.5 mm in length from the U.S. tap water sample (Source: Kosuth *et al.*, 2018).

common MPs form detected in bottled water samples (65%), which were likely produced by a different source of contamination than tap water. Polypropylene was the most popular polymeric material for particles bigger than 100 μm (54%), which is similar to the most common plastic used for bottle caps. Nestle Pure Life water, which can be purchased on Amazon.com, had the highest average MP density, at 2247 particles/L. The number and properties of MPs can be linked to their origins and possible effects on ecosystems and human health. Despite the lack of proof that consumption of these MPs might cause health concerns, it has lately been a source of concern.

- **Food**

MPs and associated hazardous compounds in plastic food packaging and drinking water are significant sources of food contamination. However, contamination extends beyond packaged food; natural food chains are also a source of contamination. Both sea-based and land-based food chain contamination requires more research.

- **Fish and Shellfish**

Many studies have investigated the impact of plastics in the ocean. MPs have been found in more than 690 marine species, ranging from small zooplanktons to vast marine animals. Many commercially significant species have also been confirmed to be contaminated with plastic particles. The majority of MP ingestion in humans comes from ‘seafood’ species that are consumed entirely, such as mussels, oysters, shrimp, crabs, and some small fish. MP contamination of seafood may not be limited to ingestion of the species mentioned above; it is possible that other seafood, such as fish muscle tissue, may be contaminated either within the organism or during preparation (Figure 2.5 and Table 2.3).

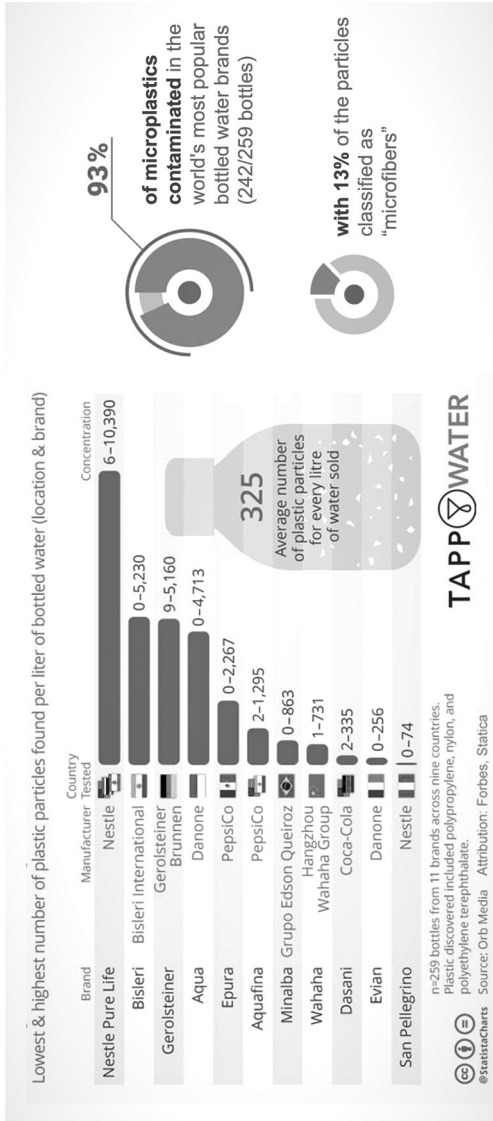

Figure 2.4 Study finds MPs in 93% bottled water (Source: adapted from McCarthy, 2018).

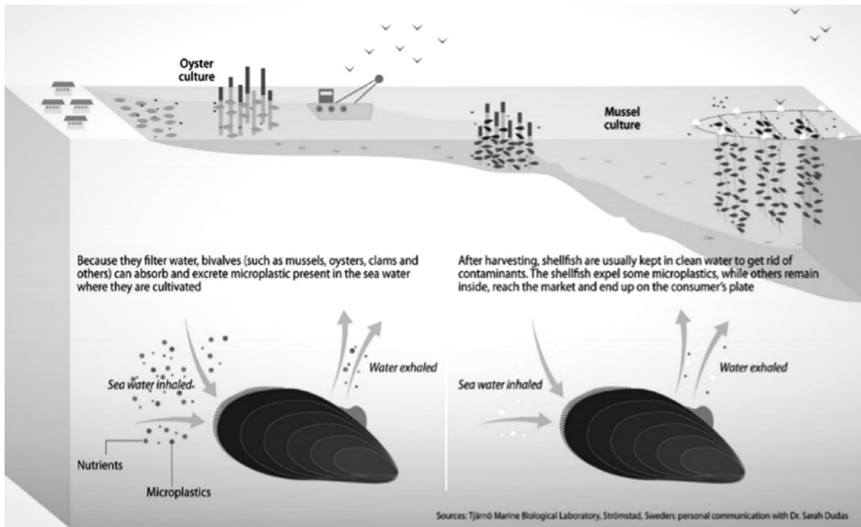







Figure 2.5 An example of how MPs could end up on a consumer's plate (Source: [Smith et al., 2018](#)).

Table 2.3 Examples of MPs in the environment and food chain (MPs in animals and seafood).

Study Area	Animal	Figure	PS Size (μm)	LC ₅₀ * (Items/ind.)	Reference	
Marine Science Department, Chulalongkorn University	Juvenile tiger shrimp (<i>Penaeus monodon</i>)		<30 30–300 300–1000	25 19 19	Phothakwanpracha et al. (2021)	
	Blue swimming crab		PET, PP, PS, Polyester, Nylon	1.30		Fangsrikum et al. (2021)
	Goldstripe sardinella		PET, PE, PP, Nylon	3.90		
Silver sillago		PET, Polyester, Nylon	1.88			
	Green mussels		PET, PE, PP,	0.75		

*Lethal concentration fifty; LC₅₀ (More detail of LC₅₀ is described in 1.3.5: Ecotoxicological Assessment of Microplastics.)

- **Seaweed**

MP particles often attach to the surface of edible seaweed species at high exposure levels, indicating that humans can be exposed to MP through eating seaweed (*Fucus vesiculosus*). The quantity of MP particles was reduced by 94.5% after a thorough wash before using the seaweed for cooking. In China, MPs have been detected in both final commercial seaweed nori products and intermediate products (*Pyropia* spp.) at different processing stages (Figure 2.6). In commercially packaged nori, polyester is the most common MP component. The most common polymer found in factory-processed nori is polypropylene (Table 2.4).

- **Salt**

MPs have been detected in rock salt and sea-salt samples, indicating that there is a high background level of plastic pollution in both marine and terrestrial ecosystems (Figure 2.7). MP contamination in packaged salt and other food products packaged in plastic can also occur during processing and packing. A case study of commercial sea salt from various salt-producing regions was conducted using 12 brands of commercial sea salt. It was found that the MP concentrations of the brands sampled ranged from 46.7 to 806 particles/kg, with a mean of 212 particles/kg (Table 2.5). The color distribution of particles was found that blue and red/pink were prominent colors among all samples (Figure 2.8).

- **Beer**

A study (Kosuth *et al.*, 2018) sampled 12 brands of beer in the USA and found that MPs were detected in all samples with the average particle count for each brand ranging from 0 to 14.3 particles/L, with a mean of 4.05 particles/L (Table 2.6). The vast majority (98.4%) of the 189 particles found were fibers, whereas the remaining were fragments. The fibers measured 0.98 mm on average, with a range of 0.1–5 mm (Figure 2.9). Nine of the 12 beer samples included one or more particles in the second filtration phase, totaling 17 particles among all the samples. In Figure 2.10, blue was the most prominent color among the 189 particles, followed by red/pink and brown, all of which were detected in tap water sample also collected in the study. Although anthropogenic particles were found in both the municipal tap water and the beers sampled, there seemed to be no correlation between the two.

2.1.2.4 Case studies of small MPs and nanoplastic contaminations

The small micro- and nanoplastic contaminations were commonly observed in the environments or in daily used products. Several previous case studies reported and highlighted the contaminations of MPs in the atmosphere, food packaging chemicals and receptors of plastics in the environment and food chains.

- **MPs in the atmosphere**

Because of their small size and low density, MPs are potentially transferred to air and are easily transported by wind. Compared to MPs in other ecosystems,

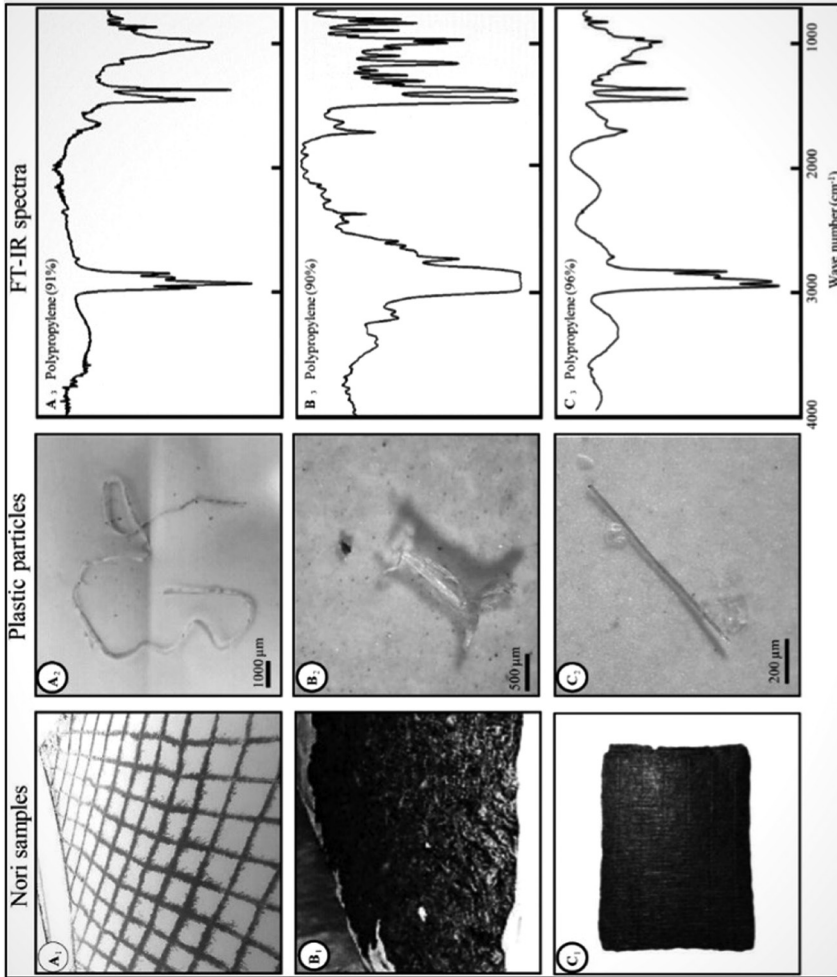

Figure 2.6 MPs in nori samples from factory-processed with optical microscopy and μ -FT-IR spectroscopy. Nori samples in the first column (A₁, B₁, C₁) were photographed from a nori farm site, a nori processing factory, and a dried nori product, respectively. Optical photographs in the second column (A₂, B₂, C₂) showed the plastic particles isolated from different sources to their left ones, and the third column (A₃, B₃, C₃) displayed FT-IR spectra of the corresponding particles to their left ones (Source: [Li et al., 2020](#)).

Table 2.4 MPs in commercial seaweed nori (*Pyropia* spp.)

Sample	The Abundance of MPs, Items/g (dw)	MPs Size, mm	MPs Shape	Types of MPs	Color of MPs
Twenty-four brands of commercially packaged nori in China	0.9–3.0 (average: 1.8 ± 0.7)	0.11–4.97 (median size: 1.13)	Fiber (85.2%)	Polyester (18.9%)	Blue-green (41.4%)
Factory-processed nori	10–2.8 (average: 1.8 ± 0.6)	0.07–4.74 (median size: 0.85)	Fiber (64.8%)	Polypropylene (16.3%)	Blue-green (48.1%)

MPs in the air can be directly and continuously inhaled into the human body, posing serious health risks.

To date, only a few studies have examined the presence of MPs in the atmosphere. In a study conducted in Greater Paris, MPs were detected in air fallout for the first time, with an average of 118 particles/m²/day (Dris *et al.*, 2015). More than 90% of the MPs found were fibers, with 50% of them being longer than 1000 μm . Dris *et al.* (2016) also examined two sites in Paris, reporting that air fallout fibers were present with the concentrations of 110 ± 96 (urban site) and 53 ± 38 (sub-urban site) particles/m²/day (29% MPs). The authors suggested that the variance in MP concentrations in air fallout between the two sites was due to the density of the surrounding population. Dris *et al.* (2017), in their study conducted in Paris, found that indoor fiber concentrations (4.0–59.4 fibers/m³, 33.3% MPs) were greater than outdoor fiber concentrations (0.3–1.5 fibers/m³). MPs are continuously generated by indoor furniture, cleaning practices and activities, and lower rates of indoor air renovation may result

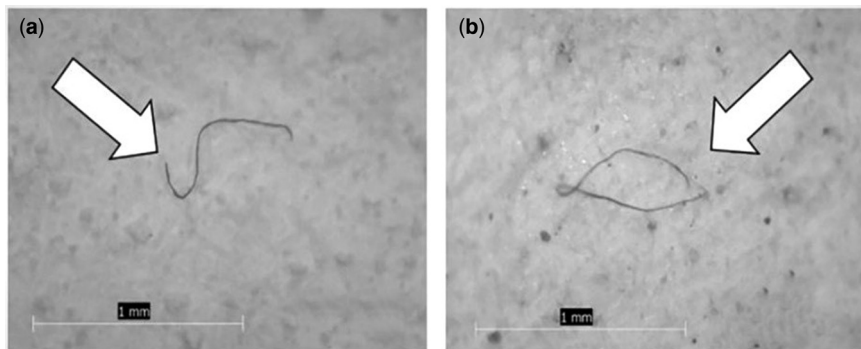

Figure 2.7 Sea-salt particles. Examples of particles found in sea salt: (a) fiber, 1 mm in length from the Pacific Ocean sourced sea salt; (b) fiber, 1.5 mm in length from the Atlantic Ocean sourced sea salt (Source: Kosuth *et al.*, 2018).

Table 2.5 Summary of sea-salt results.

Salt ID	MPs Concentration (Particles/kg) ^a
North Sea salt	66.6 ± 3.61
Celtic Sea salt 1	113 ± 1.53
Celtic Sea salt 2	187 ± 8.19
Sicilian Sea salt	220 ± 2.31
Mediterranean Sea salt 1	133 ± 3.06
Mediterranean Sea salt 2	133 ± 4.16
Utah Sea salt	113 ± 2.08
Himalayan Rock salt	367 ± 12.7
Hawaiian Sea salt	46.7 ± 0.58
Baja Sea salt	173 ± 3.79
Atlantic Sea salt	180 ± 4.16
Pacific Sea salt	806 ± 15.3

in high concentrations of indoor MPs, but the dilution of the air outdoors can greatly reduce MP concentrations.

Cai *et al.* (2017) investigated three sample sites in Dongguan, China and found that the average concentration of MPs in the atmosphere was 367 particles/m²/day. Twenty-three percent of the MPs found were fibers, while

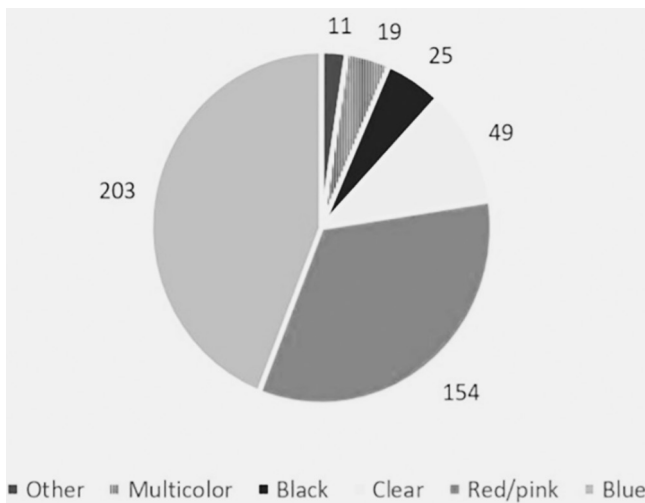

Figure 2.8 Sea salt particle colors. The color distribution of particles was extracted from 12 brands of sea salt (Source: Kosuth *et al.*, 2018).

Table 2.6 Comparison of MP particle count in beer and its corresponding municipal tap water.

Municipality	Number of Particles in Tap Water (Particles/L)	The Average Number of Particles in Beer (Particles/L)
Duluth, Minnesota	1	2.76
Milwaukee, Wisconsin	3	1.30
Chicago, Illinois	2	14.3
Holland, Michigan	2	2.30
Alpena, Michigan	1	1.30
Buffalo, New York	1	3.00
Clayton, New York	1	8.00

Note: ($r = 0.016$), which would seem to indicate that any contamination within the beer is not just from the water used to brew the beer itself.

84.6% of all other forms (films, bits, and foams) (Cai *et al.*, 2017). According to Liu *et al.* (2019b), atmospheric MPs may be detected throughout Shanghai, with a mean concentration of 1.421.42 particles/m³. The lowest concentration was discovered near the sea due to dispersion of MPs by the water or delivery onto land by winds, as well as a lack of significant sources of fibers. MP concentrations were found to be greater at 1.7 m above ground level in the city than they were at 80 m. However, owing to wind mixing in the troposphere, no significant differences in concentrations were identified between the two sites.

Klein and Fischer (2019) reported that during December 2017 and February 2018, a median of 275 particles/m²/day of MPs were detected in atmospheric fallout in Hamburg, Germany, and fragments (95%) were the most common shape of MPs. Abbasi *et al.* (2019) investigated microfibers in Asaluyeh County, Iran and reported that the number of microfibers/m³ ranged from 0.3 to 1.1.

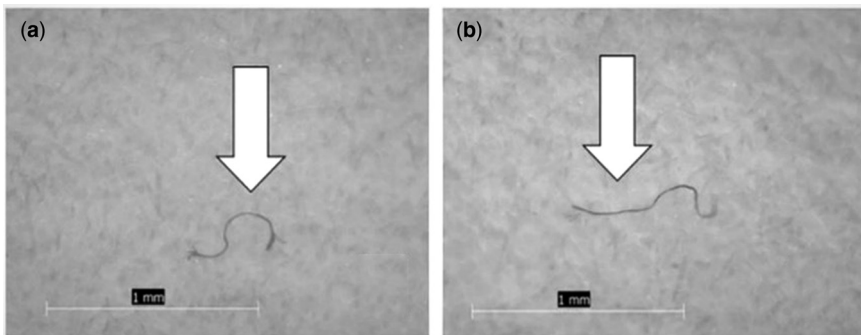

Figure 2.9 Beer particles. Examples of particles found in beer: (a) fiber, 0.75 mm in length from brewery drawing water from Lake Ontario; (b) fiber, 1 mm in length from brewery drawing water from Lake Erie (Source: Kosuth *et al.*, 2018).

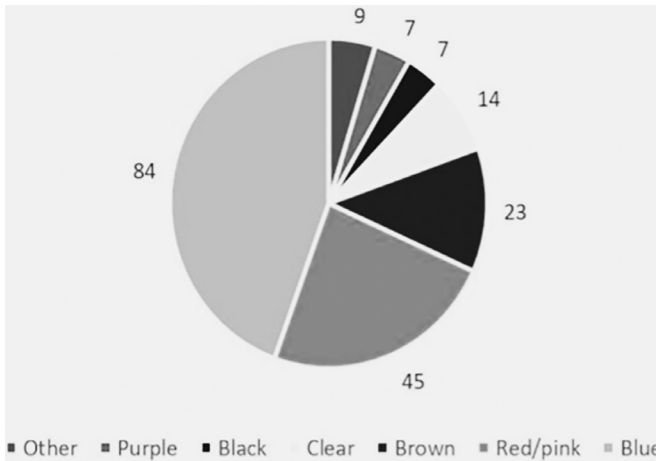

Figure 2.10 Beer particle colors. Color distribution of particles extracted from 12 brands of beer (Source: Kosuth *et al.*, 2018).

Allen *et al.* (2019) recently published an observation of atmospheric MP deposition in a remote, pristine mountain watershed French Pyrenees that is difficult for humans to access and far away from significant populations or industrial hubs. They found that the average MPs deposition found at this remote site was 365 ± 69 particles/m²/day, which was comparable to the average concentrations observed in Paris and Dongguan city if only fiber were included. Chen *et al.* (2020) found that MPs remained in the atmosphere and were transmitted over a long distance. Table 2.7 shows the summary of the afore-mentioned study findings.

- **Food packaging chemicals**

Recent research findings revealed that the ‘major source of human exposure to contaminants associated with plastic’ is chemical migration from food packaging into food and beverages. With acidic or alkaline foods and UV radiation or heat coming into contact with some plastic polymers, plastic degradation can occur and toxic monomers such as styrene are released. Plastic additives are a varied group of compounds that serve a variety of functions. Since they are not strongly bonded to the substance, these additives are another typical source of chemicals leaching into food. Chemical migration and leakage are further enhanced by non-intentionally added substances (NIAS) such as impurities, side products, and contaminants. To prevent food from spoiling, food packaging additives are intended to migrate out of the package for this purpose. According to a case study at Italian state schools where school meals were investigated (Cirillo *et al.*, 2011), plasticizers are easily absorbed by food and beverages. The packaging raised the average phthalate concentrations by more than 100%.

Table 2.7 Abundance of airborne MPs in some cities and regions.

Location	Average Concentration	Shape	Size, μm	Colors	Polymer Types	Reference
Paris	118 no./m ² /day	Fiber, fragment	100–5000	N/A	N/A	Dris <i>et al.</i> (2015, 2016, 2017)
Paris	110 \pm 96 no./m ² /day (urban) 53 \pm 38 no./m ² /day (sub-urban) 29% MPs	Fiber	50–5000	N/A	N/A	Dris <i>et al.</i> (2016)
Paris	5.4 no./m ³ (outdoor) 0.9 no./m ³ (indoor) 33% MPs	Fiber	50–3250	N/A	PA, PP	Dris <i>et al.</i> (2017)
Dongguan	36 \pm 7 no./m ² /day.	Fiber, fragment, film, foam	<00–4200	Blue, red, yellow, white, black	PE, PP, PS	Cai <i>et al.</i> (2017)
Yantai	400 no./m ² /day	Fiber, fragment, film, foam	50–3000	White, black, red, transparent	PET, PE, PVC, PS	Qian <i>et al.</i> (2017)
Shanghai	1.42 \pm 1.42 no./m ³	Fiber, fragment, granule	25–5000	Blue, black, red, transparent, brown, green, yellow, gray	PET, PE, PES, PAN, PAA, EVA, RY, EP, ALK	Liu <i>et al.</i> (2019a, 2019b, 2019c)
Hamburg	275 no./m ² /day	Fragment, fiber	65–5000	N/A	PE, EVAC, PTFE, PVA, PET	Klein and Fischer (2019)
Pyrenees	365 no./m ² /day	Fiber, fragment, film	50–2600	N/A	PS, PP, PE, PET	Allen <i>et al.</i> (2019)

- **Receptors of plastics in the environment and food chains**

In addition to sources and pathways, receptors are a significant aspect of consideration of the impact assessment models. Here, fauna and flora are regarded as receptors as well as consequences on the ecosystem and economy. Based on the sources and pathways, the receptor analysis shows the further consequences and implications and thus fills the data for a holistic view of MPs in the environment. In addition to the environmental impact, the extent to which the economy is affected, which is often neglected, also becomes clear.

2.2 FRAGMENTATION AND DEGRADATION OF PLASTIC LITTER

2.2.1 Definition of plastic fragmentation and degradation

One of the main reasons contributing to the occurrence of MPs in the environment is the extensive breakdown and fragmentation of plastics.

Weathering-related degradation results in a ‘progression of changes’ that includes loss in mechanical integrity, embrittlement, further degradation and fragmentation (Harshvardhan & Jha, 2013).

Fragmentation is most likely to occur at ‘advanced stages of degradation’ well beyond embrittlement for most plastics, mainly due to exposure to solar UV radiation (Andrady, 2011).

Biodegradation of plastic occurs at a very slow rate; for instance, a study revealed that only 1–1.7% decrease in mass was observed in laboratory-accelerated degradation of PE over a 30-day duration by microorganisms isolated from marine waters (Harshvardhan & Jha, 2013).

Complete degradation refers to the ‘destruction of the polymer chain and its complete conversion into small molecules’ such as carbon dioxide or methane (also called mineralization process). The process is distinct from degradation which refers to as **an alteration in the plastic’s properties** (e.g., embrittlement, discoloring) or its chemistry (Figure 2.11).

2.2.2 Influence of plastic fragmentation and degradation on its adverse effects

- **Size reduction**

Size reduction of many types of plastics ranging from macroplastics to small nanoplastics can occur in the environment under optimum conditions of degradation (photodegradation by UV, mechanical degradation, biodegradation, etc.). The reduced size contributes to the environmental distribution rate, and impacts on ecosystems and human health. Larger MPs (2–5 mm) may take longer to pass through organisms’ stomachs and may remain in the digestive system, potentially extending the exposure time resulting in a higher amount of toxins absorbed (Rochman, 2015). Plastics with a diameter of nanometers can easily penetrate through cell membranes and accumulate inside living cells (Gilliber *et al.*, 2019) (Figure 2.12).

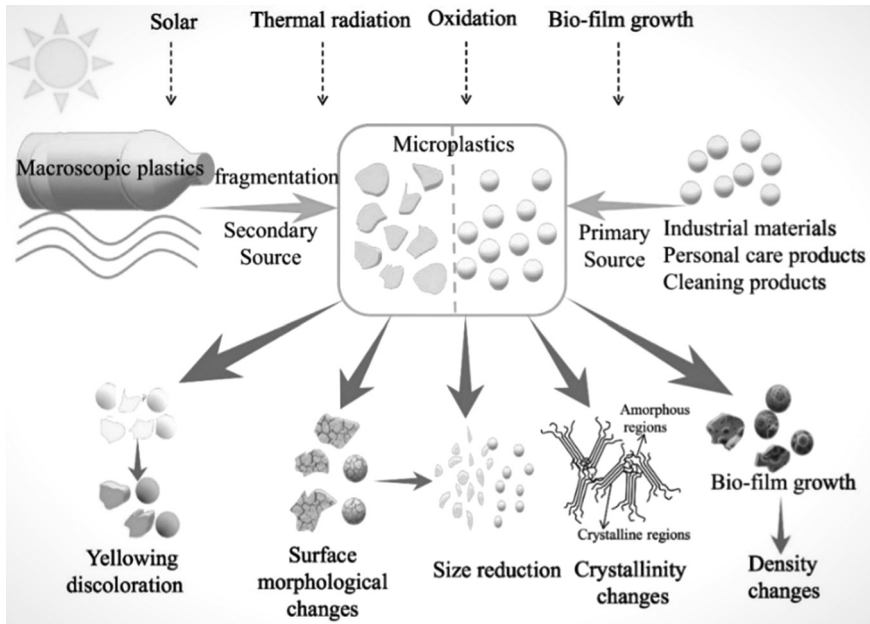

Figure 2.11 Property changes in plastic after degradation (Source: Guo et al., 2019).

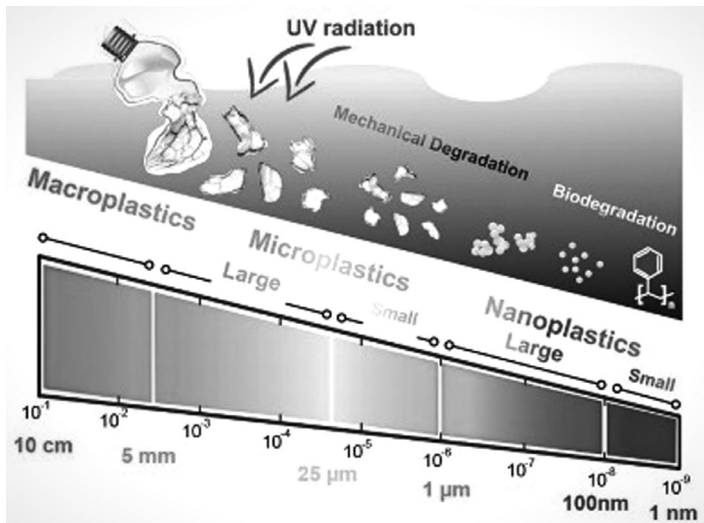

Figure 2.12 Degradation flow and size-based definition of plastics (Source: Gilliber et al., 2019).

- **Surface morphological change**

The increased specific surface area of MPs caused by fragmentation provides for better contact with water/sediment, resulting in faster chemical leaching or sorption rates and more space for biofouling. Degradation is defined as any change in the physical or chemical properties of a polymer caused by chemical, physicochemical (photodegradation, thermal degradation, mechanical degradation), or biological processes. Hydrolysis and oxidation are the most common polymer degradation mechanisms, which can be influenced by chemical or biological factors, some examples of which are the number of polymer branches, the molecular weight, the hydrophobicity/hydrophilicity ratio, the crystallinity, and the shape of the polymer. Based on the given factors, PVC is most susceptible to degradation, followed by HDPE and PE. (Figure 2.13) (Fotopoulou & Karapanagioti, 2015).

- **Surface area and porosity**

With the erosion of polymers, the specific surface area of plastics, mainly PET and PVC, increases. The pore volume of polymers is altered in numerous ways depending on their original condition, which results in different erosion processes and attributes after erosion. PET is more sensitive to biodegradation and the development of a biolayer that may interact with contaminants due to its increased specific surface area (Figure 2.14).

2.3 BIOACCUMULATION AND BIOMAGNIFICATION

2.3.1 Definition of bioaccumulation and biomagnification

Bioaccumulation refers to the accumulation and concentration of contaminants in organisms. Bioaccumulation is the sum of all absorption and loss processes, including respiratory and dietary intake and losses through egestion, passive diffusion, metabolism, transfer to offspring, and growth. As a result, bioaccumulation encompasses the more specialized bioconcentration and biomagnification processes (Figure 2.15). Bioconcentration is the process of chemicals being directly partitioned between water and the organism, resulting in higher concentrations in the latter. Biomagnification occurs when the feeder takes up contaminants in the diet, resulting in larger quantities in the feeder than in the diet. As a result of biomagnification, chemical concentrations rise along with trophic position in the food chain.

Direct uptake from water occurs through respiration, whereas indirect uptake occurs through food. Respiration, metabolism, egestion and growth dilution are examples of loss mechanisms. From the water to animals, bioaccumulating pollutants rise by more than 5000 times. As the total biomass per trophic level in the food chain declines (but the contaminants remain), contaminant concentrations rise as the food chain progresses (Borgå, 2013). MPs can reach the food chain and be transported between trophic levels, indicating bioaccumulation and biomagnification (Figure 2.16).

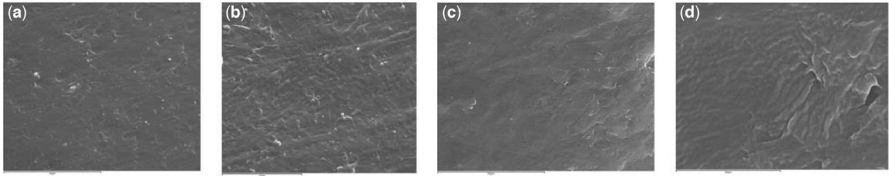

Figure 2.13 The surface topography of virgin plastic pellets from SEM for (a) high-density PE pellets enlarged 1000 times (note the gray scale bar at the bottom of the image; scale bar 60 μm), (b) high-density PE pellets enlarged 5000 times (scale bar 10 μm), (c) low-density PE pellets enlarged 1000 times (scale bar 60 μm), (d) low-density PE pellets enlarged 5000 times (scale bar 10 μm) (Source: Fotopoulou & Karapanagioti, 2012).

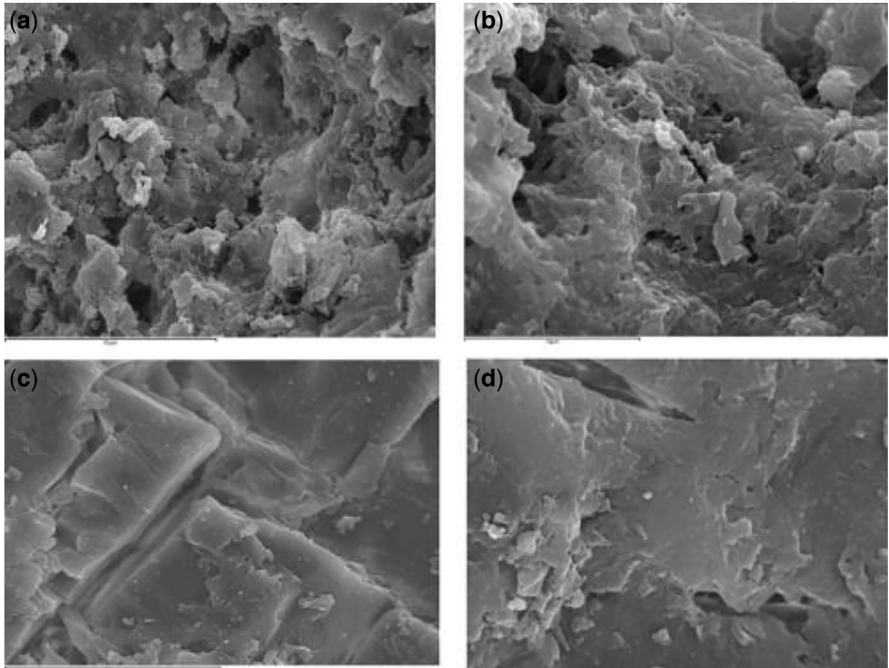

Figure 2.14 The surface topography of eroded plastic pellets from SEM for (a) PE pellets enlarged 1000 times (note the gray scale bar at the bottom of the image; scale bar 60 μm), (b) PE pellets enlarged 5000 times (scale bar 10 μm), (c) PP pellets enlarged 1000 times (scale bar 60 μm), (d) PP pellets enlarged 5000 times (scale bar 10 μm) (Source: Fotopoulou & Karapanagioti, 2012).

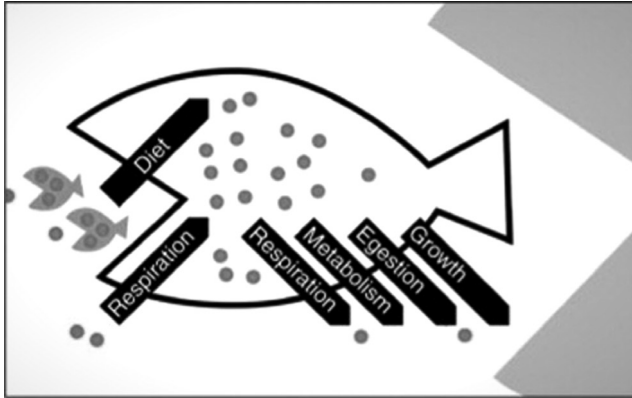

Figure 2.15 Bioaccumulation of contaminants (dots) to an organism (fish) as a net result of uptake and loss processes (arrows) (Source: Borgà, 2013).

2.3.2 Bioaccumulation of plastics in the food web

2.3.2.1 Bioaccumulation of plastic particles in environmental media and food webs

Plastic particles interact with marine organisms at all levels of the food chain in various ways. Bioaccumulation of plastic particles is a process that is based on an organism's ability to take plastic particles into its body through an exposure pathway. MP can be consumed directly or indirectly by organisms and remain in the body (e.g., on external appendages; Cole *et al.*, 2013) and/or be absorbed (i.e., taken up by the organisms into the body through cell membranes). MP absorption is observed in phytoplankton (Bhattacharya *et al.*, 2010; Long *et al.*, 2015). MPs can be taken up through the gills during the ventilation process, as seen in crabs (Watts *et al.*, 2014).

Over a hundred marine species have reportedly consumed MPs directly as food or accidentally capturing them while feeding and/or mistaking them for prey (Farrell & Nelson, 2013; Lusher, 2015).

Adverse physiological and biological effects of MPs have been reported in several invertebrates depending on the 'size of MPs,' with smaller sizes having more cellular impacts (Figure 2.17). Although it has been commonly reported that plastics are easily ingested and ejected in the micro-meter range, further research is necessary to confirm the contamination of more organisms and the effects of MP uptake and retention.

2.3.2.2 Amount and concentration of accumulated plastic particles in the food web through predation

Few studies have investigated the amount of MPs in tissues or blood fluid of organisms collected in the environment. Evidence for internal MP exposure is mainly limited to filter-feeding mussels and sediment-feeding polychetes, as seen in Table 2.8.

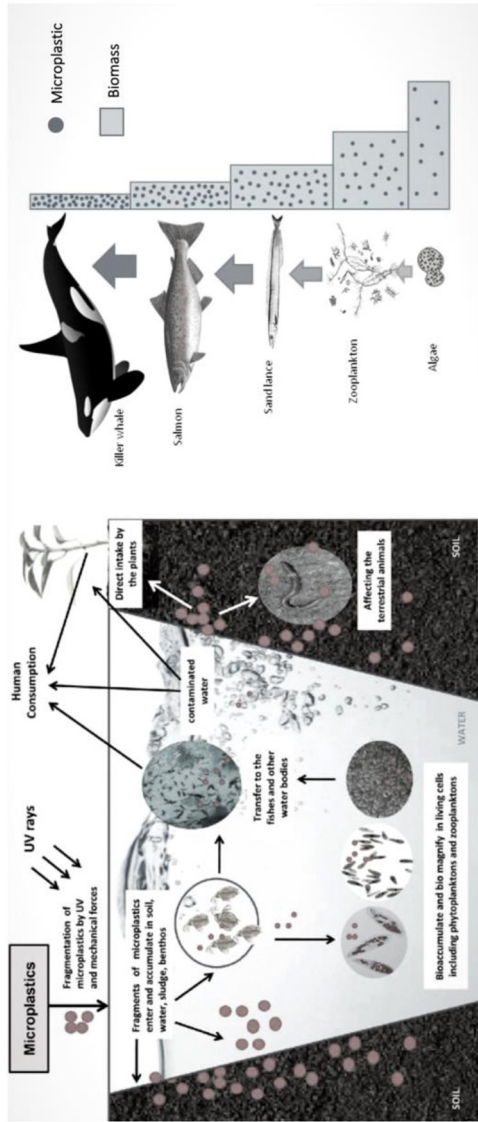

Figure 2.16 Possible bio-accumulation and bio-magnification of MP in our environment (Source: Adapted from Miraj et al., 2021).

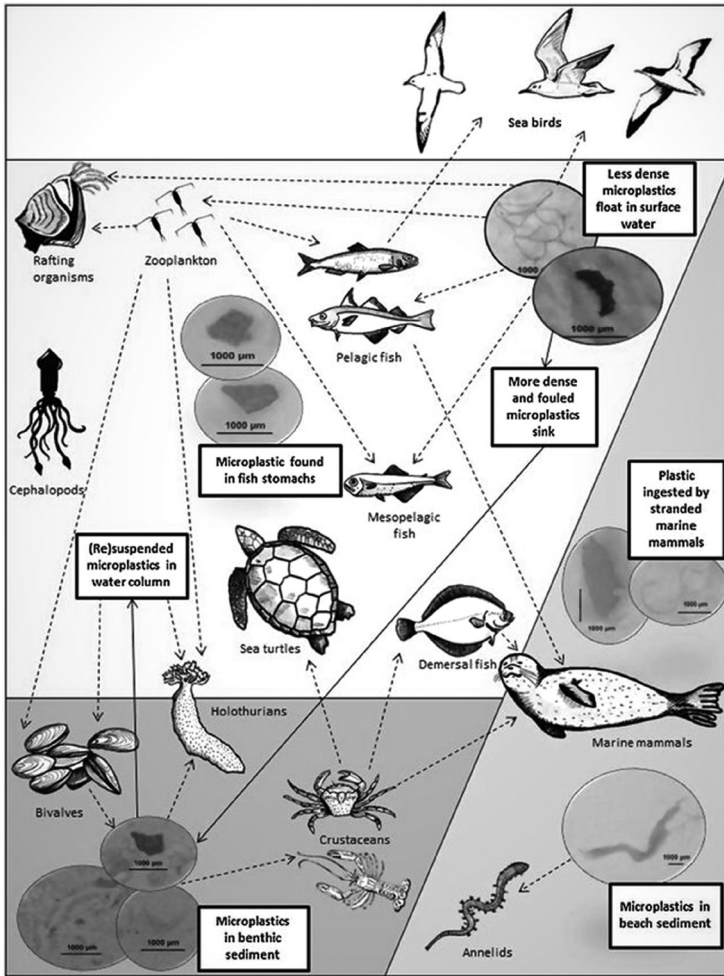







Figure 2.17 MP interactions with physical and biological matrices in the marine environment. Solid arrows represent environmental links (i.e., how MPs may transfer between sediment and water) and dashed arrows represent biological links (i.e., how MPs may transfer among trophic levels) (Source: Lusher, 2015).

2.3.2.3 Bioaccumulation of absorbed contaminants carried by plastic fractions (a case study of POPs)

Plastics, being hydrophobic, tend to ‘absorb hydrophobic persistent organic pollutants’ (POPs) such as polychlorinated biphenyls (PCBs) and polycyclic aromatic hydrocarbons (PAHs) while circulating in marine and other water bodies, resulting in increasing potential threats associated with accumulated pollutants.

Table 2.8 MP uptake and transition into tissues, cells and organelles of marine animals.

Species	Plastic Type and Size	Exposure Pathway	Accumulated Organelles	Average Concentration	References
 <i>Mytilus edulis</i>	Microscopic polystyrene particles (3 and 9.6 μm)	Ingestion	Accumulated in the gut, then translocated to the circulatory system within 3 days and were taken up by hemocytes	NA	Browne <i>et al.</i> (2008)
 Marine mussels (a species used for human consumption)			Accumulated in the gut, then moved from the gut to the circulatory system and was retained in the tissues	-4.5 ± 0.9 particles in their tissue $-5.1 \pm 1.1/100$ L of extracted hemolymph	Van Cauwenberghe <i>et al.</i> (2013)
 Lugworms			Accumulated in the gut and retained in the tissues	19.9 ± 4.1 particles in their tissue and coelomic fluid	
 Marine mussels	HDPE powder (>0–80 μm)	Ingestion	Intracellular uptake into the digestive tubules and accumulation inside of lysosomes coincides	NA	von Moos <i>et al.</i> (2012)
 Shore crab (<i>Carcinus maenas</i>)	Fluorescently labelled polystyrene microspheres (8–10 μm)	Inspiration across the gills	Retained within the body tissues of the crabs for up to 14 days following ingestion and up to 21 days following inspiration across the gill	NA	Watts <i>et al.</i> (2014)

POPs are a type of very toxic chemical pollution that has been identified as a severe global threat to human health and ecosystems. Because of their potential hazards, POPs are subject to limitations and bans under the Stockholm Convention on Persistent Organic Pollutants. Plastic additives (softeners and flame retardants) recognized by the international community as POPs include short-chain chlorinated paraffin (SCCPs), polybrominated diphenyl ethers (PBDEs), nonylphenols, octylphenols, and per- and polyfluoroalkyl substances (PFAS). Specifically, POPs are lipophilic and are absorbed in fatty tissues through the process of bioaccumulation. These POPs can remain intact for exceptionally long periods or many years with the half-life varying from days to years. In living organisms, including humans, POPs can be found at high concentrations and are linked to cancer, reproductive harm, or other diseases.

In water, accumulated contaminants can exhibit up to 100 times higher concentration compared to their background levels. When ingested, some of these compounds have been found to desorb into the tissues of marine organisms. MP ingestion is possibly a significant source of organic pollution exposure for aquatic species. Desorption rates can reach up to 30 times greater in the intestinal environment of warm-blooded species (38°C, pH 4) than in aquatic systems. As a result, MPs may be more relevant than previously considered in mammals, including humans. However, it is questionable how much plastic debris contaminated with accumulated pollutants contributes to the body burden (the total amount of hazardous chemicals in the body). Furthermore, environmental factors such as pH, temperature can affect the absorption–desorption rate and pathway of pollutants, which can be both MPs, the pollutants themselves and other substances absorbed on MPs, in organisms as shown in [Figure 2.18](#).

2.3.2.4 Amount and concentration of absorbed contaminants carried by plastic fractions (a case study of POPs)

The amount and concentration (C) of absorbed contaminants carried by plastic fractions to other phases/organisms can be determined by the following equation:

$$K = \frac{C_{\text{biota}}}{C_{\text{microplastic}}} \quad (2.1)$$

where K is partitioning coefficient, C_{biota} is the concentration of an absorbed contaminant in the organism/biota and $C_{\text{microplastic}}$ is the concentration of an absorbed contaminant on the MP surface.

As shown in [Figure 2.19](#), the levels of DDT accumulated in the tissues of living organisms proceed up the food chain from producers to consumers. The DDT quantity in the tissues of the heron at the base of the food chain is approximately 1 million times higher than the DDT concentration in the water ([Yu et al., 2019](#))

2.3.3 Biomagnification of plastic litter in the food web

2.3.3.1 Transfer of plastic particles to the food web

MP particles may be transferred through the food web as predators consume prey. As the producer and primary consumer, all 10 zooplankton taxa examined

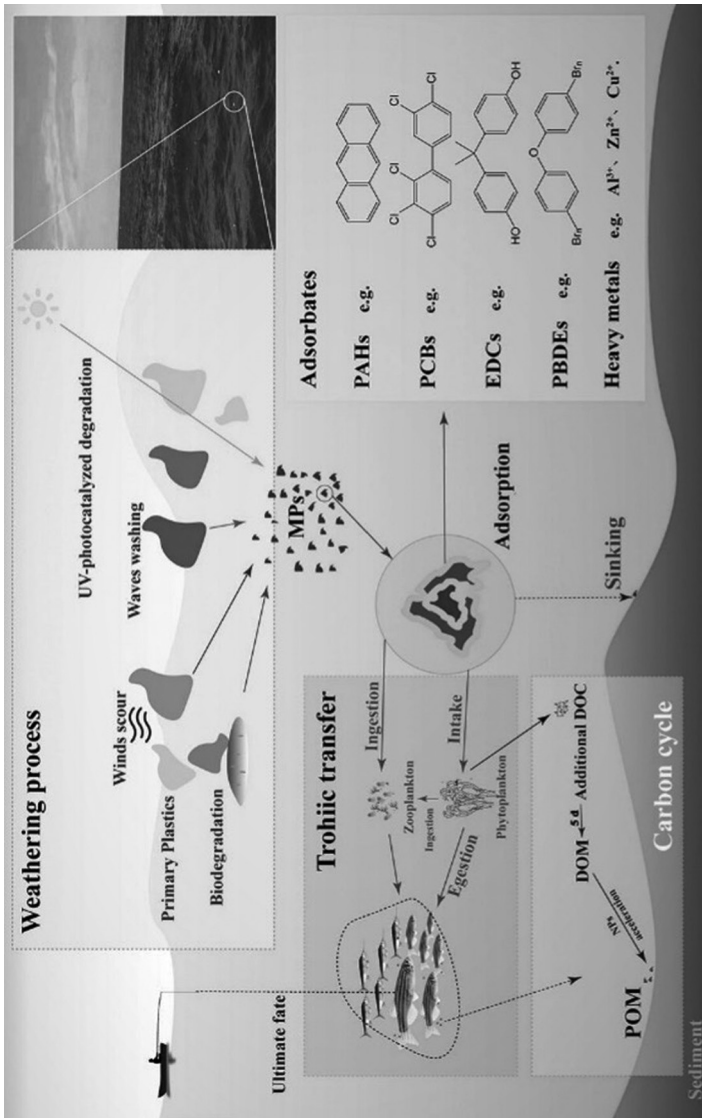

Figure 2.18 Effects of environmental factors on the properties and absorption behavior of MPs and normal contaminants (Source: Yu et al., 2019).

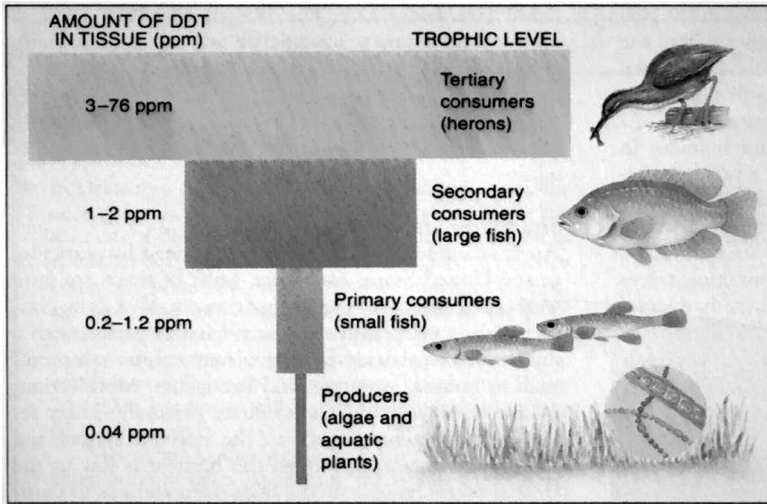

Figure 2.19 Level of DDT concentrates on the tissues of various organisms along the food chain from primary producers to top consumers (Source: Walsh *et al.*, 2008).

from the Baltic Sea ingested 10 μm polystyrene microspheres in a laboratory feeding experiment. Microparticles found in zooplankton were transferred after mysid shrimps consumed them, indicating that MPs can be spread along the food chain (Setälä *et al.*, 2014).

Consequently, at the upper level, the crabs (*Carcinus maens*) were fed mussels (*Mytilus edulus*) that had been exposed to 0.5 m polystyrene microspheres. As a result, MPs were found in crabs' stomachs, hepatopancreas, ovaries, and gills, with the highest concentration detected 24 hours after feeding. After 21 days, the crabs had excreted nearly all of the ingested MPs (Farrell & Nelson, 2013). In a similar study, Lusher *et al.* (2013) found MP particles in the gastrointestinal tracts (GITs) of 36% of 504 individual fish collected from the English Channel, confirming ingestion of MPs in prey species in the environment. Murray and Cowie (2011) also found MPs (mainly plastic strands) in the stomach contents of 62% of Norwegian lobsters (*Nephrops norvegicus*) collected from the Clyde Sea, and confirmed that plastic fibers remained in the GI tract of the lobsters.

2.3.3.2 Transfer of absorbed contaminants carried by plastic fractions (a case study of POPs)

POPs are widely present in the environment in all regions of the world. POPs can magnify up to 70 000 times the background level with high persistence ability and transmission rate. Organisms at the top of the food chain bear the greatest POPs concentration. Successive release over time results in the ubiquitous presence of POPs. A serious problem can occur when plastic particles absorb POPs, stay in the organism's cell, and desorb toxic substances over time. Moreover, POPs absorbed particles can transfer to the next generations during pregnancy and breastfeeding.

POPs can enter and contaminate fetuses of humans and other mammals before birth and can also be passed on to infants through breastmilk. POPs are extremely harmful to a developing fetus, causing health problems such as neurological diseases and deficits that last an entire life of a child. POPs are seriously harmful to infants, children, women, those who are malnutrition, and those who have a weakened immune system, such as the sick or elderly. Children due to their lower body weight or lower immune response are more susceptible to POPs than adults since they are exposed to higher amount of pollutants when compared to adults.

Example of transfer of absorbed contaminants carried by plastic fraction

In terms of the aquatic food chain;

$$y = 0.05 \left[\frac{\text{mg Biomass}}{\text{mg Substrate utilized}} \right]$$

Notice: 5% of biomass produced from consuming 1 mg of substrate utilized (Burian *et al.*, 2020).

To produce 1 kb of bird biomass, birds need to consume at least 8000 kg of phytoplankton

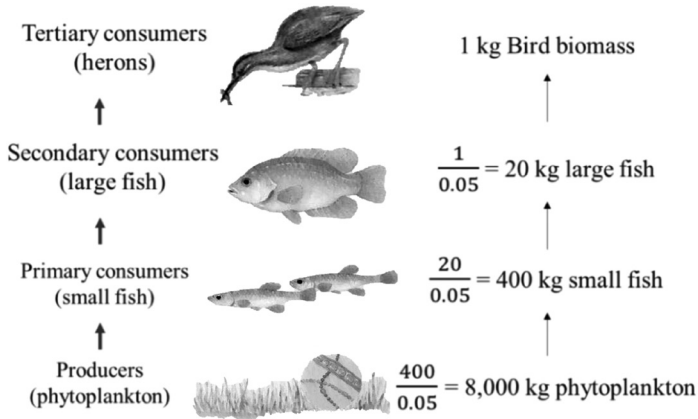

Question: To supply a certain biomass for human beings, how much phytoplankton should be produced? And if plastic particles accumulate in phytoplankton, how many plastic particles are transferred to a higher level in the food chain, like humans?

Example 1: Aquatic food chains include plankton, smelt, trout and birds. Assume yield coefficients at each level to be 0.15 and that 95% of the pollutant is transferred to the next level up the food chain. Assume that DDT has a plastic particle to plankton partition coefficient ($K_{pt/p}$) of 250 000 and 100% desorption into plankton cell. If the concentration of DDT in the plastic particle is 1.0 ppt, estimate DDT concentration at each level.

Solution 1:

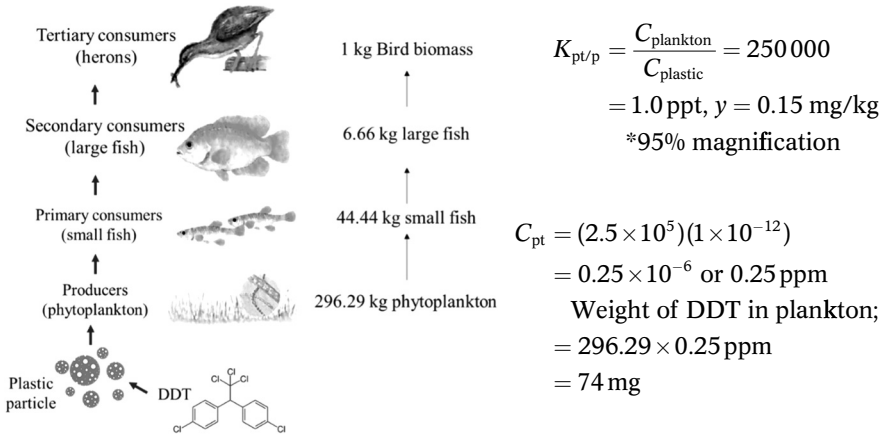

Organisms/ Predators	Accumulated Concentration of DDT	Accumulated Weight of DDT (mg)	Amount Transferred (mg)
Bird	$\frac{63.5 \text{ mg}}{1 \text{ kg}} = 63.5 \text{ ppm}$	$63.5 \text{ ppm} \times 1 \text{ kg} = 63.5$	60.3
Large fish	$\frac{66.8 \text{ mg}}{6.66 \text{ kg}} = 10.02 \text{ ppm}$	$10.02 \text{ ppm} \times 6.66 \text{ kg} = 66.8$	63.5
Small fish	$\frac{70.3 \text{ mg}}{44.44 \text{ kg}} = 1.58 \text{ ppm}$	$1.58 \text{ ppm} \times 44.44 \text{ kg} = 70.3$	66.8
Phytoplankton	0.25 ppm	74	70.3
Plastic particles	1.0 ppt		

Example 2: Hexachlorobenzene (HCB) is a plastic particle for plankton partition coefficient ($K_{pt/p}$) of 200 000; a plankton to smelt magnification factor of 7.5; and a smelt to lake trout magnification factor of 3.5. If the concentration of HCB in plastic particles is 1.0 ppt, will either fish exceed the fish consumption standards?:

- 5 ppm for general consumption
- 1 ppm for pregnant and nursing women

Solution 2:

$$K_{pt/p} = \frac{C_{\text{plankton}}}{C_{\text{plastic}}}; \quad C_{\text{plankton}} = [2 \times 10^5][1 \times 10^{-12}] = 0.2 \times 10^{-6} \text{ or } 0.2 \text{ ppm}$$

$$\frac{C_{\text{smelt}}}{C_{\text{plankton}}} = 7.5; \quad = 7.5 \times 0.2 = 1.5 \text{ ppm}$$

$$\frac{C_{\text{trout}}}{C_{\text{smelt}}} = 3.5; \quad = 3.5 \times 1.5 = 5.25 \text{ ppm}$$

Interpretation:

- Lake trout exceeds general consumption standards and both species exceed the standard for pregnant and nursing women.
- Both could easily argue based on uncertainty.

2.3.3.3 Lifetime and excretion pathway

The presence of MPs in organisms indicates recent exposure to these particles. MPs either accumulate or are excreted after being ingested into the body (hemolymph or tissues) depending on the size, shape, and composition of the particles. If MPs accumulate, chemical and/or physical effects are likely to occur and remain over time. If excreted, these side effects should be eradicated throughout the healing and repair phase. After a single particular exposure, MP concentrations in the hemolymph rise at a specific time (which varies by species, plastic type, and exposure time) and subsequently decrease in abundance (Browne *et al.*, 2008; Farrell & Nelson, 2013). The amount that is removed or transferred to other organ systems or tissues is unknown. According to a study of von Moos *et al.* (2012), the elimination of MPs from the digestive tubules after a period of 12–48 hours, and a shift of HDPE particles into the newly formed connective tissue (fibrosis) around the tubules, indicate a repair mechanism of injured tissue, as shown in a study in mussels after acute exposure to HDPE (0–80 μm size range) for 12 h followed by regeneration in plastic-free seawater. Similar studies with PVC MPs demonstrated particle retention in the stomach for up to 12 days, with smaller particles retaining longer than bigger particles.

2.4 ECOLOGICAL TOXICITY OF PLASTICS**2.4.1 Fundamentals of toxicology and the environment**

In conventional terms, toxicology can be defined as the scientific study of the effects of toxicants on biological systems, which can be humans, animals, and other living organisms. Toxicological research has significantly contributed to an understanding of the basic mechanisms on how contaminants and/or pollutants cause adverse effects and health impacts. More recently, toxicology has been considered as ‘the study of all the negative effects of chemicals and physical agents interacting with living organisms.’ (Costa & Teixeira, 2014).

A study of the effects of poisons revealed poisonous substances can be produced by plants (phytotoxins), animals (zootoxins), or bacteria (bacteriotoxins). The specific chemical substances produced and released by poisonous living organisms are defined as ‘toxicant’. On the other hand, an anthropogenic and/or man-made substance that is not normally found in the body is known as ‘xenobiotic’ (Gupta, 2020).

The amount of an agent or chemical offered to an animal, or a human, is referred to as a ‘dose’. In this context, a response refers to an observation or effect detected in an animal or a human during or after exposure to the agent. Exposure refers to an instance when an animal or a human comes into contact with or is exposed to an agent or chemical (dose). The concept of exposure is determined by the routes of exposure, the frequency of exposure, and the duration of exposure

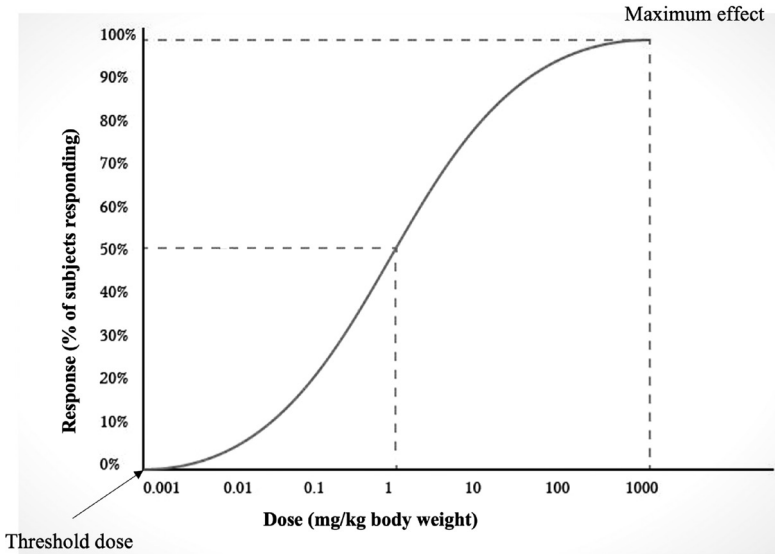

Figure 2.20 Dose–response relationship; threshold dose is the lowest dose at which a drug effect is seen, maximum effect is the maximum effect achievable by that dose (Source: adapted from Yartsev, 2015).

(acute vs. chronic) (WHO, 2019). However, routes of exposure can be classified into four pathways, including ingestion (water and food), absorption (through skin), injection (bite, puncture, or cut) and inhalation (air). The exposure route of greatest concern for humans is inhalation. Exposure to any substance in a specific concentration (dose) can cause a distinct response. The relationship is defined as ‘dose–response relationship’ (Figure 2.20). Exposure duration and frequency are also important factors in determining dosage. Acute exposure is defined as a single exposure lasting less than 24 hours. Repeated exposures are classified as: sub-acute – repeated for up to 30 days; sub-chronic – repeated for 30–90 days; and chronic repeated for over 90 days.

The fundamental premise of toxicology is an individual’s reaction to a dosage. The variety of responses among organisms that get the same dose of chemical is due to individual susceptibility. In all cases concerning chemicals, including those involving medicine and coffee, dose and individual susceptibility play a role. Individual susceptibility and variability, such as age, sex, individual variability, genetic variations, and species differences, distinguish a poison from a remedy.

2.4.2 Ecological toxicity and impacts of plastics

The effects of MPs exposure have been investigated at several levels of biological organization, ranging from the gene to the population level, providing a lot of information on organism interactions, exposure pathways, and biological consequences. However, most studies on the impact of MPs have focused on biological responses, and data on population and ecological levels is still

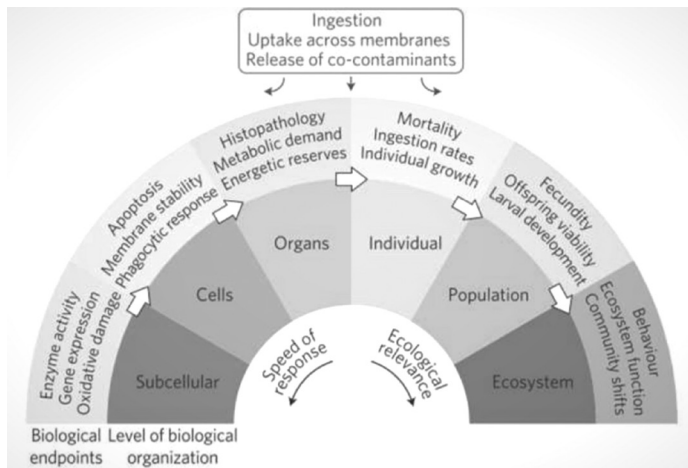

Figure 2.21 Schematic representation of impacts associated with MPs exposure across different levels of biological organization (Source: Ašmonaitė & Almroth, 2018).

limited. The adverse effects of direct MP exposure on organisms, including the consequences, are briefly described here. While particle characteristics (size, shape, polymer), chemical exposure (leachates or sorbed environmental contaminants), and exposure possibilities (exposure routes, concentrations, etc.) all have an impact on biological effects, the importance of aspects for mediating biological effects is also discussed in this report. MPs are ingested by fish, and their consumption can interfere with biological processes such as gastrointestinal function inhibition, as well as producing obstructions and causing feeding impairment (Figure 2.21).

2.4.3 Differential risk of marine litter interactions across the oceanic gradient

Aquatic population that live in environments where hydrographic patterns such as coastal systems or mesoscale oceans combine food and floating plastics (Pichel *et al.*, 2007). Surprisingly, one of the first field observations of this occurrence occurred from the Humboldt Current System (HCS) off Chile's central coast, where Bourne and Clark (1984) saw planktivorous seabirds feeding on a coastal front that also had a substantial concentration of floating plastics.

Even though floating trash volumes are lower than those in the fresh waters, these interactions are prevalent in the productive upwelling systems of the eastern boundary currents (for a summary, see Scales *et al.*, 2014) and present a massive risk to marine vertebrates.

Marine productivity is low in the ocean, particularly in the oligotrophic subtropical zones, and is often concentrated above seamounts or around marine habitats. Some species are at high risk of harmful interactions with floating plastics if these islands are within the area of the subtropical gyres' trash accumulation zones (Figure 2.22).



Figure 2.22 Conceptual model of (A) ingestion and (B) entanglement by marine vertebrates with anthropogenic marine plastics, highlighting the litter sources and abiotic processes (upper part of figures) and the interactions with marine invertebrates (bottom part of figures) (Source: Thiel *et al.*, 2018).

2.4.4 Toxicity of plastic and carried substance in aquatic life

MPs have been detected in the intestines of benthic invertebrates, fish, and larger mammals at various trophic levels, and the ingested MPs are transferred along the food chain, causing concerns about the threat to aquatic biota. MP particles that have dispersed in aquatic, terrestrial, and atmospheric ecosystems have a high bioavailability for various species, resulting in higher ecological toxicity than macroplastics. As a result of interference with fecundity, mortality and the dosage–effect relationship with physiological stress, including behavioral alterations, immune responses, abnormal metabolism, and changes in energy budgets, both direct and indirect evidence for the adverse effects of MPs have been found.

2.4.4.1 Heterogeneity of physicochemical properties

MPs' physicochemical properties are employed as the core information in toxicological investigations.

2.4.4.2 Physical properties

Bioavailability, a significant indicator of MPs' potential impact on various species, is determined by the pollutant's characteristics and the organisms' foraging habits. Unlike most selective foragers, species with general feeding patterns and prey capture mechanisms (e.g., predators that simply identify food from other objects based on a few criteria) are more likely to consume MPs that look like their normal prey (Peters *et al.*, 2017).

Physical properties influence the morphology and mobility of MPs in the aquatic environment, affecting bioavailability by modifying dispersion throughout the aquatic environment, resembling natural substances and causing different levels of physical damage to organisms. The size, color, density, and shape of MPs are the most explored physical properties, and each contributes differently to the serious implications.

- **Particle size**

MPs are about the same size as sand grains, microalgae and plankton, and are consumed by a variety of aquatic species, particularly nonselective foragers (Baldwin, 1995). Kpkalj *et al.* (2018) found that the rate of MP uptake by *Daphnia magna* is proportional to particle size, and the number of daphnids having MPs in their guts falls as the average particle size increases. The most common size of MPs consumed by daphnids was less than 100 μm , which corresponds to its size preference for food. Fernández (2001) revealed that *Artemia franciscana*, due to its smaller food feeding preferences (50 μm) than daphnids, on the other hand, consumed fewer MP particles under the same MP exposure settings. Ory *et al.* (2017) found that most ingested MPs by the amberstripe scud *Decapтерus muroadsi* (Carangidae) fish are typically 1.3–0.1 mm in size, similar to their prey. Resulting from consumption, particle size is an important factor in influencing the ability of MPs to translocate throughout an organism's body. Browne *et al.* (2008) found that the smaller MPs (3.0 μm) translocate more easily and readily within *Mytilus edulis* than the bigger particles (9.6 μm).

- **Particle shape**

Another important property in determining the interaction of polymeric particles with biological systems is the shape of particles (Wright *et al.*, 2013). Particles with a more irregular or needle-like shape may attach more readily to internal and external surfaces and have a greater effect in both cases. To illustrate this, Au *et al.* (2015) examined the impact of particle shape on the amphipod *Hyalella azteca* and found that polypropylene (PP) fibers were more hazardous than PP beads, illustrated in Table 2.9. Hua *et al.* (2014) also found that when zebrafish embryos were tested for mortality and hatching inhibition, zinc oxide nano-sticks caused more toxicity than nanospheres. Several relevant research or investigation studies on the particle toxicology and its impact (Besseling *et al.*, 2014; Farrell & Nelson, 2013; Lee *et al.*, 2013; Rosenkranz *et al.*, 2009; Setälä *et al.*, 2014) are summarised in Table 2.9.

- **Surface area**

The surface area is a significant characteristic since it increases as particle size decreases; hence, nanoscale particles can have greater effects. Although the surface area is not commonly reported in MPs research, it can be determined for primary micro-beads using spherical equivalent diameter, but this can result in an overestimation for irregularly shaped secondary MPs. For example, La Rocca *et al.* (2015) discovered that using geometrical estimates to estimate the surface area of nanoscale soot particles can result in a sevenfold overestimation of the surface area, requiring the application of a particle shape factor for adjustment.

- **Polymer crystallinity**

Because the crystalline region includes more ordered and strongly structured polymer chains, crystallinity is an important polymer characteristic. Physical properties such as density and permeability are changed, which affect hydration and swelling behaviour. Environmental MPs' crystallinity will change over time as they degrade. As the MP reduces in size, preferential breakdown in the amorphous portion of the polymer causes the overall crystallinity to rise (Gopferich, 1996). Crystallites will form as a result, and their toxicity may differ from that of the original MPs. Changes in crystallinity will affect the physical (surface area, particle shape, particle size, and density) and chemical (leaching of additives, adsorption of contaminants) aspects of environmental MPs, influencing ingestion rates and effect outcomes.

2.4.4.3 Chemical properties

- **Polymer types and additives**

Leaching of chemicals such as residual monomers, starting ingredients, solvents, catalysts, and additives (e.g., antioxidants, colors, biocides, plasticizers) introduced during compounding and processing can induce plastic-related toxicity (Andrady, 2015). Several monomers and additives used in the manufacturing of different plastic types have well-known toxicity

Table 2.9 Toxicity of different MP sizes, particle types and observed responses.

Organism	Particle Type	Main Findings	Reference
<i>Hyallela azteca</i>	Polyethylene MPs (powder; size: 10 and 27 μm) Polypropylene fibers (secondary; length 20–75 μm ; dia. 20 μm) Polystyrene microspheres Size: 0.05, 0.5, and 6 μm	Fibers were found to be more toxic than particles with 10-d LC ₅₀ of 71.43 fibers/ mL compared to 4.64 \times 10 ⁴ particles/mL. 6 μm beads did not affect the survival over two generations, 0.05 and 0.5 μm beads caused increased toxicity and impacts on survival and development in the F ₁ generation at 9.1 \times 10 ¹¹ and 9.1 \times 10 ⁸ /mL Demonstrated ingestion of both bead sizes, but the 20 nm beads were retained to a greater degree within the organism Reduction in body size and lower reproduction at concentrations \geq 30 mg/L (using a nominal density of 1.05 g/cm ³ this equals 74.3 billion particles/L) Potential of transfer from meso- to macro- zooplankton at concentrations of 1000, 2000, and 10 000 particles/ mL The number of MP in the haemolymph of the crabs was highest at 24 h (15 033/mL), and was almost gone after 21 days (267/mL).	Au <i>et al.</i> (2015)
<i>Tigriopus japonicus</i>			Lee <i>et al.</i> (2013)
<i>Daphnia magna</i>	Polystyrene carboxylated microspheres Size: 0.02 and 1 μm		Rosenkranz <i>et al.</i> (2009)
<i>Daphnia magna</i>	Polystyrene microspheres Size: 70 nm		Besseling <i>et al.</i> (2014)
<i>Eurytemora affinis</i> <i>Neomysis integer</i>	Polystyrene microspheres Size: 10 μm		Setälä <i>et al.</i> (2014)
<i>Mytilus edulis</i> <i>Carcinus maenas</i>	Polystyrene microspheres Size: 0.5 μm		Farrell and Nelson (2013)
Zebrafish embryos (<i>Danio rerio</i>)	Uncoated zinc oxide nanospheres (43 nm), nanosticks (150 nm), and cuboidal particles (900 nm)	Zinc oxide nanosticks induced higher toxicity than nanospheres and cuboidal particles for mortality and hatching inhibition endpoints.	Hua <i>et al.</i> (2014)

characteristics. Depending on how a chemical is compounded within a polymer matrix, the environmental release of additives from plastic materials and other plastic-associated chemicals can occur at any stage of the lifetime (Lambert *et al.*, 2014). Low molecular weight additives, for example, are only weakly entrenched in the polymer matrix and move quickly. Flame retardants from television housings and other electronic items (Deng *et al.*, 2007; Kim *et al.*, 2006), lead from unplasticized PVC pipes (Al-Malack, 2001), nonylphenol from food contact materials (Fernandes *et al.*, 2008), extractable PET cyclic and linear oligomers from bottles and food trays (Kim & Lee, 2012), and antimony leaching from PET water bottles are just a few additives released from consumer electronics (Keresztes *et al.*, 2009; Shotyky & Krachler, 2007; Westerhoff *et al.*, 2008). Overall, physical parameters such as the pore width of a polymer structure and the molecular size of the monomer and additives used will affect the rates at which residue monomers and additives leach (Gopferich, 1996). The relevance of leachable chemicals in terms of MP hazard potential is defined by their concentration in the parent material, partitioning coefficient, and the age and degree of degradation of a specific MP. For example, an older MP may have a higher degree of crystallinity, which means less leaching.

- **Surface chemistry**

The surface chemistry of environmental MPs will also change as they age. The plastic surface will be affected by photo and oxidative degradation processes that create new functional groups through interactions with OH radicals, oxygen, nitrogen oxides, and other photo produced radicals (Chandra & Rustgi, 1998). An increase in chemical reactions causes a plastic's surface to crack, exposing new surfaces to additional degrading processes (Lambert *et al.*, 2013). These processes may weaken the plastic surface, causing more microscopic particles to be released upon ingestion, increase chemical leaching, and increase gut retention times by forming more angular-shaped particles, distinguishing environmental MPs from primary micro-beads. However, it is unknown if these changes in surface chemistry are important determinants of toxicity in realistic exposure scenarios in the environment (Figure 2.23).

2.4.5 Ecotoxicological assessment of MPs

There are a variety of creatures that can be utilized in MPs ecotoxicological assessments; nevertheless, marine (micro)organisms were used in almost 75% of the research. Fish, mollusks, small and big crustaceans, annelids, mammals and echinoderms, birds and cnidarians, sponges, reptiles, and rotifers are commonly used as testing species. Small crustaceans predominate among creatures evaluated in a laboratory, but fish are commonly utilized in in-situ studies. Spherical particles, threads, and pieces are the most researched MPs shapes. Although PE and PS are the most studied MPs (because of their widespread prevalence in aquatic environments), ecotoxicological effects of other MPs such as PP, PES/PET, PVC, polyamide, acrylic, polyether, cellophane, and polyurethane have also been investigated. Small crustaceans predominate among creatures evaluated in a laboratory, but fish is commonly utilized in in-situ studies (Figure 2.24).

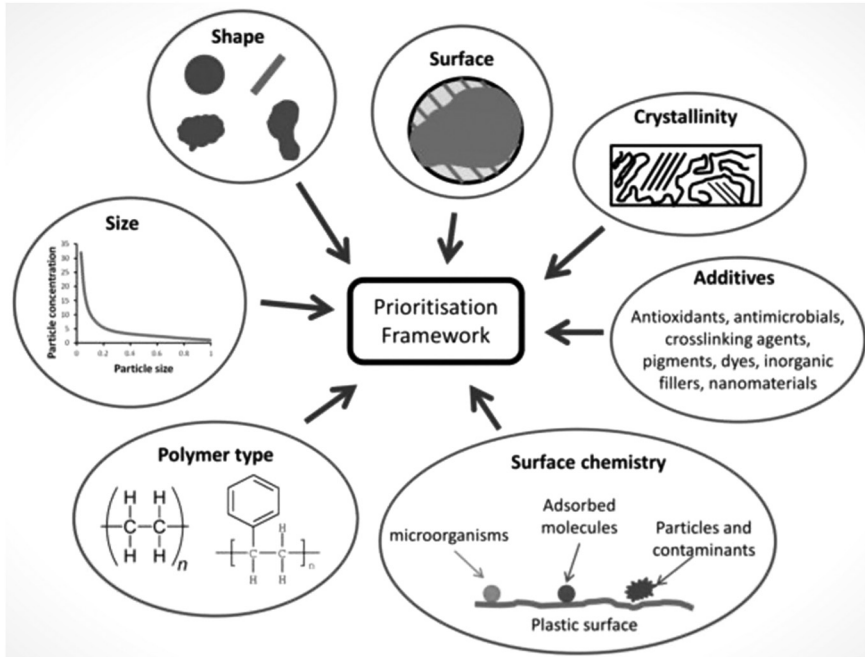

Figure 2.23 Different MP physical and chemical properties to be considered in a prioritization framework (Source: Lambert et al., 2017).

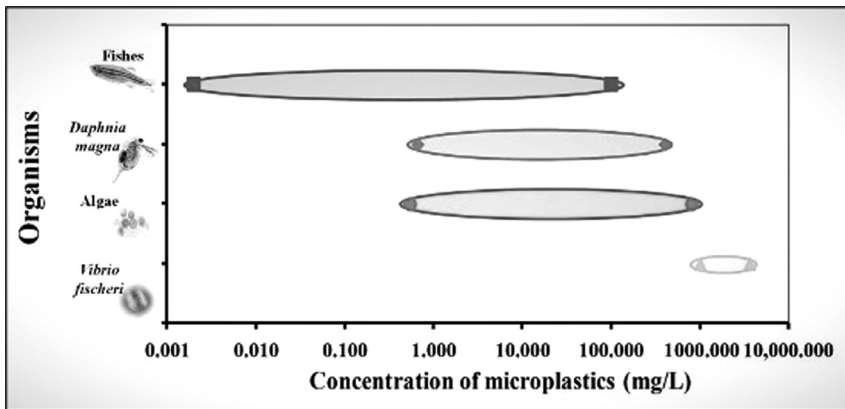

Figure 2.24 Range of ecotoxicological concentrations for different organism levels (Source: Miloloža et al., 2021).

2.5 EFFECTS OF MPS ON HUMAN HEALTH

The rise in plastic production, use, and consumption has raised concerns about the potential impacts on human health and environment since at least the 1970s and with growing frequency and urgency over the last two decades. For most of this period, attention has focused on human health exposures to specific plastic precursors or additives, and among specific populations, for example, workers exposed to benzene, infants exposed to phthalates and other plastic additives, or consumers exposed to bisphenol A in food packaging. To date, discussion of plastic's health and environmental impacts has usually focused on specific moments in the plastic life cycle: during use and after disposal. However, the lifecycle of plastics and their related human health impacts extend far beyond these two stages in both directions: upstream, during feedstock extraction, transport, and manufacturing, and downstream, when plastics reach the environment and degrade into micro- and nano-plastics.

Although it is generally believed that plastic polymers are lethargic and of little concern to public health, different types of additives and the residual monomers possibly retained from these polymers are responsible for the suspected health risks. Most of the additives present in plastics are potential carcinogens and endocrine disruptors. Ingestion, skin contact and inhalation are the main routes of exposure of humans to these additives. Dermatitis has been reported from skin contact with some of the additives present in plastics. MPs are major contaminants that can bioaccumulate in the food chain after ingestion by a wide range of freshwater and marine life, leading to public health risks. Human consumption of animals exposed to MPs and plastic additives can be detrimental. Biomonitoring studies on human tissues have shown that plastic constituents persist in the human population by measuring environmental contaminants.

2.5.1 Plastic litter exposure pathways

Human exposure to specific plastic precursors or additives has potential impacts on health along the plastic life cycle, especially plastic waste management processes and plastics in the environment. Once plastics reach the environment in the form of macro- or MPs, they slowly fragment into smaller particles and contaminate all areas of the environment (air, water, and soil), accumulate in food chains, and release toxic additives or concentrate additional toxic chemicals in the environment, making them bioavailable again for direct or indirect human exposure. To fully assess the health impacts of our global dependence on plastic, one must therefore consider each stage of this life cycle and all possible exposure pathways of the variety of substances used and released throughout the life cycle (Figure 2.25). Impacts of any substance on human health will vary depending on the specific route of exposure to the substance: **inhalation** – what we breathe, **ingestion** – what we eat and drink, and **skin contact** – what we touch or encounter topically.

2.5.2 Public health effects of plastic additives

Different additives are used in the production of plastics and have been reported to have various detrimental effects on humans. Table 2.10 shows the different

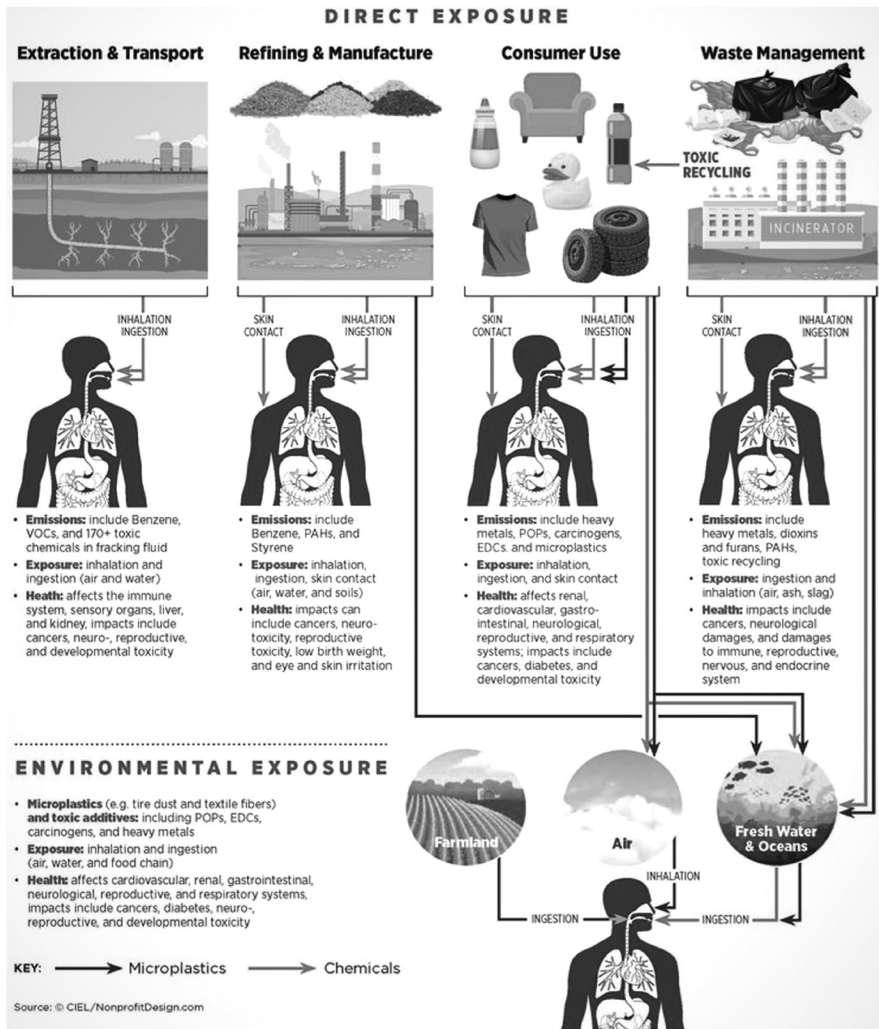

Figure 2.25 Human exposure to a large variety of toxic chemicals and MPs through inhalation, ingestion, and direct skin contact, all along the plastic lifecycle (Source: Azoulay et al., 2019).

types of additives used in plastic production, their effects and the types of plastics.

2.5.3 Toxicity of MPs

Fiber and human health studies among nylon flock workers suggested there was no evidence of increased cancer risk, although workers had a higher

Table 2.10 Different additives used in plastic production, their effects and the plastic types.

Toxic Additives	Uses	Public Health Effect	Plastic Types
Bisphenol A	Plasticizers, can liner	Mimics estrogen, ovarian disorder	Polyvinyl chloride (PVC), polycarbonate (PC)
Phthalates	Plasticizers, artificial fragrances	Interference with testosterone, sperm motility	Polystyrene (PS), polyvinyl chloride (PVC)
Persistent organic pollutants (POPs)	Pesticides, flame retardants, and so on	Possible neurological and reproductive damage	All plastics
Dioxins	Formed during low temperature combustion of PVC	Carcinogen, interferes with testosterone	All plastics
PAHs	Used in making pesticides	Developmental and reproductive toxicity	All plastics
PCBs	Dielectrics in electrical equipment	Interferes with thyroid hormone	All plastics
Styrene monomer	Breakdown product	Carcinogen, can form DNA adducts	Polystyrene
Nonylphenol	Anti-static, anti-fog, surfactant (in detergents)	Mimics estrogen	PVC

Source: Alabi et al. (2019).

prevalence of respiratory irritation. Interstitial lung disease, a work-related condition that induces coughing, dyspnea (breathlessness), and reduced lung capacity, has been identified in 4% of workers from nylon flock plants in the US and Canada. Workers processing para-aramid, polyester, and PA fibers in the Netherlands presented similar symptoms, including coughing, dyspnea, wheezing, and increased phlegm production. Prick tests and nasal and inhalation provocation tests in nylon workers also found synthetic fibers, such as nylon, may act as haptens, causing an allergic reaction leading to occupational asthma. Histopathological analysis of lung biopsies from workers in the textile (nylon, polyester, polyolefin, and acrylic) industry showed interstitial fibrosis and foreign-body-containing granulomatous lesions postulated to be acrylic, polyester, and/or nylon dust. The clinical symptoms presented were similar to allergic alveolitis (a form of inflammation in the lung). Although occupational exposure likely occurs at levels higher than those in the environment, health outcomes are evidence of the potential for MPs to trigger localized biological responses, given their uptake and persistence.

Both cellulosic and plastic microfibers have been observed in non-neoplastic and malignant lung tissues taken from patients with different types of lung cancer. The fibers exhibited little deterioration, supporting the notion that they are persistent.

Additionally, these observations suggest that the human airway is of a sufficient size for plastic fibers to penetrate the deep lung; one fiber found was 135 μm in length, approximately one-quarter of the diameter of a respiratory bronchiole of generation 17 (540 μm diameter, 1410 μm length). These observations confirm that some fibers avoid clearance mechanisms and, as they persist, these foreign bodies may induce acute or chronic inflammation. In addition to persistence, fiber dimensions play a role in toxicity. Thinner fibers are respirable, whereas longer fibers are more persistent and toxic to pulmonary cells; fibers of 15–20 μm cannot be efficiently cleared from the lung by alveolar macrophages and the mucociliary escalator fibers of 10 μm in length are mostly carcinogenic.

2.5.4 Potential for and factors that may affect bioaccumulation

An essential factor determining whether MPs present a physical threat or act as a vector for chemical transfer is the ability of these particles to accumulate. Throughout evolution, both the lungs and GIT have likely been exposed to non-degradable, exogenous nano and microparticles, and endogenous nanoparticles. Recently, there has been an increased dietary influx of non-degradable microparticles, approximately 40 mg/person/day, primarily due to their inclusion as additives in processed foods. The contribution of MPs to exogenous microparticle exposure is unknown, however, the biological response to MPs in comparison to other non-degradable microparticles could differ due to their unique chemical composition and properties. MPs are resistant to chemical degradation *in vivo*. If inhaled or ingested, they may also resist mechanical clearance, becoming lodged or embedded. Their bio-persistence is an essential factor contributing to their risk, along with their use. The findings suggested nano- and microparticles could translocate across living cells to the lymphatic and/or circulatory system, potentially accumulating in secondary organs, or impacting the immune system and health of cells. Retention time, and therefore the likelihood of uptake and clearance, is influenced by particle characteristics such as size, shape, solubility, and surface chemistry; by biological factors such as the anatomical site of deposition and structure; and by the nature of particle interaction with different biological structures, including the air–liquid interface, aqueous phase, and free cells (e.g., macrophages, dendritic cells, epithelial cells). Uptake of inhaled MPs will depend on their wettability; it is possible that inhaled MPs deposited in the airway will not be immersed in the lung-lining fluid due to their hydrophobicity and may therefore be subjected to mucociliary clearance leading to exposure via the gut (Figure 2.26a). The shape also affects displacement at the air–liquid interface; shapes with sharper edges are less likely to be displaced in liquid. However, the histological prevalence of plastic microfibers in flock workers and lung cancer tissue biopsies implies that uptake and embedment of at least plastic microfibers are possible. As with lining fluid of lungs, mucus is the first layer in the GIT that foreign particles interact with. Here, mucus can cause particles to aggregate; surfactants reduce mucus viscosity, increasing the uptake of particles.

Size and surface charge also influence the ability of MPs to cross the GIT mucus gel layer and contact the underlying epithelial cells; smaller sizes and negative surface charge are most likely to lead to increased uptake. If a MP

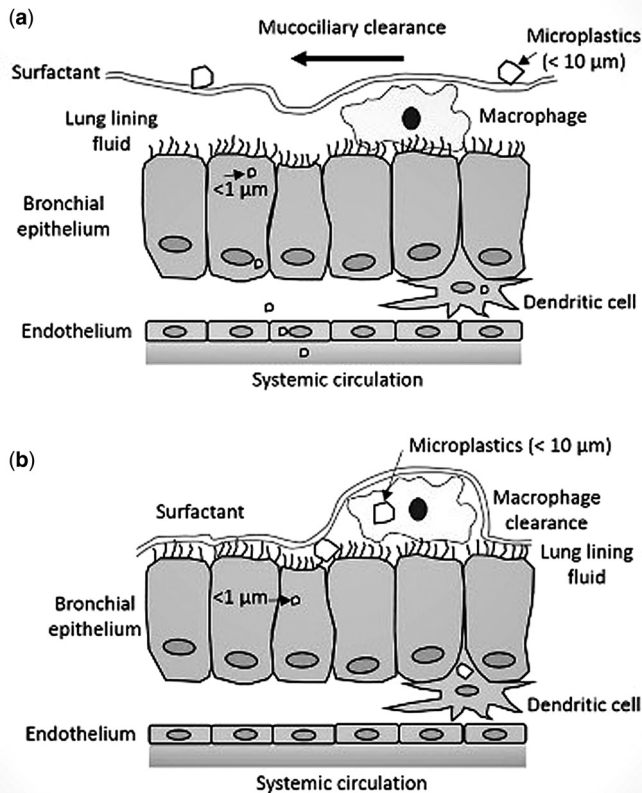

Figure 2.26 Potential MP ($0.1 > 10 \mu\text{m}$) uptake and clearance mechanisms in the lung. (a) The chance of MP displacement by the lung-lining fluid (surfactant and mucus) is reduced in the upper airway, where the lining is thick (central lung). Here, mucociliary clearance is likely for particles $>1 \mu\text{m}$. For particles $<1 \mu\text{m}$, uptake across the epithelium is possible. (b) If the aerodynamic diameter of a MP permits deposition deeper in the lung, it may penetrate the thinner lung-lining fluid and contact the epithelium, translocating via diffusion or active cellular uptake (Source: Wright & Kelly, 2017).

contacts the airway or gastrointestinal epithelium, there are several routes of uptake and translocation that may occur. This is primarily via endocytic pathways in the lung and GIT, and also via perception in the GIT. Paracellular transfer of nanoparticles through the tight junctions of the epithelium has been postulated for the GIT. Although tight junctions are extremely efficient at preventing such permeation, their integrity can be affected, potentially allowing for particles to pass-through (Figure 2.27).

2.5.5 Toxicity of MP particles to cells and tissues

Compared to chemicals used in plastic, less is known about the toxic effects of plastic particles in the human body. A recent review of potential health

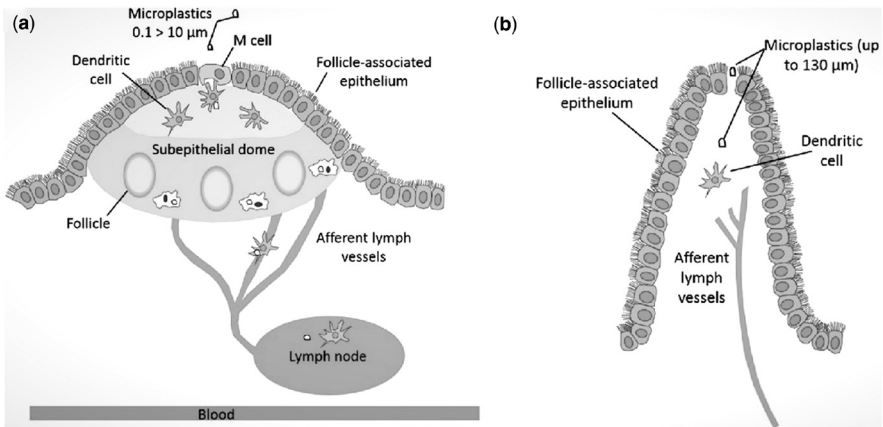

Figure 2.27 Predicted pathways of MP uptake from the GIT. (a) MP ($0.1 > 10 \mu\text{m}$) uptake from the GIT lumen via endocytosis by the M cells of the Peyer's patches. M cells sample and transport particles from the intestinal lumen to the mucosal lymphoid tissues. (b) MP uptake from the GIT lumen via paracellular perception. Nondegradable particles, such as MPs, may be mechanically kneaded through loose junctions in the single-cell epithelial layer into the tissue below. Dendritic cells can phagocytose such particles, transporting them to the underlying lymphatic vessels and veins. Distribution of secondary tissues, including the liver, muscles and brain, could occur (Source: [Wright & Kelly, 2017](#)).

risks of MP particles listed concerns that MP entering the human body could lead to inflammation (linked to cancer, heart disease, inflammatory bowel disease and rheumatoid arthritis among others), genotoxicity (damage to the genetic information within a cell causing mutations, which may lead to cancer), oxidative stress (leading to many chronic diseases such as atherosclerosis, cancer, diabetes, rheumatoid arthritis, post-ischemic perfusion injury, myocardial infarction, cardiovascular diseases, chronic inflammation and stroke), apoptosis (cell death associated with a wide variety of diseases including cancer), and necrosis (cell death associated with cancer, autoimmune conditions, and neurodegeneration). Over time, these effects could also lead to tissue damage, fibrosis and cancer.

All plastic contains reactive oxygen species (ROS), or free radicals, which are unstable molecules that contain oxygen and easily react with other molecules in a cell. A build-up of free radicals in cells may cause damage to DNA, RNA and proteins, and can lead to cell death. Inflammation appears to be the main response to micro- and nanoplastics entering the GIT or the pulmonary system. The effects of plastic particles released into the body from degraded plastic prosthetic implants indicate that inflammation is a notable outcome of plastic particles crossing the respiratory or GIT epithelium. PE and PET particles move around the body, travelling through the lymph system and to the liver and spleen. PE wear particles accumulate in the lymph nodes, surrounding joint replacements that completely replace the lymph nodes, resulting in severe

inflammation. Similar reactions can occur by ingesting or inhaling MPs if they can cross the epithelia.

2.5.6 Human health effects of plastic additives (consumer use)

Whether plastic is only used once (such as a polystyrene coffee cup) or is used for years (such as casing around a television), plastic use in consumer goods can negatively impact human health. Mass-produced plastics entered the global market after World War II. A recent analysis of all plastics ever made estimates that 8300 million metric tons of virgin plastics have been produced through the end of 2015. That analysis breaks plastics into three categories: polymer resins, synthetic fibers, and plastic additives. The most prevalent plastic resins are manufactured from polyethylene (PE), polypropylene (PP), polystyrene (PS), polyvinylchloride (PVC), polyethylene terephthalate (PET) and polyurethane (PUR) resins. The most common plastic fibers come in the form of polyester, polyamide and acrylic (PP&A). As a result of the global shift from reusable to single-use packaging (including containers), the most significant market for plastics today is packaging and accounts for 42% of all plastics ever produced. Packaging is also the product with the shortest lifespan. Because most of it is designed for single-use, most plastic packaging leaves the economy the same year it is produced.

2.5.6.1 Plastic particles, plasticizers, and other chemical additives

When considering the human health impacts of plastics, one must distinguish between the impacts of plastic particles (micro- and nanoplastic particles) entering the human body and the impacts of the chemical additives, plasticizers, and contaminants associated with plastic particles. To date, most of the research on the impacts of micro- and nanoplastic particles has focused on impacts on marine life, while their impacts on human health have received less attention. There is emerging data demonstrating the presence of micro- and nanoparticles in plastics (including toxic chemical additives) in the food we eat, the air we breathe, and the water we drink, raising concerns among scientists about their potential impacts on human health.

Though our understanding of the impact of micro- and nanoparticles on plastics on human health is limited, the emerging body of research is raising fundamental questions about the historic belief that plastics are inert and safe. Increasingly, the research demonstrates that the same characteristics that make plastic material with diverse and desirable applications for bettering human life, that is, lightweight and incredibly durable molecular bonds, also make them widely dispersed, ubiquitous and a potential threat to human life and the ecosystems upon which humans rely.

More research has been conducted on plasticizers and other chemical additives in plastics and their health risks. However, there is still a significant dearth of information on the health impacts of toxic additives, and food packaging chemicals in particular, since only a handful of chemicals in use have gone through a health risk evaluation. A well-developed understanding of the impacts of plastics on human health is further hampered by limited information that quantifies the cumulative risks of chronic exposure.

2.5.6.2 Plasticizers used in plastics and other consumer products

The term plastics is used to refer to various types of polymers, which are synthesized from monomers that are polymerized to form macromolecular chains. Plastics can leach unreacted chemical monomers, some of which are hazardous. The plastics that are most hazardous based on carcinogenic monomer release include polyurethanes (flexible foam in furniture, bedding and carpet backing), polyvinyl chloride (pipes, packaging, wire and cable coatings, the monomer being vinyl chloride), epoxy resins (coatings, adhesives, and composites, such as carbon fiber and fiberglass) and polystyrene (food packaging, CD cases, hard plastics in consumer products and the monomer being styrene). In addition, the hormone-disrupting plasticizer BPA leaches as an unreacted monomer from polycarbonate plastic and epoxy can liners.

A wide array of chemicals and additives may be used in the manufacturing process to create a polymer, including initiators, catalysts and solvents. Additional chemical additives are used to provide various characteristics including stabilizers, plasticizers, flame retardants, pigments and fillers. They can also be used to inhibit photodegradation, to increase strength, rigidity, and flexibility, or to prevent microbial growth. Most of these additives are not bound to the polymer matrix, and due to their low molecular weight, they easily leach out of the polymer into the surrounding environment, including air, water, food or body tissues. As plastic particles continue to degrade, a new surface area is exposed, allowing continued leaching of additives from the core to the surface of the particle. A global analysis of all mass-produced non-fiber plastics showed that on average they contain 93% polymer resin and 7% additives by mass. Some polymers contain higher concentrations of toxic additives than others. Plasticizers are used to make plastic flexible, often comprising a significant portion of the final product, as much as 80% of all products. PVC is the monomer filled with the greatest diversity of additives, including heat stabilizers to keep the polymer stable, and plasticizers, such as phthalates, to make the polymer flexible. PP is highly sensitive to oxidation and therefore contains antioxidants and ultraviolet (UV) stabilizers.

MPs that accumulate in the body are a source of chemical contamination to tissues and fluids. A variety of chemical additives in plastics, plastic monomers, and plastic processing agents have known human health effects. For example, several plasticizers, such as bis (2-ethylhexyl) phthalate (DEHP) and BPA, can cause reproductive toxicity. Yet other harmful chemicals known to leach from plastic polymers include antioxidants, UV stabilizers, and nonylphenol (Table 2.11).

2.5.7 Potential threats associated with accumulated pollutants in plastic particles

Plastic is hydrophobic, meaning it tends to absorb hydrophobic POPs, such as PCBs and PAHs, while circulating in marine waters. The accumulated pollutants can concentrate to as much as 100 times background levels in seawater. Some of these chemicals have been found to desorb into tissues of marine species when ingested. While some recent studies have concluded that MP ingestion is unlikely to be a significant source of exposure for marine organisms to organic

Table 2.11 Plastics identified in MP debris and their relative hazard ranking.

Polymer Type	Density, g/cm ³	Relative Hazard Score ^a
Polyethylene (low, high density)	0.917–0.965	11
Polypropylene	0.9–0.91	1
Polystyrene	1.04–1.1	1628–30
Polyamide		63–50
polyethylene terephthalate	1.37–1.45	4
Polyvinylchloride	1.16–1.58	10 551–5001

^aRelative hazard score derived from different constituent monomers.

Higher ranking = greater hazard.

Adapted from [Galloway \(2015\)](#).

pollutants, a recent study in conditions simulating the digestive environment of warm-blooded organisms (38°C, pH 4) showed up to have 30 times faster desorption rates than in seawater. Therefore, it is likely that in mammals, including humans, the transfer of pollutants from inhaled or ingested plastic debris is more important than originally thought. The overall contribution of plastic debris contaminated with accumulated pollutants to the body burden (the total amount of toxic chemicals in the body) remains unanswered. In light of the projected increase of plastic accumulation in terrestrial and marine environments, a precautionary approach should be adopted while investigating this answer.

2.5.8 Food packaging chemicals

Because chemicals can migrate from packaging into food, the US Federal Food Drug and Cosmetics Act defines food packaging chemicals as indirect food additives. Migration of chemicals from food packaging into food and beverages is considered the main source of human exposure to contaminants associated with plastics. Some plastic polymers used for food contact degrade when they come into contact with acidic or alkaline foods, UV light, and heat. Toxic monomers like styrene are released in these conditions. Plastic additives are a diverse group of substances fulfilling various functions. Since they are often not tightly bound to the material, they are another common source of chemicals leaching into food. Non-intentionally added substances (NIAS) such as impurities, side products and contaminants additionally contribute to the migration or leaching of chemicals. In contrast, a few food packaging chemicals are designed to intentionally migrate out of the package to perform various functions, such as preventing foods from spoilage.

2.5.9 Human health effects related to plastic waste management

2.5.9.1 Environmental health impact of waste incineration

The waste incineration industry claims that incineration using highly advanced emission control technologies provides clean energy that reduces climate impacts and toxicity. However, extensive evidence demonstrates the harmful short- and long-term effects of emissions and by-products from waste incineration.

2.5.9.2 Air emissions associated with waste incineration

Metals (mercury, lead, and cadmium), organics (dioxins and furans), acid gases (sulfur dioxide and hydrogen chloride), particulates (dust and grit), nitrogen oxides and carbon monoxide can be emitted from incineration of plastics. Workers and nearby communities can be directly and indirectly exposed to these toxic emissions through inhaling contaminated air, touching contaminated soil or water, and ingesting foods that were grown in an environment polluted with these substances. These toxic substances pose a threat to vegetation, human and animal health, and the environment, and they persist and bio-accumulate through the food chain. Burning plastics also increases the fossil content of the energy mix and adds greenhouse gas emissions to the atmosphere. In some countries, newer incinerators apply air pollution control technologies, including fabric filters, electrostatic precipitators, and scrubbers. The filters do not prevent hazardous emissions, such as ultra-fine particles that are unregulated and particularly harmful to health, from escaping into the air. Malfunctions also tend to occur when the facility starts up and shuts down, or when the composition or volume of the waste changes, and these system failures result in greater emissions compared to normal operating conditions. It is estimated that in 2015, these kinds of airborne particulates caused the premature deaths of over four million people worldwide. Incinerators are also disproportionately built in low-income and socio-politically marginalized communities, burdening them with toxic ash and air pollution, noise pollution and accidents.

2.5.9.3 Toxic by-products of incineration on land and water

In addition to toxic air emissions, incineration technologies produce highly toxic by-products at various stages of thermal processing. Pollutants captured by air filtering devices are transferred to the byproducts of incineration, such as fly ash, bottom ash, boiler ash (also known as slag) and wastewater treatment sludge. Bottom ash comes from the furnace and is mixed with slag.

Fly ash is particulate matter in flue gases containing hazardous components, such as dioxin and furans, and are emitted from the stack. The toxicity in fly ash is greater than that in the bottom ash because they are small particles that are readily windborne and more likely to leach. At municipal waste incinerators, the more efficient the air pollution control system, the more toxic the ash is ([Table 2.12](#) and [Figure 2.28](#)).

2.6 IMPACT OF MP ON HUMAN HEALTH

2.6.1 Ingestion

MP can enter the human body via two main pathways: airborne through nasal passages into the lungs and ingestion through the mouth into the stomach. Ingestion of MPs via food consumption raises health concerns because of the potential translocation of particles from the digestive tract to other tissues and as a delivery mechanism for toxic chemicals. MPs contain an average of 4% of additives, but this can vary depending on the plastic type. Plastic additives such as phthalates, BPA and some flame retardants, are endocrine disruptors and carcinogens. It also shows that plastics can accumulate heavy metals and

Table 2.12 Compounds generated during the incineration of polyvinylchloride and their harmful effects.

Compound	Health Effect(s)
Acetaldehyde	Damages the nervous system, causing lesions.
Acetone	Irritates the eyes and the respiratory tract.
Benzaldehyde	Irritates the eyes, skin, respiratory system, and limits brain function.
Benzole	Carcinogenic, adversely affects the bone marrow, liver, and immune system.
Formaldehyde	Serious eye damage, carcinogenic, may cause pulmonary edema.
Phosgene	Gas used in WWI. Corrosive to the eyes, skin, and respiratory organs.
Polychlorinated dibenzo-dioxin	Carcinogenic, irritates the skin, eyes, and respiratory system. It damages the circulatory, digestive and nervous system, liver, and bone marrow.
Polychlorinated dibenzofuran	Irritates the eyes and the respiratory system, causes asthma.
Hydrochloric acid	Corrosive to the eyes, skin, and the respiratory tract.
Salicyl-aldehyde	Irritates the eyes, the skin, and the respiratory tract. It can also affect the central nervous system.
Toluene	Irritates the eyes and the respiratory tract can cause depression.
Xylene	Irritates the eyes. It can also affect the central nervous system, reduces the level of consciousness and impairs learning ability.
Propylene	Damages the central nervous system by lowering consciousness.
Vinyl chloride	Carcinogenic, irritating to the eyes, skin and respiratory system. Effect on the central nervous system, liver, spleen, and blood-forming organs.

Source: Alabi et al. (2019).

absorb toxic contaminants, such as PAHs and organochlorine pesticides from the surrounding water.

2.6.2 Ingesting MP particles

The potential impacts of ingesting microparticles have been studied for decades but are not yet fully understood because the particles are associated with such a diverse range of additives and contaminants. For example, the polyvinyl chloride particles have been transported from the digestive tract to the lymph and the circulatory systems, bile, cerebrospinal fluid, urine, lungs, and the milk of lactating animals. The interaction between MPs and other gut contents, including proteins, lipids, and carbohydrates, is highly complex. The accumulation of MP can lead to inflammation, tissue damage, cell death, and

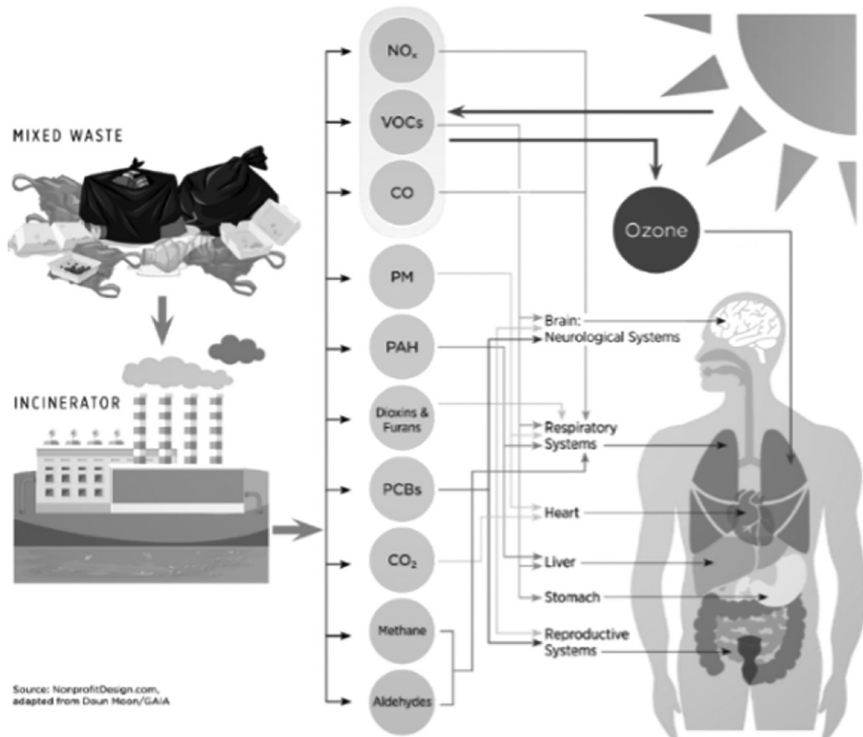

Figure 2.28 Toxic exposure from incineration (Source: Azoulay et al., 2019).

carcinogenesis. In addition, there is the potential for toxicological effects from harmful chemicals that leach or desorb from MP.

2.6.3 MPs and toxic chemicals

The possibility of chemical contaminants from MPs transferring to humans through food is not fully understood and warrants additional research. Uncertainties surround the health impacts of MPs ingestion, and scientists have suggested urgent research be undertaken, particularly on the potential effects on the endocrine system. Humans are exposed to MPs and associated chemicals that can be toxic even in low doses. Although plastics are only one source of chemical exposure, they could be a significant source of some toxic chemicals.

2.6.4 MP and the potential for disease

Another health concern relates to bacteria that grow in MPs. One study investigated a bacterium living on the surface of MPs collected from the North and Baltic seas. The bacterium can cause gastrointestinal illness in humans, and more research is needed to understand whether pathogens on the surface of MPs consumed by humans may present a serious disease risk.

2.6.5 Inhaling MPs

The fallout of airborne plastic particles may result in accumulation on the skin and on food, resulting in dermal and gastrointestinal exposure. Based on the reported indoor air concentrations and the average volume from air inhaled, researchers postulate that a person's lungs could be exposed to 26–130 airborne MPs/day. Other sources of airborne plastics include plastics and films used in agricultural processes that have degraded, fibers released from clothing dryers and sea-salt aerosol (i.e. caused by wave action). More recently, dust from vehicle tire wear has been acknowledged as one of the main sources of MP in the air. Airborne plastics can also be dispersed in global air currents.

2.6.6 Skin contacts of plastics in agricultural soil

One health concern regarding plastics in soils is the potential transfer of toxic chemicals to crops and animals. The plastic industry is a major source of chemical additives reaching the environment. Some of these additives, including endocrine-disrupting chemicals such as phthalates, polybrominated diphenyl ether (PBDEs) and bisphenol A have been found in fresh vegetables and fruit. Although pinpointing the precise source of a given contaminant is almost impossible, reports of plastic additives and toxic contaminants in vegetables and fruit serve as an early warning that should trigger the urgent implementation of the precautionary principle to reduce exposure.

Evidence of the indirect effects of plastic-associated chemicals is emerging in scientific literature. Earthworms that encounter polyurethane particles in soils can accumulate PBDEs. Earthworms are important to maintain healthy ecosystems and soils, particularly in agricultural regions. Worms aerate in the soil through burrowing, process detritus, move the soil, and are a key food source for other animals. It is possible that PBDEs could be transferred in worms to other areas of soil and through the food web (Figure 2.29).

2.6.7 Human illnesses and disabilities caused by MPs and carried chemicals

There is medical evidence linking the following human illnesses and disabilities to one or more POPs: Cancers and tumours, including soft-tissue sarcoma, non-Hodgkin's lymphoma, breast cancer, pancreatic cancer, and adult-onset leukemia; neurological disorders, including attention deficit disorder, behavior problems such as aggression and delinquency, learning disabilities, and impaired memory; and reproductive disorders, including abnormal sperm, miscarriages, pre-term delivery, low birth weight, altered sex ratios in offspring, shortened period of lactation in nursing mothers, and menstrual disorders.

2.6.8 Standards and guidelines for preventing the effects of plastics and MPs

The accumulation of plastics in the environment will ultimately have an impact on water and soil quality, and so a sustainable relationship with plastics is a necessity for the Anthropocene. Many years of research have gone into the plastic materials currently used, and thus their physical/chemical properties and costs are optimized from the point of view of manufacturers. Plastic

**Example of Multiple Pathways
for Human Exposure to Microplastics
through Seafood**

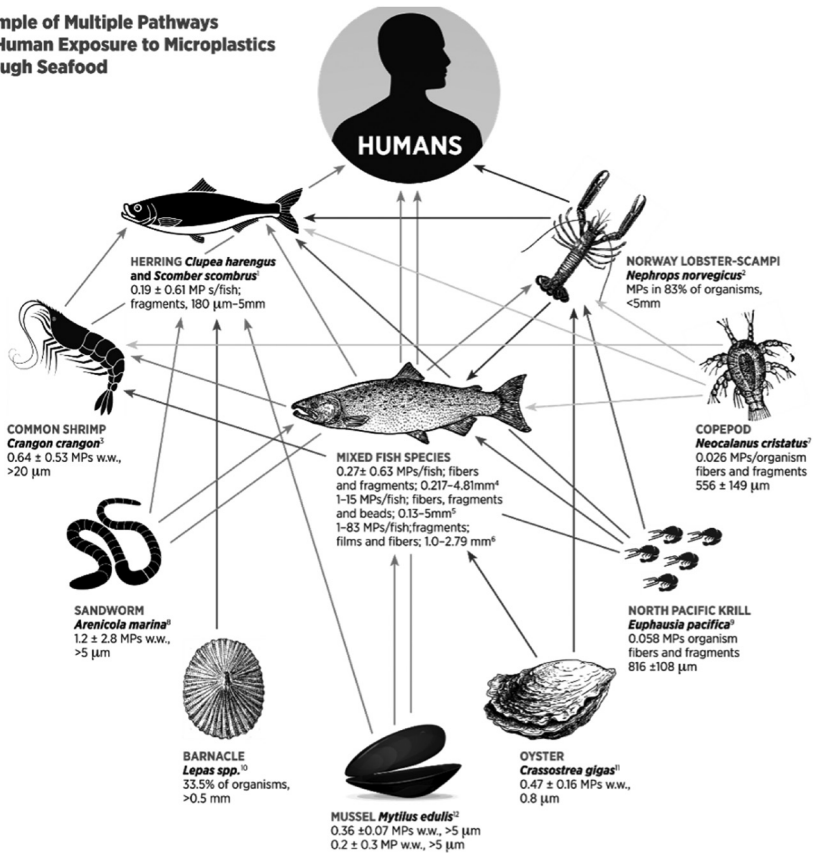

Figure 2.29 Multiple pathways for human exposure to MP through seafood (Source: Azoulay *et al.*, 2019).

opponents criticize plastic production and use because of all the externalities and impacts that cannot be fully characterized and controlled. With additional research and development, alternative materials may catch up in terms of both price and performance, but limited global resources should be targeted to scientifically defensible cases of increased sustainability, not too regrettable replacements or marketing stories. There is a need for an unbiased assessment of the hazard, fate and societal benefits of primary MPs throughout the regulatory process. Regulation should be enforceable and focused, and most importantly linked to hazards. The standards and guidelines for preventing the effects of plastics and MPs should be more rigorous. Then, the replacement of critical MPs can become an example of sustainable development and strict environmental regulations can stimulate innovation of new, more competitive, and environmentally conscious materials.

REFERENCES

- Abbasi S., Keshavarzi B., Moore F., Turner A., Kelly F. J., Dominguez A. O. and Jaafarzadeh N. (2019). Distribution and potential health impacts of microplastics and microrubbers in air and street dusts from Asaluyeh County, Iran. *Environmental Pollution*, **244**, 153–164.
- Allen S., Allen D., Phoenix V. R., Le Roux G., Durántez Jiménez P., Simonneau A., ... Galop D. (2019). Atmospheric transport and deposition of microplastics in a remote mountain catchment. *Nature Geoscience*, **12**(5), 339–344.
- Al-Malack M. H. (2001). Migration of lead from unplasticized polyvinyl chloride pipes. *J Hazard Mater*, **82**(3), 263–274.
- Andrady A. L. (2011). Microplastics in the marine environment. *Marine Pollution Bulletin*, **62**(8), 1596–1605.
- Andrady A. L. (2015). *Plastics and Environmental Sustainability*. John Wiley & Sons, New Jersey, USA.
- Alabi O. A., Ologbonjaye K. I., Awosolu O. and Alalade O. E. (2019). Public and environmental health effects of plastic wastes disposal: a review. *J Toxicol Risk Assess*, **5**(021), 1–13.
- Ašmonaitė G. and Almroth B. C. (2019). Effects of microplastics on organisms and impacts on the environment: balancing the known and unknown. Department of Biological and Environmental Sciences, University of Gothenburg, Sweden
- Au S. Y., Bruce T. F., Bridges W. C. and Klaine, S. J. (2015). Responses of *Hyalella azteca* to acute and chronic microplastic exposures. *Environmental Toxicology and Chemistry*, **34**(11), 2564–2572.
- Azoulay D., Villa P., Arellano Y., Gordon M. F., Moon D., Miller K. and Thompson K. (2019). *Plastic & Health: The Hidden Costs of a Plastic Planet*. CIEL, Washington DC, USA.
- Baldwin B. S. (1995). Selective particle ingestion by oyster larvae (*Crassostrea virginica*) feeding on natural seston and cultured algae. *Marine Biology*, **123**(1), 95–107.
- Besseling E., Wang B., Lürling M. and Koelmans A. A. (2014). Nanoplastic affects growth of *S. obliquus* and reproduction of *D. magna*. *Environmental Science & Technology*, **48**(20), 12336–12343.
- Bhattacharya P., Lin S., Turner J. P. and Ke P. C. (2010). Physical adsorption of charged plastic nanoparticles affects algal photosynthesis. *The Journal of Physical Chemistry C*, **114**(39), 16556–16561.
- Borgå K. (2013). *Ecotoxicology: Bioaccumulation*, Reference Module in Earth Systems and Environmental Sciences. Elsevier Science, Amsterdam, The Netherlands, pp. 346–348.
- Boucher J. and Friot D. (2017). *Primary Microplastics in the Oceans: A Global Evaluation of Sources*. IUCN, Gland, Switzerland, pp. 43.
- Bourne W. R. P. and Clark, G. C. (1984). The occurrence of birds and garbage at the Humboldt Front off Valparaiso, Chile. *Marine Pollution Bulletin*, **15**(9), 343–344.
- Browne M. A., Dissanayake A., Galloway T. S., Lowe D. M. and Thompson R. C. (2008). Ingested microscopic plastic translocates to the circulatory system of the mussel, *Mytilus edulis* (L.). *Environmental Science & Technology*, **42**(13), 5026–5031.
- Burian A., Nielsen J. M. and Winder M. (2020). Food quantity–quality interactions and their impact on consumer behavior and trophic transfer. *Ecological Monographs*, **90**(1), e01395, <https://doi.org/10.1002/ecm.1395>
- Cai L., Wang J., Peng J., Tan Z., Zhan Z., Tan X. and Chen Q. (2017). Characteristic of microplastics in the atmospheric fallout from Dongguan city, China: preliminary research and first evidence. *Environmental Science and Pollution Research*, **24**(32), 24928–24935.

- Chandra R. and Rustgi R. 1998. Biodegradable polymers. *Prog Polym Sci.*, **23**(7), 1273–1335.
- Chanpiwat P. and Damrongsiri S. (2021). Abundance and characteristics of microplastics in freshwater and treated tap water in Bangkok, Thailand. *Environmental Monitoring and Assessment*, **193**(5), 1–15.
- Chen G., Feng Q. and Wang J. (2020). Mini-review of microplastics in the atmosphere and their risks to humans. *Science of the Total Environment*, **703**, 135504, <https://doi.org/10.1016/j.scitotenv.2019.135504>
- Cirillo T., Fasano E., Castaldi E., Montuori P. and Amodio Cocchieri R. (2011). Children's exposure to di (2-ethylhexyl) phthalate and dibutylphthalate plasticizers from school meals. *Journal of Agricultural and Food Chemistry*, **59**(19), 10532–10538, <https://doi.org/10.1021/jf2020446>
- Cole M., Lindeque P., Fileman E., Halsband C., Goodhead R., Moger J. and Galloway T. S. (2013). Microplastic ingestion by zooplankton. *Environmental Science & Technology*, **47**(12), 6646–6655.
- Crosti R., Arcangeli A., Campana I., Paraboschi M. and González-Fernández D. (2018). 'Down to the river': amount, composition, and economic sector of litter entering the marine compartment, through the Tiber river in the Western Mediterranean Sea. *Rendiconti Lincei. Scienze Fisiche e Naturali*, **29**(4), 859–866.
- Costa S. and Teixeira J. P. (2014). Toxicology. In *Encyclopedia of Toxicology* (3rd edn.). Academic Press, Cambridge, Massachusetts, USA.
- Deng W. J., Zheng J. S., Bi X. H., Fu J. M. and Wong M. H. 2007. Distribution of PBDEs in air particles from an electronic waste recycling site compared with Guangzhou and Hong Kong, South China. *Environ Int.*, **33**(8), 1063–1069.
- Dris R., Gasperi J., Rocher V., Saad M., Renault N., and Tassin B. (2015). Microplastic contamination in an urban area: a case study in Greater Paris. *Environmental Chemistry*, **12**(5), 592–599.
- Dris R., Gasperi J., Saad M., Mirande C. and Tassin B. (2016). Synthetic fibers in atmospheric fallout: a source of microplastics in the environment?. *Marine Pollution Bulletin*, **104**(1–2), 290–293.
- Dris R., Gasperi J., Mirande C., Mandin C., Guerrouache M., Langlois V. and Tassin B. (2017). A first overview of textile fibers, including microplastics, in indoor and outdoor environments. *Environmental Pollution*, **221**, 453–458.
- Farrell P. and Nelson K. (2013). Trophic level transfer of microplastic: *Mytilus edulis* (L.) to *Carcinus maenas* (L.). *Environmental Pollution*, **177**, 1–3.
- Fangsrikum K., Paibulkichakul C. and Paibulkichakul B. (2021). Study on the amount of microplastics in Blue Swimming Crab around Map Ta Phut Industrial Estate, Mueang Rayong District, Rayong Province. *Khon Kaen Agriculture Journal*, **49**, 165–171.
- Faure F., Demars C., Wieser O., Kunz M. and De Alencastro L. F. (2015). Plastic pollution in Swiss surface waters: nature and concentrations, interaction with pollutants. *Environmental Chemistry*, **12**(5), 582–591.
- Fernández R. G. (2001). Artemia bioencapsulation I. Effect of particle sizes on the filtering behavior of *Artemia franciscana*. *Journal of Crustacean Biology*, **21**(2), 435–442.
- Fernandes A. R., Rose M. and Charlton C. (2008). 4-Nonylphenol (NP) in food-contact materials: Analytical methodology and occurrence. *Food Additives and Contaminants*, **25**(3), 364–372.
- Fotopoulou K. N. and Karapanagioti H. K. (2012). Surface properties of beached plastic pellets. *Marine Environmental Research*, **81**, 70–77.
- Fotopoulou K. N. and Karapanagioti H. K. (2015). Surface properties of beached plastics. *Environmental Science and Pollution Research*, **22**(14), 11022–11032, <https://doi.org/10.1007/s11356-015-4332-y>

- Galloway T. S. (2015). Micro- and nano-plastics and human health. In: Marine Anthropogenic Litter, M. Bergmann, L. Gutow and M. Klages (eds.). Springer, Cham, pp. 343–366.
- Göpferich A. (1996). Mechanisms of polymer degradation and erosion. *Biomaterials*, **17**(2), 103–114.
- Gillibert R., Balakrishnan G., Deshoules Q., Tardivel M., Magazzù A., Donato M. G., Maragò O. M., Lamy de La Chapelle M., Colas F., Lagarde F. and Gucciardi P. G. (2019). Raman Tweezers for small microplastics and nanoplastics identification in seawater. *Environmental Science & Technology*, **53**(15), 9003–9013, <https://doi.org/10.1021/acs.est.9b03105>
- Guo X. and Wang J. (2019). The chemical behaviors of microplastic in marine environment: A review. *Marine Pollution Bulletin*, **142**, 1–14, <https://doi.org/10.1016/j.marpolbul.2019.03.019>
- Gupta P. K. (2020). General toxicology. In: Problem Solving Questions in Toxicology, Springer, Cham, pp. 11–26.
- Harshvardhan K. and Jha B. (2013). Biodegradation of low-density polyethylene by marine bacteria from pelagic waters, Arabian Sea, India. *Marine Pollution Bulletin*, **77**(1–2), 100–106.
- Hua J., Vijver M. G., Richardson M. K., Ahmad F. and Peijnenburg W. J. (2014). Particle-specific toxic effects of differently shaped zinc oxide nanoparticles to zebrafish embryos (*Danio rerio*). *Environmental Toxicology and Chemistry*, **33**(12), 2859–2859.
- Keresztes S., Tatár E., Mihucz V. G., Virág I., Majdik C. and Zárny G. (2009). Leaching of antimony from polyethylene terephthalate (PET) bottles into mineral water. *Science of the Total Environment*, **407**(16), 4731–4735.
- Kim D. J. and Lee K. T. (2012). Determination of monomers and oligomers in polyethylene terephthalate trays and bottles for food use by using high performance liquid chromatography-electrospray ionization-mass spectrometry. *Polymer Testing*, **31**(3), 490–499.
- Kim Y. J., Osako M. and Sakai S. I. (2006). Leaching characteristics of polybrominated diphenyl ethers (PBDEs) from flame-retardant plastics. *Chemosphere*, **65**(3), 506–513.
- Klein M. and Fischer E. K. (2019). Microplastic abundance in atmospheric deposition within the Metropolitan area of Hamburg, Germany. *Science of the Total Environment*, **685**, 96–103.
- Kokalj A. J., Kunej U. and Skalar T. (2018). Screening study of four environmentally relevant microplastic pollutants: uptake and effects on *Daphnia magna* and *Artemia franciscana*. *Chemosphere*, **208**, 522–529.
- Kosuth M., Mason S. A. and Wattenberg E. V. (2018). Anthropogenic contamination of tap water, beer, and sea salt. *PLoS One*, **13**(4), e0194970, <https://doi.org/10.1371/journal.pone.0194970>
- Lambert S., Sinclair C. J., Bradley E. L. and Boxall A. B. (2013). Environmental fate of processed natural rubber latex. *Environmental Science: Processes & Impacts*, **15**(7), 1359–1368.
- Lambert S., Sinclair C., and Boxall A. (2014). Occurrence, degradation, and effect of polymer-based materials in the environment. *Reviews of Environmental Contamination and Toxicology*, **227**, 1–53.
- Lambert S., Scherer C. and Wagner M. (2017). Ecotoxicity testing of microplastics: considering the heterogeneity of physicochemical properties. *Integrated Environmental Assessment and Management*, **13**(3), 470–475, <https://doi.org/10.1002/ieam.1901>
- La Rocca A., Campbell J., Fay M. W. and Orhan O. S. M. A. N. (2016). Soot-in-oil 3D volume reconstruction through the use of electron tomography: an introductory study. *Tribology Letters*, **61**(1), 1–11.

- Lechner A., Keckeis H., Lumesberger-Loisl F., Zens B., Krusch R., Tritthart M., ... Schludermann E. (2014). The Danube so colourful: a potpourri of plastic litter outnumbers fish larvae in Europe's second largest river. *Environmental Pollution*, **188**, 177–181.
- Lechthaler S., Waldschläger K., Stauch G. and Schüttrumpf H. (2020). The way of macroplastic through the environment. *Environments*, **7**(10), 73, <https://doi.org/10.3390/environments7100073>
- Lee K. W., Shim W. J., Kwon O. Y. and Kang J. H. (2013). Size-dependent effects of micro polystyrene particles in the marine copepod *Tigriopus japonicus*. *Environmental Science & Technology*, **47**(19), 11278–11283.
- Li Q., Feng Z., Zhang T., Ma C. and Shi H. (2020). Microplastics in the commercial seaweed nori. *Journal of Hazardous Materials*, **388**, 122060, <https://doi.org/10.1016/j.jhazmat.2020.122060>
- Liu C., Li J., Zhang Y., Wang L., Deng J., Gao Y., ... Sun H. (2019a). Widespread distribution of PET and PC microplastics in dust in urban China and their estimated human exposure. *Environment International*, **128**, 116–124.
- Liu K., Wang X., Fang T., Xu P., Zhu L., and Li D. (2019b). Source and potential risk assessment of suspended atmospheric microplastics in Shanghai. *Science of the Total Environment*, **675**, 462–471.
- Liu X., Yuan W., Di M., Li Z. and Wang J. (2019c). Transfer and fate of microplastics during the conventional activated sludge process in one wastewater treatment plant of China. *Chemical Engineering Journal*, **362**, 176–182.
- Long M., Moriceau B., Gallinari M., Lambert C., Huvet A., Raffray J. and Soudant P. (2015). Interactions between microplastics and phytoplankton aggregates: impact on their respective fates. *Marine Chemistry*, **175**, 39–46.
- Lusher A. (2015). Microplastics in the marine environment: distribution, interactions and effects. In: *Marine Anthropogenic Litter*, Springer, Cham, pp. 245–307.
- Lusher A. L., Mchugh M. and Thompson R. C. (2013). Occurrence of microplastics in the gastrointestinal tract of pelagic and demersal fish from the English Channel. *Marine Pollution Bulletin*, **67**(1–2), 94–99.
- Mason S. A., Welch V. G and Neratko J. (2018) Synthetic Polymer Contamination in Bottled Water. *Front. Chem.* **6**, 407, <https://doi.org/10.3389/fchem.2018.00407>
- McCarthy N. (2018). Study Finds Microplastics In 93% Of Bottled Water. <https://www.forbes.com/sites/niallmccarthy/2018/03/16/study-finds-microplastics-in-93-percent-of-bottled-water-infographic/?sh=4e35741a73fa> (accessed 24 July 2021).
- Miloloža M., Kucic Grgic D., Bolanca T., Ukić Š., Cvetnić M., Ocelić Bulatović V., ... Kušić H. (2021). Ecotoxicological assessment of microplastics in freshwater sources – a review. *Water*, **13**(1), 56, <https://doi.org/10.3390/w13010056>
- Miraj S. S., Parveen N. and Zedan H. S. (2021). Plastic microbeads: Small yet mighty concerning. *International Journal of Environmental Health Research*, **31**(7), 788–804.
- Murray F. and Cowie P. R. (2011). Plastic contamination in the decapod crustacean *Nephrops norvegicus* (Linnaeus, 1758). *Marine Pollution Bulletin*, **62**(6), 1207–1217.
- Ory N. C., Sobral P., Ferreira J. L. and Thiel M. (2017). Amberstripe scad *Decapterus muroadsi* (Carangidae) fish ingest blue microplastics resembling their copepod prey along the coast of Rapa Nui (Easter Island) in the South Pacific subtropical gyre. *Science of the Total Environment*, **586**, 430–437.
- Peters C. A., Thomas P. A., Rieper K. B. and Bratton S. P. (2017). Foraging preferences influence microplastic ingestion by six marine fish species from the Texas Gulf Coast. *Marine Pollution Bulletin*, **124**(1), 82–88.

- Phothakwanpracha J., Lirdwitayaprasit T. and Pairohakul S. (2021). Effects of sizes and concentrations of different types of microplastics on bioaccumulation and lethality rate in the green mussel, *Perna viridis*. *Marine Pollution Bulletin*, **173**, 112954.
- Picó Y. and Barceló D. (2019). Analysis and prevention of microplastic pollution in water: current perspectives and future directions. *ACS Omega*, **4**(4), 6709–6719, <https://doi.org/10.1021/acsomega.9b00222>
- Pichel W. G., Churnside J. H., Veenstra T. S., Foley D. G., Friedman K. S., Brainard R. E., Nicoll J. B., Zheng Q. and Clemente-Colon P. (2007). Marine debris collects within the North Pacific subtropical convergence zone. *Marine Pollution Bulletin*, **54**(8), 1207–1211.
- Qian Z. H. O. U., ChongGuo T. I. A. N. and YongMing L. U. O. (2017). Various forms and deposition fluxes of microplastics identified in the coastal urban atmosphere. *Chinese Science Bulletin*, **62**(33), 3902–3909.
- Rochman C. M. (2015). The complex mixture, fate and toxicity of chemicals associated with plastic debris in the marine environment. In *Marine Anthropogenic Litter*, M. Bergmann, L. Gutow and M. Klages (eds). Springer, Cham, pp. 117–140.
- Rosenkranz P., Chaudhry Q., Stone V. and Fernandes T. F. (2009). A comparison of nanoparticle and fine particle uptake by *Daphnia magna*. *Environmental Toxicology and Chemistry: An International Journal*, **28**(10), 2142–2149.
- Scales K. L., Miller P. I., Hawkes L. A., Ingram S. N., Sims D. W. and Votier S. C. (2014). On the Front Line: Frontal zones as priority at-sea conservation areas for mobile marine vertebrates. *Journal of Applied Ecology*, **51**(6), 1575–1583.
- Schöneich-Argent R. I., Dau K. and Freund H. (2020). Wasting the North Sea?—A field-based assessment of anthropogenic macrolitter loads and emission rates of three German tributaries. *Environmental Pollution*, **263**, 114367.
- Schirinzi G. F., Köck-Schulmeyer M., Cabrera M., González-Fernández D., Hanke G., Farré M. and Barceló D. (2020). Riverine anthropogenic litter load to the Mediterranean Sea near the metropolitan area of Barcelona, Spain. *Science of the Total Environment*, **714**, 136807.
- Sekiguchi T., Saika A., Nomura K., Watanabe T., Watanabe T., Fujimoto Y., Enoki M., Sato T., Kato C. and Kanehiro H. (2011). Biodegradation of aliphatic polyesters soaked in deep seawaters and isolation of poly (ϵ -caprolactone)-degrading bacteria. *Polymer Degradation and Stability*, **96**(7), 1397–1403, <https://doi.org/10.1016/j.polymdegradstab.2011.03.004>
- Setälä O., Fleming-Lehtinen V. and Lehtiniemi M. (2014). Ingestion and transfer of microplastics in the planktonic food web. *Environmental Pollution*, **185**, 77–83.
- Shotyk W. and Krachler M. (2007). Contamination of bottled waters with antimony leaching from polyethylene terephthalate (PET) increases upon storage. *Environmental Science & Technology*, **41**(5), 1560–1563.
- Smith M., Love D. C., Rochman C. M. and Neff R. A. (2018). Microplastics in seafood and the implications for human health. *Current Environmental Health Reports*, **5**(3), 375–386, <https://doi.org/10.1007/s40572-018-0206-z>
- Thiel M., Luna-Jorquera G., Álvarez-Varas R., Gallardo C., Hinojosa I. A., Luna N., ... Zavalaga C. (2018). Impacts of marine plastic pollution from continental coasts to subtropical gyres – fish, seabirds, and other vertebrates in the SE Pacific. *Frontiers in Marine Science*, **5**, 238, <https://doi.org/10.3389/fmars.2018.00238>
- van Calcar C. V. and van Emmerik T. V. (2019). Abundance of plastic debris across European and Asian rivers. *Environmental Research Letters*, **14**(12), 124051.
- Van Cauwenberghé L., Vanreusel A., Mees J. and Janssen C. R. (2013). Microplastic pollution in deep-sea sediments. *Environmental Pollution*, **182**, 495–499.

- Van Emmerik T., Tramoy R., Van Calcar C., Alligant S., Treilles R., Tassin B. and Gasperi J. (2019). Seine plastic debris transport tenfolded during increased river discharge. *Frontiers in Marine Science*, **6**, 642.
- von Moos N., Burkhardt-Holm P. and Köhler A. (2012). Uptake and effects of microplastics on cells and tissue of the blue mussel *Mytilus edulis* L. after an experimental exposure. *Environmental Science & Technology*, **46**(20), 11327–11335.
- Vriend P., Van Calcar C., Kooi M., Landman H., Pikaar R. and Van Emmerik T. (2020). Rapid assessment of floating macroplastic transport in the Rhine. *Frontiers in Marine Science*, **7**, 10.
- Walsh P. J., Smith S., Fleming L., Solo-Gabriele H. and Gerwick W. H. (eds.). (2008). *Oceans and Human Health: Risks and Remedies from the Seas*. Elsevier, New York, USA.
- Watts A. J., Lewis C., Goodhead R. M., Beckett S. J., Moger J., Tyler C. R. and Galloway T. S. (2014). Uptake and retention of microplastics by the shore crab *Carcinus maenas*. *Environmental Science & Technology*, **48**(15), 8823–8830.
- Westerhoff P., Prapaipong P., Shock E. and Hillaireau A. (2008). Antimony leaching from polyethylene terephthalate (PET) plastic used for bottled drinking water. *Water Research*, **42**(3), 551–556.
- Wright, S. L. and Kelly, F. J. (2017). Plastic and human health: a micro issue?. *Environmental Science & Technology*, **51**(12), 6634–6647.
- Wright, S. L., Thompson, R. C. and Galloway, T. S. (2013). The physical impacts of microplastics on marine organisms: a review. *Environmental Pollution*, **178**, 483–492.
- World Health Organization. (2019). Microplastics in drinking-water. World Health Organization, Geneva, Switzerland. <https://apps.who.int/iris/handle/10665/326499>
- Yartsev, A. (2015). Graded dose-response curves. *Pharmacodynamics*. <https://derangedphysiology.com/main/cicm-primary-exam/required-reading/pharmacodynamics/Chapter%20412/graded-dose-response-curves> (accessed 17 December 2021).
- Yu F., Yang C., Zhu Z., Bai X. and Ma J. (2019). Adsorption behavior of organic pollutants and metals on micro/nanoplastic in the aquatic environment. *Science of the Total Environment*, **694**, 133643, <https://doi.org/10.1016/j.scitotenv.2019.133643>

Chapter 3

Marine ecosystems and emerging plastic pollution

Chongrak Polprasert, Thamasak Yeemin, Makamas Sutthacheep, Tatchai Pussayanavin, Kesirine Jinda and Sittikorn Kamngam

Table of Contents

3.1	Types and Sources of Plastic Pollution in Marine Ecosystems.	85
3.2	Plastic Degradation	88
3.3	Tangible and Intangible Impacts on Marine Life and Ecosystems	89
3.3.1	Tangible and entanglement.	89
3.3.2	Ingestion and intangible	92
3.4	Contaminations in Seafood and Their By-Products	94
3.5	Case Studies	96
3.5.1	Cases of entanglement in United States West Coast during 2017–2020.	96
3.5.2	Abundance, composition and fate of MP in water, sediment and shellfish in the Tapi-Phumduang River system and Bandon Bay, Thailand.	96
	References.	99
	Annex 3.1 Entanglement	103
	Annex 3.2 Ingestion	114

3.1 TYPES AND SOURCES OF PLASTIC POLLUTION IN MARINE ECOSYSTEMS

According to World Bank estimates, the world produces 2.01 billion tonnes of municipal solid waste each year, with at least 33% not being managed in an ecologically sustainable manner. By 2050, global garbage is anticipated to reach 3.40 billion tonnes, more than double the population increase. Littered waste deviates from ‘inadequately disposed’ waste in that it refers to plastics that have been dropped or disposed of in an improper area without consent. While high-income nations are far more likely to have better waste management systems

and have smaller amounts of improperly discarded garbage, littering can contribute to plastic pollution. [Jambeck *et al.* \(2015\)](#) assume estimated littering accounts for 2% of total plastic waste generation globally. Litter ending up in oceans or seas is known as marine litter, defined as ‘any persistent, produced or processed solid items discarded, disposed of, or abandoned in the marine and coastal environment,’ according to [UNEP \(2021\)](#). Recently, [Harris *et al.* \(2021\)](#) indicated coastal geomorphic type, plastic trapping efficiency, and the amount of plastic received had an inverse relationship. They found that although river-dominated coastlines make up just 0.87% of the worldwide shoreline, they get 52% of the plastic pollution delivered by fluvial systems. Mangrove and salt marsh ecosystems are most abundant along tide-dominated beaches, which receive 29.9% of river-borne plastic pollution. Indeed, mangroves’ inherent structural complexity enhances their potential to capture debris from both terrestrial, freshwater and marine sources, resulting in effects that are unique to the mangrove environment ([Luo *et al.*, 2020](#)).

According to estimations, only around 1% of plastic in the ocean floats to the surface. Since 1950, around 86 000 million kg of plastic have entered the ocean ([Jang *et al.*, 2015](#)) in which more than half of it float, resulting in about 57 000 million kg of floating plastic garbage. Between 60 and 64% of the plastic debris is estimated to have washed into the water from coastal regions ([Lebreton *et al.*, 2012](#)), implying that 34 000 million kg of floating plastic have made their way into the ocean. Currently, however, 93–236 million kg of plastic have been recorded floating on the ocean surface ([van Sebille, 2016](#)), equating to less than 1% of all plastic that has made its way into the ocean which implies that the other 99% are someplace else than the water’s surface.

The Great Pacific Garbage Patch (GPGP) floats in the open ocean with 1.8 trillion particles of plastic and weighs an estimated 80 000 tonnes of plastic, equivalent to 500 Jumbo Jets. The great majority of retrieved plastics are either rigid or hard polyethylene (PE) or polypropylene (PP), and abandoned fishing gear (nets and ropes in particular). Microplastics (MP) (0.05–0.5 cm), mesoplastics (0.5–5 cm), macroplastics (5–50 cm) and megaplastics (anything above 50 cm) are the four size classifications within the GPGP. They come in various sizes such as length-metred fishing nets. Some marine species are at high risk of unfavourable interactions with floating plastics if these islands are within the area of the subtropical gyres’ trash accumulation zones. [Lebreton *et al.* \(2018\)](#) investigated evidence that the GPGP is rapidly accumulating plastic and found that plastics were the most prevalent type of marine litter found, accounting for more than 99.9% of the 1 136 145 pieces and 668 kg of floating debris collected by trawls, and predicted that the GPGP contains a total of 1.8 trillion plastic pieces weighing 79 kilotonnes. MP account for 1.7 trillion pieces and 6.4 kilotonnes, mesoplastics for 56 billion pieces and 10 kilotonnes, macroplastics for 821 million pieces and 20 kilotonnes, and megaplastics for 3.2 million pieces and 42 kilotonnes. Megaplastics had the greatest reported mass concentration, at 46.3 kg/km² (min–max: 0.4–428.1 kg/km²), followed by macroplastics at 16.8 kg/km² (0.4–70.4 kg/km²), mesoplastics at 3.9 kg/km² (0.0003–88.4 kg/km²), and MP at 2.5 kg km² (0.07–26.4 kg km²). MP and mesoplastics were by far the most abundant, with mean numerical

Table 3.1 Mean observed mass and numerical concentrations within the 1.6 million km² GPGP for different sizes and types of ocean plastics.

Class Size	Type	Mean Mass Concentration (kg/km ²)	Mean Numerical Concentration (pieces/km ²)
MP (0.05–0.5 cm)	H	2.33	643 930
	N	0.041	19 873
	P	0.13	14 362
	F	0.001	216
Mesoplastic (0.5–5 cm)	H	3.68	20 993
	N	0.23	803
	P	0.0003	3.6
	F	0.003	12
Macroplastic (5–50 cm)	H	15.53	640
	N	1.27	49
	F	0.021	0.7
Megaplastic (>50 cm)	H	3.52	0.3
	N	42.82	3.3
Total		69.58	700 886

Source: [Lebreton et al. \(2018\)](#).

concentrations of 678 000 and 22 000 pieces/km² inside the GPGP, respectively, and macroplastics and megaplastics with 690 and 3.5 pieces/km², respectively. Containers, bottles, lids, bottle caps, package straps, eel trap cones, oyster spacers, rope, and fishing nets are all examples of plastic products that might be used. As shown in [Table 3.1](#), plastic-type H includes hard plastic pieces, plastic sheets and film; plastic-type N includes plastic lines, ropes, and fishing nets; plastic-type P includes pre-production plastic pellets, and plastic-type F includes foamed material pieces.

Because certain fish are ‘intended’ to become entangled in nets, estimating the occurrence of unintentional entanglement of fish species is problematic. ‘ghost fishing’ refers to the practice of capturing or ‘fishing’ marine animals after the gear has been lost at sea (also known as ‘ghost gear’). The types of gear that cause the most ghost fishing are listed.

- **Gillnet:** Gillnets are passive fishing gear constructed largely of monofilament that may be used in a variety of water depths. Even after the net falls apart in the water, the lost net continues to fish.
- **Pot and traps:** One of the most hazardous ghost gears is pot and traps. It works by luring fish in with bait. Making traps and labelling gear using biodegradable materials may be the most effective strategy to limit fishing effects.
- **Fish aggregating devices (FADs):** FADs are made from old purse seines and wrapped around the rafts to attract the fish.
- **Hooks and lines:** Hooks and lines are commonly employed to catch large-sized target species, but if they are lost, they can have negative

consequences for the ecology since they continue to catch sea turtles and mammals.

- **Trawl nets:** Trawl nets get lost when operating in rocky substrate and coral reef areas. This gear cannot catch more fish like other gears, but it can still entangle octopus and crabs.

Purse netting is frequently misplaced while in use. Because it does not have a large mesh size, after sinking to the seabed, this bulky equipment can capture little creatures and have an impact on biodiversity. According to Thomas *et al.* (2019), every year, around 640 000 tons of fishing waste, including ghost nets, buoys, lines, traps, and baskets, end up in the oceans. Old fishing gear accounts for around 10% of the plastic pollution in the oceans throughout the world. Plastic has already come into contact with 45% of the species mentioned in the IUCN Red List. Six percent of all nets, 9% of all traps, and 29% of all longlines are lost in the oceans and become marine waste annually. Zhang *et al.* (2020a, 2020b) reported that, based on 43 bottom trawl samples taken in 2019 from different spatial distribution, composition and abundance of plastic litters on the East China Seafloor, PE was the most common polymer, accounting for 42.83% of the total weight. The plastic products' surface areas and lengths ranged from 3.43 to 2842 cm² and 1.3 cm to 14.23 cm, respectively, and fishing equipment accounted for 23.87% of all plastic products.

Drift nets, traps, and fish collectors collectively known as fish aggregating devices (FADs) are the most common items lost as litter in the oceans across the world, posing the biggest threat to marine life. FADs kill 2.8–6.7 times more creatures for overfishing than the target species for which they are utilized, including vulnerable species like sharks. Between 81 000 and 121 000 FADs were utilized globally in 2013. Not only does old fishing equipment destroy marine life, due to mechanical forces such as abrasion, destruction and cover, it also causes tremendous damage to the undersea ecosystem. Old fishing equipment may be discovered in deep-sea mountains, which are regularly fished because of their biodiversity. Existing regional fisheries management organizations (RFMOs) control methods are either ineffective or poorly administered. An ambitious, legally enforceable ocean conservation agreement is needed to limit the lethal threat of obsolete fishing gear, with 30% of the world's oceans protected by 2030. In this chapter, the summarized cases are in Annex A3.1.

3.2 PLASTIC DEGRADATION

Plastic degradation is important in determining the destiny of plastics and their environmental consequences. Soils subjected to severe human influence are hotspots for the accumulation of plastic waste in the terrestrial environment. Plastic contamination is more sensitive in inland waterways, urban lakes and riverbanks. The ocean's current confluence zones, beaches and seafloors are all possible destinations for plastic debris in the marine environment. Plastics are degraded in the environment through abiotic and biotic processes including

chemical, physical and biological interactions. In the natural environment, typical plastics degrade slowly and are influenced by their properties as well as the conditions of the exposed environment. MP created during the decomposition of plastics have become a growing source of concern in recent years as they have become more prevalent and may pose a threat to the health of the ecosystem (Zhang *et al.*, 2021).

The type of polymer determines potential degradation pathways and products. UV light and oxygen are the two most critical variables that cause polymers with a carbon-carbon backbone to degrade, resulting in chain scission. Abiotic degradation is likely to occur before biodegradation because smaller polymer fragments created by chain scission are more susceptible to biodegradation. When heteroatoms are present in a polymer's main chain, photo-oxidation, hydrolysis and biodegradation take place. Plastic polymer degradation can result in low molecular weight polymer fragments, such as monomers and oligomers, as well as the production of new end groups, particularly carboxylic acids (Moldoveanu & David, 2002).

In recent years, the uncontrolled disposal of plastic debris into the marine environment has attracted a lot of attention. When plastic is exposed to sunshine, it undergoes a constant photo-ageing process and breaks down into smaller size fragments, which can harm species in the marine environment (von Moos *et al.*, 2012). Because plastic materials exposed to the environment typically contain a variety of additives, determining the impact of plastic additives on the ageing of MP in simulated seawater has been carried out to estimate the fragmentation process and the potential environmental harm caused by MP.

3.3 TANGIBLE AND INTANGIBLE IMPACTS ON MARINE LIFE AND ECOSYSTEMS

Many marine vertebrate species, including fish, seabirds, sea turtles, and marine mammals, interact with marine litter in the Southeast Pacific. After reviewing and synthesizing data from various sources, marine debris impacts at least 100 distinct species (see Annex 1), including entanglement or inclusion of plastics in marine animals, seabird nests and plastic ingestion.

3.3.1 Tangible and entanglement

Entanglement occurs when marine waste such as trawl netting fragments, plastic packing straps, and twine or cords entangle marine creatures, causing death or harm. Restricted movement, drowning, starvation and suffocating are among the symptoms of entanglement. As they swim or move in the ocean, marine animals such as whales, sharks, dolphins, seals, sea lions and sea turtles become entangled in fishing gear and other marine debris. Marine animal entanglement, a global issue for marine life, occurs in man-made materials, the most prevalent of which are plastics. Plastic loops or ropes easily become entangled in marine creatures' necks, bodies, limbs or mouths. It can cause long-term misery or death if not eliminated by animals or human intervention. Tables 3.2 and 3.3

show details of marine animal entanglements. Parton *et al.* (2019) performed a thorough literature review complimented with innovative data gathered from the news to examine entangled cartilaginous fishes. In all, 47 elasmobranch entanglement incidents (N = 557 animals) were reported in 26 scientific papers, affecting 16 distinct families and 34 species throughout all three main ocean basins. Ghost fishing gear was the most prevalent entangling object (74% of

Table 3.2 Whale entanglements during 2017–2020.

Year	Entanglement Materials	Number
2017	Lines and buoys	21
	Line (ropes from an unknown source)	18
	Traps	13
	Monofilament's line	10
	Nets	9
	Metal line	4
	Unknown	1
	Debris	1
2018	California Dungeness crab commercial trap fishery	7 (7 humpback)
	Washington Dungeness crab commercial trap fishery, including tribal fisheries	5 (3 grey, 2 humpback)
	Oregon Dungeness crab commercial trap fishery	2 (1 grey, 1 humpback)
	Commercial Dungeness crab commercial trap fishery, state unknown	1 (1 humpback)
	California commercial spot prawn trap fishery	1 (1 humpback)
	California recreational spot prawn trap fishery	1 (1 humpback)
	Gillnet fisheries	7 (3 grey, 4 humpback)
2019	California Dungeness crab	3
	Washington Dungeness crab	1
	Oregon Dungeness crab	1
	California Recreational Dungeness crab	1
	Dungeness crab and rock crab	1
	Commercial Dungeness crab, state unknown	1
	Gillnet	2
	Mooring buoy	1
Unknown	15	
2020	California Dungeness crab	1
	Washington Dungeness crab	1
	Oregon Dungeness crab	1
	Gillnet	4
	Spot prawn	1
	Unknown	9

Source: [NOAA Fisheries report \(2021\)](#).

Table 3.3 Number and percentage (within parentheses) of seabirds by species and by type of entanglement material during 2008–2018.

Seabirds	Fishing Hook	Fishing Line	Fishing Net	Other Marine Debris	Total
Razorbill (<i>Alca torda</i>)	0	0	2 (100%)	0	2
Cory's shearwater (<i>Calonectris borealis</i>)	1 (100%)	0	0	0	1
Black-headed gull (<i>Chroicocephalus ridibundus</i>)	0	0	1 (50%)	1 (50%)	2
Common loon (<i>Gavia immer</i>)	1 (100%)	0	0	0	1
European storm petrel (<i>Hydrobates pelagicus</i>)	0	0	1 (100%)	0	1
Audouin's gull (<i>Larus audouinii</i>)	1 (100%)	0	0	0	1
Lesser black-backed gull (<i>Larus fuscus</i>)	6 (26%)	7 (30%)	2 (9%)	8 (35%)	23
Great black-backed gull (<i>Larus marinus</i>)	2 (25%)	5 (63%)	1 (13%)	0	8
Yellow-legged gull (<i>Larus michahellis</i>)	18 (44%)	10 (24%)	2 (5%)	1 (27%)	41
Northern gannet (<i>Morus bassanus</i>)	61 (54%)	19 (17%)	17 (15%)	16 (14%)	113
Great shearwater (<i>Puffinus gravis</i>)	0	0	1 (100%)	0	1
Balearic shearwater (<i>Puffinus mauretanicus</i>)	0	1 (17%)	5 (83%)	0	6
Arctic tern (<i>Sterna paradisaea</i>)	1 (100%)	0	0	0	1
Total	91 (45%)	42 (21%)	32 (16%)	36 (18%)	201

Source: Costa *et al.* (2020).

animals), followed by PP strapping bands (11% of animals), with other entangling materials such as circular plastic garbage, PE bags, and rubber tyres accounting for 1% of total entangled animals. The majority of instances were from the Pacific and Atlantic seas (49 and 46%, respectively), with a preference for the United States (44% of animals). Seventy-four occurrences of elasmobranch entanglement were discovered while monitoring social media, covering 14 families and 26 species. Ghost fishing gear was the most prevalent entanglement material (94.9% of animals) on Twitter, with the bulk of entanglement reports coming from the Atlantic Ocean (89.4% of total entangled animals).

The location of the corals in Koh Tao, southern Thailand in reference to damage to coral reefs caused by abandoned fishing gear was recorded by Ballesteros *et al.* (2018). Nets were the most frequent kind of lost gear (107), followed by lines (21), ropes (13) and cages (2), while branching corals were the most common species of coral discovered in contact with and surrounding the gear. The coral behind the gear had the most damage, which was mostly tissue loss (Table 3.4).

Table 3.4 Summary of pollution and coral damage caused by derelict fishing gear on coral reefs around Koh Tao, southern Thailand.

Total Number of Fishing Gear	Total Damaged Coral	Categories of Coral Damage	Coral Growth Forms	Entanglement by Category	Location
143	226	<ul style="list-style-type: none"> • Fresh tissue loss (FTL) • Tissue loss with algal growth (TLAG) and • Fragmentation (FR). 	<ul style="list-style-type: none"> • Branching • Encrusting • Foliaceous • Free-living • Laminar and • Massive 	Fishing gear (nets, ropes, cages, lines)	Around Koh Tao, a small island in the Gulf of Thailand

3.3.2 Ingestion and intangible

The rapid growth rate of plastic used and mismanaged plastic waste, along with the extended lifespan of plastic products, has resulted in a long-term temporal change in the danger of plastic ingestion, as seen by variations in the occurrence and volume of plastic consumed by marine creatures. Plastic usage is concentrated in heavily populated regions, and low-density plastics entering the sea follow rather predictable distribution patterns. Animal plastic consumption rises in response to changes in exposure and area. In several circumstances, ingestion rates have declined since 1980s. However, at least among seabirds, alterations in the content of ingested plastic have been detected. In nations with inadequate solid waste management infrastructure, a large number of plastic items are utilized in single-use applications and are easily carried into the marine environment by run-off or other natural processes. As a result, the vulnerability of animals to ingesting high amounts of marine plastics rises. Plastics found in various sizes (nano (1–100 nm), micro (1–5 mm), and macro-particles (>25 mm)) ingested by marine animals are among the most severe problems.

According to [Ryan \(2016\)](#), ingestion of plastics by marine species can be determined by various factors. The age of a species can influence its response to prey and its pace of intake. Plastics may be mistaken for food by younger animals due to its appearance and the animals' lack of experience. As a result, the rate of plastic ingestion rises, especially among the younger species as in the case of Thailand's dugong baby. Based on the autopsy, the juvenile sea cow perished due to complications caused by plastic consumption. As a result, it is reasonable to conclude that if the sea cow had not been so young and inexperienced in determining what is edible, it would not have consumed the plastic components that ultimately contributed to its death. In addition, plastic particles remain in the stomach for a long time before they are small enough to be excreted. Regurgitation and/or excretion are the most common methods used by marine creatures to deal with indigestible prey. Excretion may take some time depending on the size of the particles, as it does for many seabirds, due to the shape of the digestive system ([Van Franeker and Law, 2015](#)). Turtles and albatrosses, for example, use these methods to deal with ingested plastics. Overall, the size of a plastic particle in comparison to the size of an animal is critical to understanding how the two interact. The higher the surface area of the particles, the greater

the contact between the species and the plastic materials. There are two main theories for why marine creatures consume plastic: (1) they are opportunistic feeders that eat plastic wherever they come across it, and (2) they eat plastic because it is mistaken for prey visually. Plastics can be bioaccumulated and transferred along the food chain to other species that consume those animals, such as their prey, as a consequence of their ingestion by lower trophic level animals. In this chapter, the summarized cases are in Annex A3.2.

Plastics occur in a variety of colours, making it difficult for marine creatures to distinguish between true food and plastics. As a result, there is a considerable risk of mistaking plastics for food, increasing the ingestion rate even further. Food supply has been shown in various studies to impact the rate of plastic ingestion by marine creatures. MP absorption was negatively influenced by the relative availability of the presence of algae, even at low concentrations (Aljaibachi & Callaghan, 2018). The effects of 2 μm polystyrene MP on *Daphnia magna* mortality and reproduction in relation to food availability (algae *Chlorella vulgaris*) were investigated. As a result, *Daphnia magna* was selectively eating the algae than MP. The study found that no toxic effect after a 96 h of exposure although 7 days of exposure to high concentration of MPs increased mortality. Mortality, reproduction and growth rate were mainly linked to food concentrations (algae) rather than MPs.

Although there is no evidence that water quality influences the likelihood of plastic ingestion by marine animals, experiences show that water bodies with high turbidity are more likely to have plastic ingestion. This logical conclusion is reached because water with high turbidity has poor vision, resulting in the probability of greater plastic ingestion due to the incapacity of some marine animals to distinguish between plastics based on their colour spectrum.

Even though plastic polymers are biochemically inert, they can interact and have harmful consequences for humans and the environment. The polymer matrix, additives, breakdown products, and/or adsorbed pollutants can all contribute to plastic toxicity.

Plastics are oligomers/polymers composed of monomer building components. PE, for example, is made from the polymerization of ethylene (C_2H_4) monomers, which belong to the alkene family of organic molecules. Many chemical components employed in plastic manufacture may be released during the plastic's entire life cycle, creating a possible human health risk, environmental issues, and recycling system difficulties, but only a few of these compounds have been investigated. The potential for contaminated MP to transfer toxic chemicals (polycyclic aromatic hydrocarbon or pyrene) to exposed mussels *Mytilus galloprovincialis* was also demonstrated; MP were found in haemolymph, gills, and primarily digestive tissues, where pyrene was found in high concentrations. Among the cellular modifications were immunology changes. The composition of plastic materials under various environmental conditions and variables is complicated. It is a common misconception that all plastics are inert and have the same chemical composition. Plastic manufacturers, aquatics, terrestrials and atmospheric scientists, health care professionals, waste and chemical engineers, economists, regulators, and others must work together to better understand the composition and nature of plastic products, including additives, to answer critical questions and mitigate potential consequences.

Table 3.5 Bioconcentration and effects of chemical additives in plastics.

S/N	Chemical Additives	Abbreviation	Log K_{ow}	Effects
1	Butyl benzyl phthalate	BBP	4.70	Endocrine disruptors
2	Di(2-ethylhexyl) phthalate	DEHP	7.73	Endocrine disruptors
3	Diethyl phthalate	DEP	2.54	Endocrine disruptors
4	Diisobutyl phthalate	DiBP	4.27	Endocrine disruptors
5	Diisodecyl phthalate	DiDP	9.46	Endocrine disruptors
6	Diisononyl phthalate	DiNP	8.60	Endocrine disruptors
7	Dimethyl phthalate	DMP	1.61	Endocrine disruptors
8	Di- <i>n</i> -butyl phthalate	DnBP	4.27	Endocrine disruptors
9	Di- <i>n</i> -octyl phthalate	DnOP	7.73	Endocrine disruptors
10	Hexabromocyclododecane	HBCD	5.07–5.47	Endocrine disruptors
11	Polybrominated diphenyl ether	PBDE	5.52–11.22	Endocrine disruptors
12	Tetrabromobisphenol	ATBBPA	4.5	Endocrine disruptors
13	Bisphenol A	BPA	3.40	Endocrine disruptors
14	Nonylphenol	NP	4.48–4.80	Endocrine disruptors

Source: [Hermabessiere et al. \(2017\)](#).

Due to the fact that MP has been shown to be a vector of environmental contaminants to marine organisms for a variety of compounds, future research should focus on determining the relative importance of MP in comparison to other sources of particulate matter in the marine environment. Chlorpyrifos (CPF) was recently discovered to have a higher median lethal concentration ($LC_{50} = 1.34$ g/L) than MP ($LC_{50} = 0.37$ g/L) or CPF-loaded MP ($LC_{50} = 0.26$ g/L). CPF had significant effects on feeding and egg production ($EC_{50} = 0.77$ and 1.07 g/L for CPF, 0.03 and 0.05 g/L for CPF mixed with MP, 0.18 and 0.20 g/L for CPF-loaded MP). When ‘virgin’ MP was exposed, no substantial impacts were seen (Juan *et al.*, 2020). Plastics have chemical additives that act as plasticizers or flame retardants. They can also potentially damage organisms as well as taint the food chain. [Table 3.5](#) lists the principal plastic additives and their corresponding octanol–water partition coefficients, as well as bioconcentration and impacts of chemical additions in plastics (K_{ow}). A rise in $\log K_{ow}$ suggests an increase in the potential bioconcentration in organisms, and it has been used to forecast how a chemical may concentrate in marine species.

3.4 CONTAMINATIONS IN SEAFOOD AND THEIR BY-PRODUCTS

MP and related hazardous compounds in plastic food packaging and drinking water are important causes of food contamination. Infection, however, is not limited to packaged foods; natural food chains can also be a source of human contamination ([Table 3.6](#)). Although the majority of research to date has focused on seafood, there is a large knowledge gap. MP has been detected in a variety of economically significant species and people; nevertheless, the bulk of MP

Table 3.6 MP in animal and seafood.

Study Area	Species	Types of MP	LC ₅₀ * (Items/ Individule)	Reference
Marine Science Department, Chulalongkorn University	Juvenile tiger shrimp (<i>Penaeus monodon</i>)	PS <30 µm	25	Phothakwanpracha et al. (2021)
		PS 30–300 µm	19	
		PS 300–1000 µm	19	
Maptaphut, Rayong province	Blue swimming crab	PET, PP, PS, polyester, nylon	1.30	Fangsrikum et al. (2021)
		Goldstripe sardinella	PET, PE, PP, nylon	
	Silver sillago	PET, polyester, nylon	1.88	
	Green mussel	PET, PE, PP	0.75	
2 Salt brands	Sea salt	PET, PE, PP, PVC	80–600 parties/kg	Kim et al. (2018)

ingestion from ‘seafood’ comes from species consumed whole, such as mussels, oysters, shrimp, crabs and some tiny fish. MP contamination of other seafood, such as fish muscle tissue, may not be confined to ingestion of the species indicated above; it is likely that other seafood, such as fish muscle tissue, may be polluted either inside the organism or during preparation. MP particles have also been discovered in commercial table salt made from sea, lake, or rock salt.

The abundance and distribution of MP in dried anchovy products purchased from local fishing markets in the Western Gulf of Thailand are quantified by [Phaoduang et al. \(2021\)](#). Based on samples from five dried anchovy products, the quantity of MP in dried anchovy fish ranged from 0.47 to 3.18 particles per gram, with MP ranging in size from 109 to 1 006 µm. This study reveals that dried anchovies may be contaminated with MP, raising concerns about seafood safety and human health. Similarly, [Lira et al. \(2020\)](#) also found that fermented fish pastes (Bagoong) are among the most widely used liquid condiments in Asian countries, albeit fish paste manufacture varies from region to country. Balayan is a municipality in the province of Batangas in the Philippines that is known for its Bagoong Balayan. A total of 29 compounds passed the required match factor of 80, with 14 found in all of the fish paste samples collected. After centrifugation, vacuum filtering and microscope examination, MP were found in all of the samples. The majority of the MP found were fibrous in form and red or blue in colour. Human consumers may be subjected to MP pollution from fisheries-targeted species. In addition, a recent study from Thailand found contaminated samples of shrimp paste obtained from five provinces in the Andaman Sea and the Gulf of Thailand. MP concentrations in shrimp paste ranged from 6 to 11.3 particles/10 g, according to the findings. The MP were made up of fibres and pieces with lengths ranging from 0.1 to 1.0 mm. Polyethylene terephthalate (PET), polyurethane, rayon, PS, and polyvinyl alcohol were the five separate forms of plastic polymers found ([Sutthacheep et al., 2021](#)).

3.5 CASE STUDIES

3.5.1 Cases of entanglement in United States West Coast during 2017–2020

NOAA Fisheries confirmed 76 cases of large whale entanglement along the United States' coasts in 2017. This number represented are: 49 humpback whales, 11 grey whales, 7 minke whales, 3 blue whales, 2 north Atlantic right whales, 2 unidentified whales, 1 fin whale and 1 Sei whale. Forty-six whales were entangled off the coasts of Washington, Oregon and California in 2018, according to NOAA Fisheries. Humpback whales remain the most commonly entangled species, with 34 confirmed entanglements in 2018. Eleven grey whales and 1 fin whale were also reportedly entangled. Seven of the verified (5 humpback whales and 2 grey whales) were reported as dead due to entanglement, while the rest survived. NOAA Fisheries reported entanglement reporting on the United States West Coast in 2019, with a total of 26 whales confirmed entangled off the coasts of Washington, Oregon and California. Humpback whales remain the most often entangled species, with 17 confirmed entanglements, 8 grey whale entanglements, and 1 confirmed minke whale entanglement. In southern California, a dead leatherback sea turtle was discovered entangled in rock crab gear.

NOAA Fisheries reported 17 entangled whales off the coastlines of Washington, Oregon and California, or off the coasts of other nations but entangled by United States commercial fishing gear, in 2020. Ten humpback whales, 6 grey whales, and 1 sperm whale were entangled as summarized in [Table 3.7](#).

3.5.2 Abundance, composition and fate of MP in water, sediment and shellfish in the Tapi-Phumduang River system and Bandon Bay, Thailand

MP pollution in the environment is a global challenge, as shown by a growing number of studies. According to a recent survey in Thailand, the Tapi-Phumduang River system ($n = 10$) and Bandon Bay ($n = 5$) were sampled for water and sediment. The green mussels (*Perna viridis*) and lyrate Asiatic hard clam (*Meretrix lyrata*), two commercial bivalve species produced in the bay, were also studied. It was found that MP were identified in greater numbers in the river system than in the bay. One-third of the MP entering the bay was swept back upstream during high tide during the tidal cycle. The majority of the MP in this backflow was bigger. The daily average load of MP delivered to the bay was 22.4×10^9 items. The load was roughly 4–5 times higher during low tide than during high tide. The total buildup of MP in the river's bottom sediments and the bay's bottom sediments were comparable ($p < 0.05$). Green mussels have substantially more MP contamination than clams. The little shellfish had significantly more particles (items/g) than the large ones ($p < 0.05$). Fibres were found in nearly all samples, including water (98%), sediment (94%), mussels (100%), and clams (100%) (95%). Microfibres (<1 mm) were found in 71% of the water, 63% of the sediment, 63% of the green mussels, and 63% of the clams (52%). The most common hues were blue and white, with rayon being the most common polymer, followed by PP or PE, PET and nylon. These MP may eventually wind up in sediments and biological animals.

Table 3.7 Summary of cases of entanglement in marine animals.

Entangled Marine Animals	Family	Common Name	Species	Types/Shape of Entanglement	Location	Study Period
Marine mammal	Balaenopteridae	Humpback whale	<i>Megaptera novaeangliae</i> (46)	Fishing gear (line and buoys, traps, monofilament lines, and nets). Ropes, lines, nets, chains, and cables),	U.S. Coast	2017
Marine mammal	Eschrichtiidae	Grey whale	<i>Eschrichtius robustus</i> (11)	Fishing gear	U.S. Coast	2017
Marine mammal	Balaenopteridae	Minke whale	<i>Balaenoptera</i> spp. (7)	Fishing gear	U.S. Coast	2017
Marine mammal	Balaenopteridae	Blue whale	<i>Balaenoptera musculus</i> (5)	Fishing gear	U.S. Coast	2017
Marine mammal	Balaenidae	North Atlantic right whale	<i>Eubalaena glacialis</i> (2)	Fishing gear	U.S. Coast	2017
Marine mammal	Balaenopteridae	Fin whale	<i>Balaenoptera physalus</i> (1)	Fishing gear	U.S. Coast	2017
Marine mammal	Balaenopteridae	Sei whale	<i>Balaenoptera borealis</i> (1)	Fishing gear	U.S. Coast	2017
Marine mammal	Balaenopteridae	Humpback whale	<i>Megaptera novaeangliae</i> (34)	Dungeness crab fishing, Commercial trap fishery, commercial spot prawn trap fishery	California, Oregon, Washington and Mexico	2018

(Continued)

Table 3.7 Summary of cases of entanglement in marine animals. (Continued)

Entangled marine animals	Family	Common name	Species	Types/shape of entanglement	Location	Study period
Marine mammal	Eschrichtiidae	Grey whale	<i>Eschrichtius robustus</i> (11)	Oregon Dungeness crab commercial trap fishery	California,	2018
Marine mammal	Balaenopteridae	Fin whale	<i>Balaenoptera physalus</i> (1)	Fishing gear	CA, WA and ORG	2018
Marine mammal	Balaenopteridae	Humpback whale (17)	<i>Megaptera novaeangliae</i>	Commercial Dungeness crab gear	13 California, 3 Washington and 1 Mexico	2019
Marine mammal	Eschrichtiidae	Grey whale (8)	<i>Eschrichtius robustus</i>	Commercial Dungeness crab gear	3 California, 4 Oregon and 1 Washington	2019
Marine mammal	Balaenopteridae	Minke whale (1)	<i>Balaenoptera</i> spp.	Commercial Dungeness crab gear	1 California	2019
Sea turtle	Dermochelyidae	Leatherback sea turtle	<i>Dermochelys coriacea</i>	Rock crab gear	1 California	2019
Marine mammal	Balaenopteridae	Humpback whale (10)	<i>Megaptera novaeangliae</i>	2 commercial Dungeness crab gear, 2 unidentified gillnet, 1 commercial spot prawn gear, 5 unknown	8 CA, 1 OR, 1 WA-USA	2020
Marine mammal	Eschrichtiidae	Grey whale (6)	<i>Eschrichtius robustus</i>	Commercial Dungeness crab gear	4 CA, 2 WA	2020
Marine mammal	Physeteridae	Sperm whale (1)	<i>Physeter macrocephalus</i>	Unidentified monofilament line	1 CA	2020

REFERENCES

- Akoueson F., Sheldon L. M., Danopoulos E., Morris S., Hotten J., Chapman E., Li J. and Rotchell J. M. (2020). A preliminary analysis of microplastics in edible versus non-edible tissues from seafood samples. *Environmental Pollution*, **263**, 114452.
- Aljaibachi R. and Callaghan A. (2018). Impact of polystyrene microplastics on *Daphnia magna* mortality and reproduction in relation to food availability. *Peer J*, **6**, e4601, <https://doi.org/10.7717/peerj.4601>
- Ballesteros L. V., Matthews J. L. and Hoeksema B. W. (2018). Pollution and coral damage caused by derelict fishing gear on coral reefs around Koh Tao, Gulf of Thailand. *Marine Pollution Bulletin*, **135**, 1107–1116, <https://doi.org/10.1016/j.marpolbul.2018.08.033>
- Bernardini I., Garibaldi F., Canesi L., Fossi M. C. and Bainsi M. (2018). First data on plastic ingestion by blue sharks (*Prionace glauca*) from the Ligurian Sea (North-Western Mediterranean Sea). *Marine Pollution Bulletin*, **135**, 303–310, <https://doi.org/10.1016/j.marpolbul.2018.07.022>
- Capapé C., Rafrafi-Nouira S., Amor K. O. B. and Amor M. M. B. (2018, July). Additional records of sandbar shark, *Carcharhinus plumbeus* (Chondrichthyes: Carcharhinidae) from the northern Tunisian coast (central Mediterranean Sea). In *Annales: Series Historia Naturalis* (Vol. 28, No. 2, pp. 99–104). Scientific and Research Center of the Republic of Slovenia.
- Capillo G., Savoca S., Panarello G., Mancuso M., Branca C., Romano V., D'Angelo G. Bottari T. and Spanò N. (2020). Quali-quantitative analysis of plastics and synthetic microfibers found in demersal species from Southern Tyrrhenian Sea (Central Mediterranean). *Marine Pollution Bulletin*, **150**, 110596, <https://doi.org/10.1016/j.marpolbul.2019.110596>
- Carlin J., Craig C., Little S., Donnelly M., Fox D., Zhai L. and Walters L. (2020). Microplastic accumulation in the gastrointestinal tracts in birds of prey in central Florida, USA. *Environmental Pollution*, **264**, 114633, <https://doi.org/10.1016/j.envpol.2020.114633>
- Chen K.-J., Chen M.-C. and Chen T.-H. (2021). Plastic ingestion by fish in the coastal waters of the Hengchun Peninsula, Taiwan: associated with human activity but no evidence of biomagnification. *Ecotoxicology and Environmental Safety*, **213**, 112056.
- Clause A. G., Celestian A. J. and Pauly G. B. (2021). Plastic ingestion by freshwater turtles: a review and call to action. *Scientific Reports*, **11**, 5672, <https://doi.org/10.1038/s41598-021-84846-x>
- Collard, F., Gilbert, B., Eppe, G., Roos, L., Compère, P., Das, K. and Parmentier, E. (2017). Morphology of the filtration apparatus of three planktivorous fishes and relation with ingested anthropogenic particles. *Marine Pollution Bulletin*, **116**(1–2), 182–191.
- Costa R. A., Sa S., Pereira A. T., Angelo A. R., Vaqueiro J., Ferreira M. and Eira C. (2020). Prevalence of entanglements of seabirds in marine debris in the central Portuguese coast. www.elsevier.com/locate/marpolbul
- De-la-Torre G. E., Dioses-Salinas D. C., Pérez-Baca B. L., Cumpa L. A. M., Pizarro-Ortega C. I., Torres F. G., Gonzales K. N. and Santillán L. (2021). Marine macroinvertebrates inhabiting plastic litter in Peru. *Marine Pollution Bulletin*, **167**, 112296.
- Dixon E. (2019). Baby Dugong that Became a Thai Internet Star Died with Plastic Waste in its Stomach. CNN, Atlanta, Georgia, USA. <https://edition.cnn.com/2019/08/17/asia/thailand-baby-dugong-dies-scli-intl/index.html> (Accessed 20 June 2021)
- Donnelly-Greenan L. E., Nevins H. M. and Harvey J. T. (2019). Entangled seabird and marine mammal reports from citizen science surveys from coastal California

- (1997–2017). *Marine Pollution Bulletin*, **149**, 110557. www.elsevier.com/locate/marpolbul, <https://doi.org/10.1016/j.marpolbul.2019.110557>
- Eastman C. B., Farrell J. A., Whitmore L., Rollinson Ramia D. R., Thomas R.S., Prine J., Eastman S. F., Osborne T. Z., Martindale M. Q. and Duffy D. J. (2020). Plastic ingestion in post-hatchling sea turtles: assessing a major threat in Florida near shore waters. *Frontiers in Marine Science*, **7**, 693. <https://doi.org/10.3389/fmars.2020.00693>
- Fangsrikum K., Paibulkichakul C. and Paibulkichakul, B. (2021). Study on the amount of microplastics in Blue Swimming Crab around Map Ta Phut Industrial Estate, Mueang Rayong District, *Rayong Province. Khon Kaen Agriculture Journal*, **49**, 165–171.
- Hamilton B. M., Bourdages M. P. T., Geoffroy C., Vermaire J. C., Mallory M. L., Rochman C. M. and Provencher J. F. (2021). Microplastics around an Arctic seabird colony: particle community composition varies across environmental matrices. *Science of the Total Environment*, **773**, 145536, <https://doi.org/10.1016/j.scitotenv.2021.145536>
- Harris P. T., Westerveld L., Nyberg B., Maes T., Macmillan-Lawler M. and Appelquist L. R. (2021). Exposure of coastal environments to river-sourced plastic pollution. *Science of the Total Environment*, **769**, 145222, <https://doi.org/10.1016/j.scitotenv.2021.145222>
- Hermabessiere L., Dehaut A., Paul-Pont I., Lacroix C., Jezequel R., Soudant P. and Duflos G. (2017). Occurrence and effects of plastic additives on marine environments and organisms: a review. *Chemosphere*, **182**, 781–793.
- Iwalaye O. A., Moodley G. K. and Robertson-Andersson D. V. (2020). Microplastic occurrence in marine invertebrates sampled from Kwazulu-Natal, South Africa in different seasons. *Nature Environment and Pollution Technology, an International Quarterly Scientific Journal*, **19**(5), 1811–1819.
- Jambeck, J. R., Geyer, R., Wilcox, C., Siegler, T. R., Perryman, M., Andrady, A., ... Law, K. L. (2015). Plastic waste inputs from land into the ocean. *Science*, **347**(6223), 768–771.
- Jang, Y. C., Lee, J., Hong, S., Choi, H. W., Shim, W. J. and Hong, S. Y. (2015). Estimating the global inflow and stock of plastic marine debris using material flow analysis: a preliminary approach. *Journal of the Korean Society for Marine Environment & Energy*, **18**(4), 263–273.
- Juan, R., Dominguez, C., Robledo, N., Paredes, B. and Garcia-Munoz, R. A. (2020). Incorporation of recycled high-density polyethylene to polyethylene pipe grade resins to increase close-loop recycling and Underpin the circular economy. *Journal of Cleaner Production*, **276**, 124081.
- Kim J. S., Lee H. J., Kim S. K. and Kim, H. J. (2018). Global pattern of microplastics (MPs) in commercial food-grade salts: sea salt as an indicator of seawater MP pollution. *Environmental Science & Technology*, **52**(21), 12819–12828.
- Klangnurak W. and Chunniyom S. (2002). Screening for microplastics in marine fish of Thailand: the accumulation of microplastics in the gastrointestinal tract of different foraging preferences. *Environmental Science and Pollution Research*, **27**, 27161–27168, <https://doi.org/10.1007/s11356-020-09147-8>
- Lebreton L. M., Greer S. D. and Borrero J. C. (2012). Numerical modelling of floating debris in the world's oceans. *Marine Pollution Bulletin*, **64**(3), 653–661.
- Lebreton L., Slat B., Ferrari F., Sainte-Rose B., Aitken J., Marthouse R., Hajbane S., Cunsolo S., Schwarz A., Levivier A., Noble K., Debeljak P., Maral H., Schoeneich-Argent R., Brambini R. and Reisser J. (2018). Evidence that the Great Pacific Garbage Patch is rapidly accumulating plastic. *Scientific Reports*, **8**, 1–15, <https://doi.org/10.1038/s41598-018-22939-w>
- Lira B. C. S., Cresencia A. C., Tavera M. A. and Janairo J. I. (2020). Volatile chemical profiling and microplastic inspection of fish pastes from Balayan, Batangas, Philippines. *Asian Fisheries Science*, **33**, 213–221.

- Luo Y. Y., Not C. and Cannicci S. (2020). Mangroves as unique but understudied traps for anthropogenic marine debris: a review of present information and the way forward. *Environmental Pollution*, **271**, 116291.
- McGoran A. R., Clark P. F., Smith B. D. and Morritt D. (2020). High prevalence of plastic ingestion by *Eriocheir sinensis* and *Carcinus maenas* (Crustacea: Decapoda: Brachyura) in the Thames Estuary. *Environmental Pollution*, **265**, 114972.
- Messinetti S., Mercurio S., Parolini M., Sugni M. and Pennati R. (2018). Effects of polystyrene microplastics on early stages of two marine invertebrates with different feeding strategies. *Environmental Pollution*, **237**, 1080–1087.
- Moldoveanu S. C. and David V. (2002). Chemical degradation of polymers and pyrolysis. *Journal of Chromatography Library*, **65**, 847–917.
- Muhammad F., Lü Z. M., Liu L., Gong L., Du X., Muhammad Shafi and Kaleri H.A. (2018). Genetic structure of *Octopus minor* around Chinese waters as indicated by nuclear DNA variations (Mollusca, Cephalopoda). *Zookeys*, **17**(775), 1–14. <https://doi.org/10.3897/zookeys.775.24258>.
- Neto H. G., Bantel C. G., Browning J., Della Fina N., Ballabio T. A., de Santana F. T., e Britto M. D. K. and Barbosa C. B. (2021). Mortality of a juvenile Magellanic penguin (*Spheniscus magellanicus*, Spheniscidae) associated with the ingestion of a PFF-2 protective mask during the Covid-19 pandemic. *Marine Pollution Bulletin*, **166**, 112232.
- Neto J. G. B., Rodrigues F. L., Ortega I., Rodrigues L. D. S., Lacerda A. L., Coletto J. L., Kessler F., Cardoso L. G., Madureira L. and Proietti M. C. (2020). Ingestion of plastic debris by commercially important marine fish in southeast-south Brazil. *Environmental Pollution*, **267**, 115508.
- NOAA Fisheries report (2021). 2020 National Report on Large Whale Entanglements. <https://www.fisheries.noaa.gov/resource/document/2020-west-coast-whale-entanglement-summary>
- Parton K. J., Galloway T. S. and Godley B. J. (2019). Global review of shark and ray entanglement in anthropogenic marine debris. *Endangered Species Research*, **39**, 173–190.
- Patria M. P., Santoso C. A. and Tsabita N. (2020). Microplastic ingestion by periwinkle snail *Littoraria scabra* and mangrove crab *Metopograpsus quadridentata* in Pramuka Island, Jakarta Bay, Indonesia. *Sains Malaysiana*, **49**(9), 2151–2158, <https://doi.org/10.17576/jsm-2020-4909-13>
- Pennino M. G., Bachiller E., Lloret-Lloret E., Albo-Puigserver M., Esteban A., Jadaud A., Bellido J. M. and Coll M. (2020). Ingestion of microplastics and occurrence of parasite association in Mediterranean anchovy and sardine. *Marine Pollution Bulletin*, **158**, 111399, <https://doi.org/10.1016/j.marpolbul.2020.111399>
- Phaoduang S., Sutthacheep M., Prakopphon P., Sriwisait P. and Yeemin T. (2021). Abundance and composition of microplastics in dried anchovy products from the Western Gulf of Thailand. *Ramkhamhaeng International Journal of Science and Technology*, **4**(3), 45–51.
- Phothakwanpracha J., Lirdwitayaprasit T. and Pairohakul S. (2021). Effects of sizes and concentrations of different types of microplastics on bioaccumulation and lethality rate in the green mussel, *Perna viridis*. *Marine Pollution Bulletin*, **173**, 112954.
- Rist S., Steensgaard I. M., Guven O., Nielsen T. G., Jensen L. H., Møller L. F. and Hartmann N. B. (2018). The fate of microplastics during uptake and depuration phases in a blue mussel exposure system. *Environmental Toxicology and Chemistry*, **38**(1), 99–105.
- Roman L., Butcher R. G., Stewart D., Hunter S., Jolly M., Kowalski P., ... Lenting, B. (2021). Plastic ingestion is an underestimated cause of death for southern hemisphere albatrosses. *Conservation Letters*, **14**(3), e12785.

- Ryan P. G. (2016). Ingestion of plastics by marine organisms. In: Hazardous chemicals associated with plastics in the marine environment. The Handbook of Environmental Chemistry, Vol. 78. H. Takada and H. Karapanagioti (eds.), Springer, Cham, pp. 235–266.
- Sala B., Balasch A., Eljarrat E. and Cardona L. (2021). First study on the presence of plastic additives in loggerhead sea turtles (*Caretta caretta*) from the Mediterranean Sea. *Environmental Pollution*, **283**, 117108, <https://doi.org/10.1016/j.envpol.2021.117108>
- Schlachter C. B. (2019). Is it time to ban single-use plastic? A look at microplastic in food and water supply.
- Sutthacheep M., Phoaduang S., Chamchoy C., Klinthong W., Salakphet C., Silparasarn A., Sangiamdee D. and Yeemin T. (2021). The particles of microplastics in shrimp paste from the Gulf of Thailand and the Andaman Sea. *Ramkhamhaeng International Journal of Science and Technology*, **4**(1), 27–34.
- Takeshige A., Miyamoto M., Narimatsu Y., Yonezaki S. and Kiyota M. (2021). Evaluation of impacts of bottom fishing on demersal habitats: a case study off the Pacific coast of north-eastern Japan. *Fisheries Research*, **238**, 105916. <https://www.sciencedirect.com/science/article/pii/S0165783621000448?via%3Dihub>, <https://doi.org/10.1016/j.fishres.2021.105916>
- Thomas K., Dr. Dorey C. and Obaidullah F. (2019). Ghost Gear: The Abandoned Fishing Nets Haunting Our Oceans. Greenpeace Germany, Berlin, Germany
- UNEP. (2021). From Pollution to Solution: a global assessment of marine litter and plastic pollution. United Nations Environment Programme, Nairobi, Kenya. <https://www.unep.org/resources/pollution-solution-global-assessment-marine-litter-and-plastic-pollution> (accessed 19 May 2021).
- van Sebille, E. (2016). How much plastic is there in the ocean? <https://www.weforum.org/agenda/2016/01/how-much-plastic-is-there-in-the-ocean/> (accessed 15 May 2021).
- van Franeker, J. A. and Law, K. L. (2015). Seabirds, gyres and global trends in plastic pollution. *Environmental Pollution*, **203**, 89–96.
- van Franeker J. A., Kühn S., Anker-Nilssen T., Edwards E. W., Gallien F., Guse N., Kakkonen J. E., Mallory M. L., Miles W., Olsen K. O. and Pedersen J. (2021). New tools to evaluate plastic ingestion by northern fulmars applied to North Sea monitoring data 2002–2018. *Marine Pollution Bulletin*, **166**, 112246.
- von Moos, N., Burkhardt-Holm, P. and Köhler, A. (2012). Uptake and effects of microplastics on cells and tissue of the blue mussel *Mytilus edulis* L. after an experimental exposure. *Environmental Science & Technology*, **46**(20), 11327–11335.
- Winkler A., Nessi A., Antonioli D., Laus M., Santo N., Parolini M. and Tremolada, P. (2020). Occurrence of microplastics in pellets from the common kingfisher (*Alcedo atthis*) along the Ticino River, North Italy. *Environmental Science and Pollution Research*, **27**(33), 41731–41739, <https://doi.org/10.1007/s11556-020-10163-x>
- Zhang F., Yao C., Xu J., Zhu L., Peng G. and Li D. (2020a). Composition, spatial distribution and sources of plastic litter on the East China Sea floor. *Science of the Total Environment*, **742**, 140525, <https://doi.org/10.1016/j.scitotenv.2020.140525>
- Zhang K., Hamidian A. H., Tubić A., Zhang Y., Fang J. K., Wu C. and Lam P. K. (2020b). Understanding plastic degradation and microplastic formation in the environment: a review. *Environmental Pollution*, **263**(Part A), 116554.
- Zhang K., Hamidian A. H., Tubić A., Zhang Y., Fang J. K., Wu C. and Lam P. K. (2021). Understanding plastic degradation and microplastic formation in the environment: a review. *Environmental Pollution*, **274**, 116554, <https://doi.org/10.1016/j.envpol.2021.116554>

ANNEX 1

ANNEX 3.1 ENTANGLEMENT

Table A3.1.1.1 Cases of entanglement in fishes.

S/N	Entangled Marine Animals	Family	Common Name	Species	Types/Shape of Entanglement	Location	Study Period
1	Cartilaginous fish	Rajidae	Thornback ray	<i>Raja clavata</i>	GFG	Turkey	2016
2	Cartilaginous fish	Rhincodontidae	Whale shark	<i>Rhincodon typus</i>	GFG	Thailand	2017–2018
3	Cartilaginous fish	Rhincodontida	Whale shark	<i>Rhincodon typus</i>	GFG	Thailand	2014–2018
4	Cartilaginous fish	Rhincodontida	Whale shark	<i>Rhincodon typus</i>	GFG	Thailand	2014–2018
5	Cartilaginous fish	Rhincodontida	Whale shark	<i>Rhincodon typus</i>	FAD	Philippines	2019
6	Cartilaginous fish	Rhincodontida	Whale shark	<i>Rhincodon typus</i>	GFG	Philippines	2015–2019
7	Cartilaginous fish	Rhincodontida	Whale shark	<i>Rhincodon typus</i>	GFG	Indonesia	2017–2018
8	Cartilaginous fish	Rhincodontida	Whale shark	<i>Rhincodon typus</i>	GFG	India	2012–2018
9	Cartilaginous fish	Rhincodontida	Whale shark	<i>Rhincodon typus</i>	GFG	India	2013–2018
10	Cartilaginous fish	Rhincodontida	Whale shark	<i>Rhincodon typus</i>	GFG	India	2017–2018
11	Cartilaginous fish	Rhincodontida	Whale shark	<i>Rhincodon typus</i>	GFG	Pakistan	2017–2018
12	Cartilaginous fish	Rhincodontida	Whale shark	<i>Rhincodon typus</i>	GFG	Mozambique	2013–2018
13	Cartilaginous fish	Rhincodontida	Whale shark	<i>Rhincodon typus</i>	GFG	Australia	2013–2018
14	Cartilaginous fish	Rhincodontida	Whale shark	<i>Rhincodon typus</i>	GFG	Mexico	2013–2018
15	Cartilaginous fish	Scyliorhinidae	Lesser spotted dogfish	<i>Scyliorhinus canicula</i>	GFG	UK	2015–2018

(Continued)

Table A3.1.1.1 Cases of entanglement in fishes. (Continued)

S/N	Entangled Marine Animals	Family	Common Name	Species	Types/Shape of Entanglement	Location	Study Period
16	Cartilaginous fish	Scyliorhinidae	Lesser spotted dogfish	<i>Scyliorhinus canicula</i>	GFG	UK	2018–2019
17	Cartilaginous fish	Scyliorhinidae	Lesser spotted dogfish	<i>Scyliorhinus canicula</i>	GFG	France	2018–2019
18	Cartilaginous fish	Scyliorhinidae	Lesser spotted dogfish	<i>Scyliorhinus canicula</i>	OTH	UK	2018–2019
19	Cartilaginous fish	Triakidae	Tope shark	<i>Galeorhinus galeus</i>	GFG	France	2018–2019
20	Cartilaginous fish	Triakidae	Starry smooth-hound	<i>Mustelus asterias</i>	GFG	France	2018–2019
21	Cartilaginous fish	Pristidae	Sawfish sp.	<i>Pristis</i> sp.	GFG	Florida, USA	2011–2019
22	Cartilaginous fish	Odontaspidae	Grey nurse shark	<i>Carcharias taurus</i>	OTH	Australia	2012–2018
23	Cartilaginous fish	Odontaspidae	Grey nurse shark	<i>Carcharias taurus</i>	OTH	Australia	2014–2018
24	Cartilaginous fish	Odontaspidae	Grey nurse shark	<i>Carcharias taurus</i>	GFG	Australia	2014–2018
25	Cartilaginous fish	Mobulidae	Shortfin mako shark	<i>Isurus oxyrinchus</i>	GFG	Australia	2013–18
26	Cartilaginous fish	Mobulidae	Reef manta ray	<i>Mobula alfredi</i>	OTH	Australia	2015–2019 (Continued)

Table A3.1.1 Cases of entanglement in fishes. (Continued)

S/N	Entangled Marine Animals	Family	Common Name	Species	Types/Shape of Entanglement	Location	Study Period
27	Cartilaginous fish	Mobulidae	Oceanic manta ray	<i>Mobula birostris</i>	GFG	Mexico	2018–2019
28	Cartilaginous fish	Mobulidae	<i>Mobula</i> sp.	Manta sp.	GFG	Costa Rica	2015–2019
29	Cartilaginous fish	Mobulidae	<i>Mobula</i> sp.	Manta sp.	GFG	Philippines	2016–2019
30	Cartilaginous fish	Mobulidae	<i>Mobula</i> sp.	Manta sp.	GFG	Australia	2015–2019
31	Cartilaginous fish	Lamnidae	Great white shark	<i>Carcharodon carcharias</i>	OTH	Mexico	2016–2018
32	Cartilaginous fish	Heterodontidae	Port Jackson shark	<i>Heterodontus portusjacksoni</i>	GFG	New South Wales, Australia	2014–2019
33	Cartilaginous fish	Ginglymostomatidae	Nurse shark	<i>Ginglymostoma cirratum</i>	GFG	Florida, USA	2016–2019
34	Cartilaginous fish	Dasyatidae	Common stingray	<i>Dasyatis pastinaca</i>	GFG	France	2018–2019
35	Cartilaginous fish	Cetorhinidae	Basking shark	<i>Cetorhinus maximus</i>	GFG	Rhode Island, USA	2013–2018
36	Cartilaginous fish	Cetorhinidae	Basking shark	<i>Cetorhinus maximus</i>	GFG	Spain	2015–2018
37	Cartilaginous fish	Cetorhinidae	Basking shark	<i>Cetorhinus maximus</i>	GFG	Massachusetts, USA	2015–2018
38	Cartilaginous fish	Carcharhinidae	Blue shark	<i>Prionace glauca</i>	GFG	UK	2015–2–019 (Continued)

Table A3.1.1 Cases of entanglement in fishes. (Continued)

S/N	Entangled Marine Animals	Family	Common Name	Species	Types/Shape of Entanglement	Location	Study Period
39	Cartilaginous fish	Carcharhinidae	Lemon shark	<i>Negaprion brevirostris</i>	GFG	Bahamas	2014–2018
40	Cartilaginous fish	Carcharhinidae	Lemon shark	<i>Negaprion brevirostris</i>	GFG	Florida, USA	2017–2019
41	Cartilaginous fish	Carcharhinidae	Tiger shark	<i>Galeocerdo cuvier</i>	GFG	Hawaii, USA	2016–2018
42	Cartilaginous fish	Carcharhinidae	Tiger shark	<i>Galeocerdo cuvier</i>	GFG	Australia	2016–2018
43	Cartilaginous fish	Carcharhinidae	Spot-tail shark	<i>Carcharhinus sorrah</i>	OTH	Pakistan	2017–2018
44	Cartilaginous fish	Carcharhinidae	Caribbean reef shark	<i>Carcharhinus perezii</i>	GFG	Cayman Islands	2019
45	Cartilaginous fish	Carcharhinidae	Caribbean reef shark	<i>Carcharhinus perezii</i>	GFG	Bahamas	2015–2018
46	Cartilaginous fish	Carcharhinidae	Dusky shark	<i>Carcharhinus obscurus</i>	OTH	Maryland, USA	2014–2018
47	Cartilaginous fish	Carcharhinidae	Oceanic white shark	<i>Carcharhinus longimanus</i>	GFG	Cayman Islands	2018–2019
48	Cartilaginous fish	Carcharhinidae	Oceanic white shark	<i>Carcharhinus longimanus</i>	OTH	Red Sea	2018–2019

(Continued)

Table A3.1.1 Cases of entanglement in fishes. (Continued)

S/N	Entangled Marine Animals	Family	Common Name	Species	Types/Shape of Entanglement	Location	Study Period
49	Cartilaginous fish	Carcharhinidae	Blacktip shark	<i>Carcharhinus limbatus</i>	OTH	South Africa	2013–2018
50	Cartilaginous fish	Carcharhinidae	Blacktip shark	<i>Carcharhinus limbatus</i>	GFG	Florida, USA	2015–2019
51	Cartilaginous fish	Carcharhinidae	Finetooth shark	<i>Carcharhinus isodon</i>	OTH	Florida, USA	2018–2019
52	Cartilaginous fish	Carcharhinidae	Silky shark	<i>Carcharhinus falciformis</i>	GFG	Cayman Islands	2019
53	Cartilaginous fish	Carcharhinidae	Grey reef shark	<i>Carcharhinus amblyrhynchos</i>	GFG	Maldives	2014–2019
54	Cartilaginous fish	Alopiidae	Pelagic thresher shark	<i>Alopias pelagicus</i>	GFG	Philippines	2019

Note: GFG = ghost fishing gear, ML = monofilament line, FAD = fish aggregating device, PSB = polypropylene strapping bands, OTH = other entangling materials.

Source: Capapé *et al.* (2018) and Parton *et al.* (2019).

Table A3.1.2 Demersal organisms collected by the trawl survey between 2006 and 2014, off the Pacific coast of north-eastern Japan.

S/N	Entangled Marine Animals	Family	Common Name	Species	Types/Shape of Entanglement	Location	Study Period
1	Molluscs (Cephalopods)	Ommastrephidae	Japanese flying squid	<i>Todarodes pacificus</i>	Fishing gear	North-eastern Japan	2006–2014
2	Molluscs (Cephalopods)	Loliginidae	Spear squid	<i>Loligo bleekeri</i>	Fishing gear	North-eastern Japan	2006–2014
3	Arthropods (Crustacean)	Oregoniidae	Snowcrab	<i>Chionoecetes opilio</i>	Fishing gear	North-eastern Japan	2006–2014
4	Arthropods (Crustacean)	Oregoniidae	Red snow crab	<i>Chionoecetes japonicus</i>	Fishing gear	North-eastern Japan	2006–2014
5	Demersal fish	Pleuronectidae	Flathead flounder	<i>Hippoglossoides dubius</i>	Fishing gear	North-eastern Japan	2006–2014
6	Demersal fish	Pleuronectidae	Kamchatka flounder	<i>Atheresthes evermanni</i>	Fishing gear	North-eastern Japan	2006–2014
7	Demersal fish	Moridae	Threadfin hake	<i>Laemonema longipes</i>	Fishing gear	North-eastern Japan	2006–2014
8	Demersal fish	Moridae	Japanese codling	<i>Physiculus maximowiczi</i>	Fishing gear	North-eastern Japan	2006–2014
9	Demersal fish	Sebastidae	Broadbanded thornyhead	<i>Sebastes macrochir</i>	Fishing gear	North-eastern Japan	2006–2014
10	Demersal fish	Gadidae	Walleye pollock	<i>Gadus chalcogrammus</i>	Fishing gear	North-eastern Japan	2006–2014
11	Demersal fish	Pleuronectidae	Slime flounder	<i>Microstomus achne</i>	Fishing gear	North-eastern Japan	2006–2014

(Continued)

Table A3.1.1.2 Demersal organisms collected by the trawl survey between 2006 and 2014, off the Pacific coast of north-eastern Japan.
(Continued)

S/N	Entangled Marine Animals	Family	Common Name	Species	Types/Shape of Entanglement	Location	Study Period
12	Demersal fish	Gadidae	Pacific cod	<i>Gadus macrocephalus</i>	Fishing gear	North-eastern Japan	2006–2014
13	Demersal fish	Chlorophthalmidae	Shortnose greeneye	<i>Chlorophthalmus borealis</i>	Fishing gear	North-eastern Japan	2006–2014
14	Molluscs (Cephalopods)	Goniatidae	Schoolmaster gonate squid	<i>Berryteuthis magister</i>	Fishing gear	North-eastern Japan	2006–2014
15	Molluscs (Cephalopods)	Enteractopodidae	North Pacific giant octopus	<i>Paroctopus dofleini</i>	Fishing gear	North-eastern Japan	2006–2014
16	Molluscs (Cephalopods)	Octopodidae	Chestnut octopus	<i>Paroctopus conispadiceus</i>	Fishing gear	North-eastern Japan	2006–2014
17	Arthropods (Crustacean)	Cheiragonidae	Horse crab	<i>Erimacrus isenbeckii</i>	Fishing gear	North-eastern Japan	2006–2014
18	Arthropods (Crustacean)	Pandalidae	Higoromo shrimp	<i>Pandalopsis coccinata</i>	Fishing gear	North-eastern Japan	2006–2014
19	Arthropods (Crustacean)	Pandalidae	Botan shrimp	<i>Pandalus nipponensis</i>	Fishing gear	North-eastern Japan	2006–2014
20	Arthropods (Crustacean)	Pandalidae	Alaskan pink shrimp	<i>Pandalus eous</i>	Fishing gear	North-eastern Japan	2006–2014

Note: Numbers of hard corals by genus around Koh Tao (with growth forms encountered) growing underneath (Un), adjacent to (Ad), and on the gear (On).
Sources: [Takeshige et al. \(2021\)](#).

Table A3.1.3 Case of entangled marine birds and mammals (1997–2017) in California, USA.

S/N	Entangled Marine Animals	Family	Common Name	Species/Total Entangled	Types/Shape of Entanglement	Location	Study Period
1	Marine bird	Alcidae https://en.wikipedia.org/wiki/Auk	Common Murre	<i>Uria aalge</i> (84)	ML, FAD	California, USA	1997–2017
2	Marine bird	Alcidae	Rhinoceros auklet	<i>Cerorhinca monocerata</i> (1)	ML	California, USA	1997–2017
3	Marine bird	Alcidae	Pigeon guillemot	<i>Cepphus Columbia</i> (2)	ML	California, USA	1997–2017
4	Marine bird	Phalacrocoracidae	Brandt's cormorant	<i>Phalacrocorax penicillatus</i> (47)	ML	California, USA	1997–2017
5	Marine bird	Phalacrocoracidae	The double-crested cormorant	<i>Phalacrocorax auritus</i> (4)	ML	California, USA	1997–2017
6	Marine bird	Phalacrocoracidae	Pelagic cormorant	<i>Phalacrocorax pelagicus</i> (5)	ML	California, USA	1997–2017
7	Marine bird	Phalacrocoracidae	Cormorant	Unidentified (9)	ML	California, USA	1997–2017
8	Marine bird	Pelecanidae	Brown pelican	<i>Pelecanus occidentalis</i> (24)	ML, FAD	California, USA	1997–2017
9	Marine bird	Anatidae	Surf scoter	<i>Melanitta perspicillata</i> (7)	MF	California, USA	1997–2017
10	Marine bird	Anatidae	Scoter	Unidentified (1)	MF	California, USA	1997–2017
11	Marine bird	Anatidae	Red-breasted merganser	<i>Mergus serrator</i> (1)	MF	California, USA	1997–2017

(Continued)

Table A3.1.3 Case of entangled marine birds and mammals (1997–2017) in California, USA. (Continued)

S/N	Entangled Marine Animals	Family	Common Name	Species/Total Entangled	Types/Shape of Entanglement	Location	Study Period
12	Marine bird	Scolopacidae	The willet	<i>Tringa semipalmata</i> (2)	MF	California, USA	1997–2017
13	Marine bird	Unidentified	Shorebird	Unidentified (2)	MF	California, USA	1997–2017
14	Marine bird	Podicipedidae	Western grebe	<i>Aechmophorus occidentalis</i> (15)	MF	California, USA	1997–2017
15	Marine bird	Podicipedidae	Western grebe	<i>Aechmophorus</i> spp. (9)	MF	California, USA	1997–2017
16	Marine bird	Podicipedidae	Clark's grebe	<i>Aechmophorus clarkia</i> (1)	MF	California, USA	1997–2017
17	Marine bird	Podicipedidae	Grebe	Unidentified (2)	MF	California, USA	1997–2017
18	Marine bird	Laridae	California gull	<i>Larus californicus</i> (11)	MF	California, USA	1997–2017
19	Marine bird	Laridae	Heermann's gull	<i>Larus heermanni</i> (7)	MF	California, USA	1997–2017
20	Marine bird	Laridae	Glaucous-winged gull	<i>Larus glaucescens</i> (5)	MF	California, USA	1997–2017
21	Marine bird	Laridae	Ring-billed gull	<i>Larus delawarensis</i> (1)	MF	California, USA	1997–2017

(Continued)

Table A3.1.3 Case of entangled marine birds and mammals (1997–2017) in California, USA. (Continued)

S/N	Entangled Marine Animals	Family	Common Name	Species/Total Entangled	Types/Shape of Entanglement	Location	Study Period
22	Marine bird	Laridae	Thayer's gull	<i>Larus thayeri</i> (1)	MF	California, USA	1997–2017
23	Marine bird	Laridae	Western gull	<i>Larus occidentalis</i> (34)	MF, FAD	California, USA	1997–2017
24	Marine bird	Laridae	Gull	Unidentified (19)	MF, FAD	California, USA	1997–2017
25	Marine bird	Laridae	Elegant tern	<i>Thalasseus elegans</i> (1)	MF	California, USA	1997–2017
26	Marine bird	Gaviidae	Common loon	<i>Gavia immer</i> (1)	MF	California, USA	1997–2017
27	Marine bird	Gaviidae	Common loon	<i>Gavia pacifica</i> (8)	MF	California, USA	1997–2017
28	Marine bird	Gaviidae	Loon	Unidentified (1)	MF	California, USA	1997–2017
29	Marine bird	Diomedidae	Black-footed albatross	<i>Phoebastria nigripes</i> (2)	MF	California, USA	1997–2017
30	Marine bird	Procellariidae	Northern fulmar	<i>Fulmarus glacialis</i> (4)	MF	California, USA	1997–2017

(Continued)

Table A3.1.3 Case of entangled marine birds and mammals (1997–2017) in California, USA. (Continued)

S/N	Entangled Marine Animals	Family	Common Name	Species/Total Entangled	Types/Shape of Entanglement	Location	Study Period
31	Marine bird	Procellariidae	Black-vented shearwater	<i>Puffinus opisthomelas</i> (1)	MF	California, USA	1997–2017
32	Marine bird	Procellariidae	The black-vented shearwater	<i>Ardenna grisea</i> (28)	MF	California, USA	1997–2017
33	Marine bird	Procellariidae	Shearwater	Unidentified (5)	MF	California, USA	1997–2017
34	Marine mammal	Otariidae	California sea lion	<i>Zalophus californianus</i> (7)	MF	California, USA	1997–2017
35	Marine mammal	Phocidae	Harbour seal	<i>Phoca vitulina</i>	MF	California, USA	1997–2017
36	Marine mammal	Delphinidae	Long-beaked common dolphin	<i>Delphinus capensis</i>	MF	California, USA	1997–2017

Note: GFG = ghost fishing gear, ML = monofilament line, FAD = fish aggregating device, PSB = polypropylene strapping bands, OTH = other entangling materials.

Sources: Donnelly-Greenan et al. (2019).

ANNEX 3.2 INGESTION

Table A3.2.1 Microplastics in target organs in echinoderm, molluscs and coral reefs.

S/N	Phylum/ Class	List of Ingested Gested MA	Family	Common Name	Species	Type of IP	Shape of IP
1	Echinoderms	Sea Cucumber	Holothuriidae	Sea Cucumber	Holothuria cinerascens	Microbead	Fragments Fibres Film
2	Echinoderms	Sea Cucumber	Stichopodidae	Japanese sea cucumber	Apostichopus japonicus	Cellophane Polyester, PET	Fibres
3	Echinoderms	Sea Urchin	Parechinidae	Common Sea Urchin	<i>Paracentrotus lividus</i>	PS	N/A
4	Mammal	Sea cow	Dugongidae	Sea cow	Dugong	N/A	N/A
5	Echinoderms	Sea cucumber	Cucumariidae	Trepang	Holothuria cinerascens	PE	Frag-ments Fibres
6	Echinoderms	Sea cucumber	Cucumariidae	Trepang	<i>Strombidium sulcatum</i>	PS	Microbeads

Note: MA = marine animals, IP = ingested plastics.

Colour	Number of Plastics Bioaccumulated	Target Organ	Size	Location	Study Period	References
Pink Black Blue Yellow White	0.1-1	N/A	N/A	Kwazulu-Natal South Africa	Summer/ Winter July 2017- Feb 2018	Iwalaye et al. (2020)
N/A	0-30	Intestines	55 μm	Bohai Sea Yellow Sea in China	2018	Muhammad et al. (2018)
Red	N/A	Presumably Intestines (found in faecal pellet)	10-30 μm	Italy	2018	Messinetti et al. (2018)
N/A	N/A	Stomach	N/A	South Thailand	May 2019	Emily Dixon (2019)
Fluorescent	32-227	N/A	0.59 to 2.90 μm	South Africa	2018	Iwalaye et al. (2020)
Fluorescent	32-227	N/A	0.5-5 μm	South Africa	2018	Iwalaye et al. (2020)

Table A3.2.2 Nanoplastics in target organ in echinoderms, molluscs and coral reefs.

S/N	Class	List of Ingested MA	Family	Common Name	Species	Type of IP	Shape of IP	Colour	Number of Plastics Bioaccumulated	Target Organ	Size (mm)	Location	Study Period	References
1	Molluscs	Blue mussel	Mytilidae	Common mussel	<i>Mytilus edulis</i>	PS	Beads	Fluorescent	N/A	N/A	2 µm–100 nm	The island of Skafthö, Sweden	2018	Rist <i>et al.</i> (2018)
2	Molluscs	Blue mussel larvae	Mytilidae	Common mussel	<i>Rhodomonas salina</i>	PS	Beads	Fluorescent	N/A	N/A	2 µm–100 nm	Denmark	2018	Rist <i>et al.</i> (2018)

Note: IP = ingested plastics, MA = marine animals.

Table A3.2.3 Nanoplastics ingestion by blue mussels, sea cucumber, shrimp and red mullet.

S/N	List of Ingested MA	Family	Common Name	Species	Type of IP	Shape of IP	Colour	Number of Plastics Bioaccumulated	Size	Location	Study Period	References
1.	Blue mussel	Mytilidae	Common mussel	<i>Mytilus edulis</i>	PS	Beads	Fluorescent	N/A	2 µm 100 nm	The island of Skafnö, Sweden	2018	Rist <i>et al.</i> (2018)
2	Blue mussel larvae	Mytilidae	Common mussel	<i>Rhodomonas salina</i>	PS	Beads	Fluorescent	N/A	2 µm 100 nm	Limfjorden near Sallingsund (Denmark)	2018	Rist <i>et al.</i> (2018)
3	Sea cucumber	Holothuriidae	Ashy sea cucumber	<i>Holothuria cinerascens</i>	PS	Fibres	Fluorescent	N/A	0.59– 2.90 µm	Limfjorden near Sallingsund (Denmark)	2018	Rist <i>et al.</i> (2018)
4	Francisco brine shrimp	Artemiidae	San Francisco brine shrimp	<i>Artemia franciscana</i>	PS	Fibres	Fluorescent	N/A	N/A	Spain	2016	Rist <i>et al.</i> (2018)
5	Red mullet	Carcharhinidae	Requiem sharks	<i>Mullus barbatus barbatus</i> , <i>Trigla lyra</i>	N/A	Fibres	Fluorescent	3	N/A	Southern Tyrrhenian Sea	June 2017	Rist <i>et al.</i> (2018)
6	Piper gurnard	Carcharhinidae	Requiem sharks	<i>Trigla lyra</i>	N/A	Fibres	Fluorescent	4	N/A	Southern Tyrrhenian Sea	June 2017	Rist <i>et al.</i> (2018)
7	Blackmouth cat shark	Carcharhinidae	Requiem sharks	Catshark <i>Galeus melastomus</i>	N/A	Fibres	Fluorescent	6	N/A	Southern Tyrrhenian Sea	June 2017	Rist <i>et al.</i> (2018)
8	Lesser spotted dogfish	Scyliorhinidae	Catshark	<i>Scyliorhinus canicula</i>	N/A	Fibres	Fluorescent	4	N/A	Southern Tyrrhenian Sea	June 2017	Rist <i>et al.</i> (2018)
9	Brown ray	Rajidae	Brown ray	<i>Raja miraletus</i>	N/A	Fibres	Fluorescent	1	N/A	Southern Tyrrhenian Sea	June 2017	Rist <i>et al.</i> (2018)

Note: IP = ingested plastics, MA = marine animals.

Table A3.2.4 Microplastics ingestion by marine animals.

S/N	List of Ingested MA	Family	Common Name	Species	Type of IP	Shape of IP	Colour	Number of Plastics Bioaccumulated	Size	Location	Study Period	References
1	Sea cucumber	Cucumariidae	Trepang	<i>Holothuria cinerascens</i>	PE	Fragments fibres	Fluorescent	32-227 (fibres)	0.59 to 2.90 μm	South Africa	2018	Iwalaye <i>et al.</i> (2020)
2	Sea cucumber	Cucumariidae	Trepang	<i>Strombidium sulcatum</i>	PS	Microbeads	Fluorescent	32-227 (fibres)	0.5-5 μm	South Africa	2018	Iwalaye <i>et al.</i> (2020)
3	Wild Clupeiforme fishes.	Clupeidae	Anchovies	<i>Engraulis encrasicolus</i>	PE	N/A	N/A	N/A	323 μm	Mediterranean Sea	2013-2017	Collard <i>et al.</i> (2017)
4	Blue sharks	Carcharhinidae	Requiem sharks	<i>Prionace glauca</i>	PE	Fragments	N/A	N/A	<5 mm	Mediterranean Sea	1999-2015	Bernardini <i>et al.</i> (2018)
5	Blue sharks	Carcharhinidae	Requiem sharks	<i>Sardina pilchardus</i>	PE	Fragments	Black blue multicolour	N/A	5.27-1310 μm	Mediterranean Sea	1999-2015	Capillo <i>et al.</i> (2020)
6	Red mullet	Carcharhinidae	Requiem sharks	<i>Mullus barbatus barbatus</i> ,	PP, PTFE, CA, PA, Kraton G and PE	Fibres	Black	21	N/A	Southern Tyrrhenian Sea	June 2017	Capillo <i>et al.</i> (2020)
7	Piper gurnard	Carcharhinidae	Requiem sharks	<i>Trigla lya</i>	Cellulose	Fibres	Black	75	N/A	Tyrrhenian Sea	June 2017	Capillo <i>et al.</i> (2020)
8	Blackmouth cat shark	Carcharhinidae	Requiem sharks	<i>Galeus melastomus</i>	PP, PTFE, CA, PA, and PE	Fibres	Black	12	N/A	Tyrrhenian Sea	June 2017	Capillo <i>et al.</i> (2020)
9	Lesser spotted dogfish	Catshark	Scyliorhinidae	<i>Scyliorhinus canicula</i>	PP, PTFE, and PE	Fibres	Black	1	N/A	Tyrrhenian Sea	June 2017	Capillo <i>et al.</i> (2020)
10	Brown ray	Rajidae	Brown ray	<i>Raja miraletus</i>	PP, PTFE, CA, PA, Kraton G and PE	Fibres	Black	N/A	N/A	Tyrrhenian Sea	June 2017	Capillo <i>et al.</i> (2020)

Note: IP = ingested plastics, MA = marine animals.

Table A 3.2.5 Macroplastics ingestion by marine animals.

S/N	List of Ingested MA	Family	Common Name	Species	Type of IP	Shape of IP	Color	Number of Plastics Bioaccumulated	Size (mm)	Location	Study Period	References
1	Blue sharks	Carcharhinidae	Requiem sharks	<i>Prionace glauca</i>	PE PS PP	Fragments	N/A	N/A	>25 mm	Mediterranean Sea	1999–2015	Bernardini <i>et al.</i> (2018)
2	Blue sharks	Carcharhinidae	Requiem sharks	<i>S. pilchardus</i>	PE PS PP	Fragments	N/A	N/A	>25 mm	Mediterranean Sea	1999–2015	Bernardini <i>et al.</i> (2018)
3	Blue sharks	Carcharhinidae	Requiem sharks	<i>E. encrasicolus</i>	PE PS PP	Fragments	N/A	N/A	>25 mm	Mediterranean Sea	1999–2015	Bernardini <i>et al.</i> (2018)
4	Blue sharks	Carcharhinidae	Requiem sharks	<i>Galeus melastomus</i>	PE PS	Fragments	N/A	N/A	>25 mm	Mediterranean Sea	1999–2015	Bernardini <i>et al.</i> (2018)
5	Blue sharks	Carcharhinidae	Requiem sharks	<i>Scyliorhinus canicula</i>	PE PS PP	Fragments	N/A	N/A	>25 mm	Mediterranean Sea	1999–2015	Bernardini <i>et al.</i> (2018)

Note: IP = ingested plastics, MA = marine animals.

Table A 3.2.6 MP ingestion.

S/N	List of ingested MA	Family	Common Name	Species	Type of IP	Shape of IP	Colour	Size (mm)	Location	Study Period	References
1	Pelagic fish	Scombridae	Pelagic skipjack tuna	<i>Katsuwonus pelamis</i>	Polyamide Polyurethane	Fibres fragments	Transparent blue black	0.001	Southeast Brazil	2016–2018	Neto <i>et al.</i> (2020)
2	Demersal bluewing scarobin	<i>Prionotus punctatus</i>	Demersal	Triglidae	Polyamide polyurethane	Fibres fragments	Transparent blue black	0.001	Southeast Brazil	2016–2018	Neto <i>et al.</i> (2020)
3	Tube-nosed seabird	Albatrosses	Sea birds	Genera <i>Diomedea</i> , <i>Thalassarche</i>	N/A	N/A	N/A	0.001	New Zealand Australia	2013–2017	Roman <i>et al.</i> (2020)
4	Shearwater	Buller's Albatross	Sea birds	<i>Thalassarche</i>	N/A	N/A	N/A	0.001	New Zealand Australia	2013–2017	Roman <i>et al.</i> (2020)
5	Birds	Albatross	Sea birds	<i>Phoebastria</i>	N/A	N/A	N/A	0.001	New Zealand Australia	2013–2017	Roman <i>et al.</i> (2020)
6	Sand-bubbler crab	Ocyropodidae	Crab	<i>Dotilla fenestrata</i>	Microbead	Fragments Fibres Film	Pink Black Blue Yellow White	0.1–1	Kwazulu-Natal South Africa	Summer/Winter July 2017–Feb 2018	Iwalye <i>et al.</i> (2020)
7	Sea cucumber	Holothuriidae	Sea cucumber	<i>Holothuria cinerascens</i>	Microbead	Fragments Fibres Film	Pink Black Blue Yellow White	0.1–1	Kwazulu-Natal South Africa	Summer/Winter July 2017–Feb 2018	Iwalye <i>et al.</i> (2020)
8	Sea squirt	Pyuridae	Red bait	<i>Pyura stolonifera</i>	Microbead	Fragments Fibres Film	Pink Black Blue Yellow White	0.1–1	Kwazulu-Natal South Africa	Summer/Winter July 2017–Feb 2018	Iwalye <i>et al.</i> (2020)
9	Bird	Alcedinidae	Kingfisher	<i>Alcedo Atthis</i>	Polyurethane PE PP	Fragments Fibres	N/A	0.003–0.04	Ticino River, North Italy	March–October 2019	Winkler (2020)

(Continued)

Table A 3.2.6 MP ingestion. (Continued)

S/N	List of Ingested MA	Family	Common Name	Species	Type of IP	Shape of IP	Colour	Size (mm)	Location	Study Period	References
10	Brachyuran crab	Portunidae	Littoral crab	<i>Carcinus maenas</i>	N/A	Fibre Film Fragment	Black Clear	0.034	Thames Estuary	December 2018 and October 2019	McGoran <i>et al.</i> (2020)
11	Invasive Chinese mitten crab	Varunidae	Crab	<i>Eriocheir sinensis</i>	N/A	Fibre Film Fragment	Black Clear	0.034	Thames Estuary	December 2018 and October 2019	McGoran <i>et al.</i> (2020)
12	European sardine	Clupeidae	Fish	<i>Sardina pilchardus</i>	N/A	Fibre	N/A	< 5	Northwestern Mediterranean Sea	April–June 2018	Pemino <i>et al.</i> (2020)
13	European anchovy	Anchovy	Fish	<i>Engraulis encrasicolus</i>	N/A	Fibres	N/A	< 5	Northwestern Mediterranean Sea	April–June 2018	Pemino <i>et al.</i> (2020)
14	Prey Birds	Accipitridae	Red-shouldered Hawk	<i>Buteo lineatus</i>	PET Rayon	Fibres Fragments Microbeads	Clear Royal blue	< 5	Central Florida, USA	January to May 2018	Carlin <i>et al.</i> (2020)
15	Prey Birds	Pandionidae	Osprey	<i>Pandion haliaetus</i>	PET PE PP	Fibre Fragment Microbead,	Blue White Red Yellow Black Brown Green	< 5	Central Florida, USA	January to May 2018	Carlin <i>et al.</i> (2020)
16	Mangrove periwinkle snail	Littorinidae	Snail	<i>Littoraria scabra</i>	N/A	Fibre Film Fragment	N/A	< 5	Pramuka Island, Jakarta Bay, Indonesia	April 14, 2018	Patria <i>et al.</i> (2020)
17	Mangrove Crab	Grapsidae	Crab	<i>Metopograpsus quadridentata</i>	N/A	Fibre Film Fragment Granula	N/A	< 5	Pramuka Island, Jakarta Bay, Indonesia	April 14, 2018	Patria <i>et al.</i> (2020)

(Continued)

Table A.3.2.6 MP ingestion. (Continued)

S/N	List of Ingested MA	Family	Common Name	Species	Type of IP	Shape of IP	Colour	Size (mm)	Location	Study Period	References
18	Post-hatchling loggerhead	Modern sea turtles	Sea turtles	<i>Caretta caretta</i>	N/A	Fragments	N/A	0.36–5	Northeast Florida	2017	Eastman <i>et al.</i> (2020)
19	Fish	Loricariidae	Fish	<i>Hypostomus ancistroides</i>	N/A	Fibres	Yellow Blue	1.00	Southern Brazil	May 2018	
20	Fish	Loricariidae	Cat Fish	<i>Hypostomus cf. strigaticeps</i>	N/A	Fibres	Yellow Blue	1.00	Southern Brazil	May 2018	
21	Fish	Guppy	Livebearer	<i>Poecilia reticulata</i>	N/A	Fibres	Yellow Blue	1.00	Southern Brazil	May 2018	
22	Scottish haddock	Gadidae	Haddock	<i>Melanogrammus aeglefinus</i>	PE	Fibres	N/A	<5	United Kingdom	2016	Akousson <i>et al.</i> (2020)
23	Greek seabass	Moromidae	European seabass	<i>Dicentrarchus labrax</i>	PE	Fibres	N/A	<5	United Kingdom	2016	Akousson <i>et al.</i> (2020)
24	Icelandic plaice	European plaice	Dabs	<i>Pleuronectes platessa</i>	PE	Fibres	N/A	<5	United Kingdom	2016	Akousson <i>et al.</i> (2020)
25	Atlantic mackerel	Scombridae	Atlantic mackerel	<i>Scomber scombrus</i>	P PE	Fibres	N/A	<5	United Kingdom	2016	Akousson <i>et al.</i> (2020)
26	Patagonian scallop	Pectinidae	Bivalve seashells	<i>Zygochlamys patagonica</i>	PE	Fibres	N/A	<5	United Kingdom	2016	Akousson <i>et al.</i> (2020)
27	Scottish scallop	Scallops	Great scallop	<i>Pecten maximus</i>	PE	Fibres	N/A	<5	United Kingdom	2016	Akousson <i>et al.</i> (2020)
28	Pelagic fish	Marine pelagic fish	Oceanic fish	Scombridae Clupeidae	Polyamide	Fibres	Red	0.5	Gulf of Thailand & Andaman Sea	June 2018–Feb 2019	Kiangnuraak and Chunniyom (2020)
29.	Pelagic fish	Marine pelagic fish	Oceanic fish	Caesionidae	Polyamide	Fibres	Red	0.5	Gulf of Thailand &	June 2018–Feb 2019	Kiangnuraak and Chunniyom (2020)

(Continued)

Table A 3.2.6 MP ingestion. (Continued)

S/N	List of ingested MA	Family	Common Name	Species	Type of IP	Shape of IP	Colour	Size (mm)	Location	Study Period	References
30	Pelagic fish	Marine pelagic fish	Oceanic fish	Carangidae	Polyamide	Fibres	Red	0.5	Andaman Sea	June 2018–Feb 2019	Klangnuraak and Chunnuiyom (2020)
31	Demersal Fish	Benthopelagic	Groundfish	Leiognathidae	Polyamide	Fibres	Red	0.5	Gulf of Thailand &	June 2018–Feb 2019	Klangnuraak and Chunnuiyom (2020)
32	Demersal Fish	Benthopelagic	Groundfish	Synodontidae	Polyamide	Fibres	Red	0.5	Andaman Sea	June 2018–Feb 2019	Klangnuraak and Chunnuiyom (2020)
33	Demersal Fish	Benthopelagic	Groundfish	Platycephalidae	Polyamide	Fibres	Red	0.5	Gulf of Thailand &	June 2018–Feb 2019	Klangnuraak and Chunnuiyom (2020)
34	Demersal Fish	Benthopelagic	Groundfish	Mulidae	Polyamide	Fibres	Red	0.5	Andaman Sea	June 2018–Feb 2019	Klangnuraak and Chunnuiyom (2020)
35	Demersal Fish	Benthopelagic	Groundfish	Terapontidae	Polyamide	Fibres	Red	0.5	Gulf of Thailand &	June 2018–Feb 2019	Klangnuraak and Chunnuiyom (2020)
36	Demersal Fish	Benthopelagic	Groundfish	Nemipteridae	Polyamide	Fibres	Red	0.5	Andaman Sea	June 2018–Feb 2019	Klangnuraak and Chunnuiyom (2020)
37	Demersal Fish	Benthopelagic	Groundfish	Siganidae	Polyamide	Fibres	Red	0.5	Gulf of Thailand &	June 2018–Feb 2019	Klangnuraak and Chunnuiyom (2020)

Note: IP = ingested plastics, MA = marine animals.

Table A 3.2.7 Macroplastics ingestion by marine animals.

S/N	List of Ingested MA	Family	Common Name	Species	Type	Shape of IP	Colour	Size (mm)	Location	Study Period	References
1	Sea birds	Albatrosses	Albatross	Genera <i>Diomedea</i> ,	N/A	N/A	N/A	>25	New Zealand	2013–2017	Roman <i>et al.</i> (2020)
2	Invasive Chinese mitten crab	Varunidae	Crab	<i>Eriocheir sinensis</i>	N/A	Fibre Film Fragment	Black	34	Thames Estuary	December 2018 and October 2019	McGoran <i>et al.</i> (2020)
3	Brachyuran crab	Portunidae	<i>European green crab</i>	<i>Carcinus maenas</i>	N/A	Fibre Film Fragment	Clear	34	Thames Estuary	December 2018 and October 2019	McGoran <i>et al.</i> (2020)
4	Prey birds	Cathartidae	Black vulture	<i>Coragyps atratus</i>	PET PE PP	Fragments	Blue Clear Red Yellow	>25	Central Florida, USA	January to May 2018	Carlin <i>et al.</i> (2020)
5	Post-hatchling loggerhead	Cheloniidae	Sea turtles	<i>C. mydas</i>	N/A	Fragments	N/A	45.92–76.35	North Florida	2017	Eastman <i>et al.</i> (2020)

Note: IP = ingested plastics, MA = marine animals.

Table A 3.2.8 Impacts of plastic ingestion by marine animals.

List of Ingested Marine Animals	Family	Common Name	Species	Type Shape of Ingested Plastics	Location	Study Period	References
Freshwater turtle	Emyidae	Turtle	<i>A. marmorata</i>	MP	Los Angeles, USA	2011–2021	Clause <i>et al.</i> (2021)
Whale	Balaenopteridae	Bryde Whale	N/A	MP	western Mediterranean	2021	Sala <i>et al.</i> (2021)
Loggerhead turtles	Cheloniidae	Turtle	<i>Caretta caretta</i>	MP	Western Mediterranean	2021	Sala <i>et al.</i> (2021)
Jellyfish	Ulmaridae	Fish	Scyphozoa	MP	western Mediterranean	2021	Sala <i>et al.</i> (2021)
Teleost fishes	N/A	Fish	Teleostei	MP	western Mediterranean	2021	Sala <i>et al.</i> (2021)
Sea birds	Gulls	Gull	<i>Larus</i> genus	MP (<5 mm)	Lima, Peru	September 2020–March 2021	De-la-Torre <i>et al.</i> (2021)
Sea birds	Pelecanidae Rafinesque	Brown Pelican	Peruvian pelicans	MP (<5 mm)	Lima, Peru	September 2020–March 2021	De-la-Torre <i>et al.</i> (2021)
Sea birds	Laridae	Inca terns	<i>Larosterna inca</i>	MP (<5 mm)	Lima, Peru	September 2020–March 2021	De-la-Torre <i>et al.</i> (2021)

(Continued)

Table A 3.2.8 Impacts of plastic ingestion by marine animals. (Continued)

List of Ingested Marine Animals	Family	Common Name	Species	Type Shape of Ingested Plastics	Location	Study Period	References
Sea birds	Guanay cormorants	Bougainvillea	<i>Leucocarbo bougainvillii</i>	MP (<5 mm)	Lima, Peru	September 2020–March 2021	De-la-Torre <i>et al.</i> (2021)
Arctic seabird	Procellariidae	Sea bird	Fulmar Guano	MP (fibres)	Qikiqtani Canadian Arctic	10–12 August 2018	Hamilton <i>et al.</i> (2021)
Juvenile Magellanic penguin	Penguins	Penguin	<i>Spheniscus magellanicus</i>	Macroplastics (protective face mask)	São Sebastião, Brazil	9 September 2020	Gallo Netto <i>et al.</i> (2021)
Sea birds	Procellariidae	Fulmar	<i>Fulmarus glacialis</i>	N/A	Canadian Arctic	2002–2018	van Franeker <i>et al.</i> (2021)
Marine fish	<i>Acanthuridae</i>	Coral reef fish	<i>Cantharus dussumieri</i>	MP (<5 mm) Fibres	Southern Taiwan	May 2017–March 2018	Chen <i>et al.</i> (2021)
Marine fish	<i>Acanthuridae</i>	Coral reef fish	<i>Acanthurus triostegus</i>	MP (<5 mm) Fibres	Southern Taiwan	May 2017–March 2018	Chen <i>et al.</i> (2021)
Marine fish	<i>Acanthuridae</i>	Coral reef fish	<i>Acanthurus mata</i>	MP (<5 mm) Fibres	Southern Taiwan	May 2017–March 2018	Chen <i>et al.</i> (2021)
Marine fish	<i>Apogonidae</i>	Coral reef fish	<i>Ostorhinchus aureus</i>	MP (<5 mm) Fibres	Southern Taiwan	May 2017–March 2018	Chen <i>et al.</i> (2021)

(Continued)

Table A 3.2.8 Impacts of plastic ingestion by marine animals. (Continued)

List of Ingested Marine Animals	Family	Common Name	Species	Type Shape of Ingested Plastics	Location	Study Period	References
Marine fish	<i>Apogonidae</i>	Coral reef fish	<i>Ostorhinchus cookii</i>	pogonidae	<i>Apogonidae</i>		
	MP (<5 mm) Fibres	Southern Taiwan	May 2017–March 2018	Chen <i>et al.</i> (2021)			
Marine fish	<i>Balistidae</i>	Coral reef fish	<i>Sufflamen chrysopteron</i>	MP (<5 mm) Fibres	Southern Taiwan	May 2017–March 2018	Chen <i>et al.</i> (2021)
Marine fish	<i>Carangidae</i>	Coral reef fish	<i>Scomberoides lysan</i>	MP (<5 mm) Fibres	Southern Taiwan	May 2017–March 2018	Chen <i>et al.</i> (2021)
Marine fish	<i>Cirrhitidae</i>	Coral reef fish	<i>Paracirrhites forsteri</i>	MP (<5 mm) Fibres	Southern Taiwan	May 2017–March 2018	Chen <i>et al.</i> (2021)
Marine fish	<i>Cirrhitidae</i>	Coral reef fish	<i>Cirrhitis pinnulatus</i>	MP (<5 mm) Fibres	Southern Taiwan	May 2017–March 2018	Chen <i>et al.</i> (2021)
Marine fish	<i>Kyphosidae</i>	Coral reef fish	<i>Kyphosus cinerascens</i>	MP (<5 mm) Fibres	Southern Taiwan	May 2017–March 2018	Chen <i>et al.</i> (2021)
Marine fish	<i>Iniistius melanopus Labridae</i>	Coral reef fish	<i>Iniistius melanopus</i>	MP (<5 mm) Fibres	Southern Taiwan	May 2017–March 2018	Chen <i>et al.</i> (2021)
Marine fish	<i>Labridae</i>	Coral reef fish	<i>Thalassoma hardwicke</i>	MP (<5 mm) Fibres	Southern Taiwan	May 2017–March 2018	Chen <i>et al.</i> (2021)

(Continued)

Table A 3.2.8 Impacts of plastic ingestion by marine animals. (Continued)

List of Ingested Marine Animals	Family	Common Name	Species	Type Shape of Ingested Plastics	Location	Study Period	References
Marine fish	<i>Labridae</i>	Coral reef fish	<i>Thalassoma amblycephalum</i>	MP (<5 mm) Fibres	Southern Taiwan	May 2017– March 2018	Chen et al. (2021)
Marine fish	<i>Labridae</i>	Coral reef fish	<i>Halichoeres hortulanus</i>	MP (<5 mm) Fibres	Southern Taiwan	May 2017– March 2018	Chen et al. (2021)
Marine fish	<i>Labridae</i>	Coral reef fish	<i>Thalassoma quinquevittatum</i>	MP (<5 mm) Fibres	Southern Taiwan	May 2017– March 2018	Chen et al. (2021)
Marine fish	<i>Labridae</i>	Coral reef fish	<i>Halichoeres margaritaceus</i>	MP (<5 mm) Fibres	Southern Taiwan	May 2017– March 2018	Chen et al. (2021)
Marine fish	<i>Labridae</i>	Coral reef fish	<i>Cheilinus chlorourus</i>	MP (<5 mm) Fibres	Southern Taiwan	May 2017– March 2018	Chen et al. (2021)
Marine fish	<i>Mullidae</i>	Coral reef fish	<i>Parupeneus multifasciatus</i>	MP (<5 mm) Fibres	Southern Taiwan	May 2017– March 2018	Chen et al. (2021)
Marine fish	<i>Nemipteridae</i>	Coral reef fish	<i>Scolopsis lineata</i>	MP (<5 mm) Fibres	Southern Taiwan	May 2017– March 2018	Chen et al. (2021)
Marine fish	<i>Pomacentridae</i>	Coral reef fish	<i>Dascyllus trimaculatus</i>	MP (<5 mm) Fibres	Southern Taiwan	May 2017– March 2018	Chen et al. (2021)
Marine fish	<i>Pomacentridae</i>	Coral reef fish	<i>Abudefduf sordidus</i>	MP (<5 mm) Fibres	Southern Taiwan	May 2017– March 2018	Chen et al. (2021)

(Continued)

Table A 3.2.8 Impacts of plastic ingestion by marine animals. (Continued)

List of Ingested Marine Animals	Family	Common Name	Species	Type Shape of Ingested Plastics	Location	Study Period	References
Marine fish	<i>Pomacentridae</i>	Coral reef fish	<i>Neoglyphidodon melas</i>	MP (<5 mm) Fibres	Southern Taiwan	May 2017– March 2018	Chen et al. (2021)
Marine fish	<i>Pomacentridae</i>	Coral reef fish	<i>Amblyglyphidodon curacao</i>	MP (<5 mm) Fibres	Southern Taiwan	May 2017– March 2018	Chen et al. (2021)
Marine fish	<i>Pomacentridae</i>	Coral reef fish	<i>Stegastes albifasciatus</i>	MP (<5 mm) Fibres	Southern Taiwan	May 2017– March 2018	Chen et al. (2021)
Marine fish	<i>Pomacentridae</i>	Coral reef fish	<i>Plectroglyphidodon leucozonus</i>	MP (<5 mm) Fibres	Southern Taiwan	May 2017– March 2018	Chen et al. (2021)
Marine fish	<i>Pomacentridae</i>	Coral reef fish	<i>Thalassoma lutescens</i>	MP (<5 mm) Fibres	Southern Taiwan	May 2017– March 2018	Chen et al. (2021)
Marine fish	<i>Pseudochromidae</i>	Coral reef fish	<i>Labracinus cyclophthalmus</i>	MP (<5 mm) Fibres	Southern Taiwan	May 2017– March 2018	Chen et al. (2021)
Marine fish	<i>Scaridae</i>	Coral reef fish	<i>Scarus frenatus</i>	MP (<5 mm) Fibres	Southern Taiwan	May 2017– March 2018	Chen et al. (2021)

(Continued)

Table A 3.2.8 Impacts of plastic ingestion by marine animals. (Continued)

List of Ingested Marine Animals	Family	Common Name	Species	Type Shape of Ingested Plastics	Location	Study Period	References
Marine fish	<i>Serranidae</i>	Coral reef fish	<i>Epinephelus mema</i>	MP (<5 mm) Fibres	Southern Taiwan	May 2017– March 2018	Chen et al. (2021)
Marine fish	<i>Serranidae</i>	Coral reef fish	<i>Cephalopholis argus</i>	MP (<5 mm) Fibres	Southern Taiwan	May 2017– March 2018	Chen et al. (2021)
Marine fish	<i>Serranidae</i>	Coral reef fish	<i>Cephalopholis urodeta</i>	MP (<5 mm) Fibres	Southern Taiwan	May 2017– March 2018	Chen et al. (2021)
Marine fish	<i>Serranidae</i>	Coral reef fish	<i>Epinephelus hexagonatus</i>	MP (<5 mm) Fibres	Southern Taiwan	May 2017– March 2018	Chen et al. (2021)
Marine fish	<i>Trichiuridae</i>	Pelagic fish	<i>Trichiurus lepturus</i>	MP (<5 mm) Fibres	Southern Taiwan	May 2017– March 2018	Chen et al. (2021)
Marine fish	<i>Serranidae</i>	Pelagic fish	<i>Plectranthias kamii</i>	MP (<5 mm) Fibres	Southern Taiwan	May 2017– March 2018	Chen et al. (2021)
Marine fish	<i>Scombriidae</i>	Pelagic fish	<i>Scomberomorus commerson</i>	MP (<5 mm) Fibres	Southern Taiwan	May 2017– March 2018	Chen et al. (2021)
Marine fish	<i>Scombriidae</i>	Pelagic fish	<i>Acanthocybium solandri</i>	MP (<5 mm) Fibres	Southern Taiwan	May 2017– March 2018	Chen et al. (2021)

(Continued)

Table A 3.2.8 Impacts of plastic ingestion by marine animals. (Continued)

List of Ingested Marine Animals	Family	Common Name	Species	Type Shape of Ingested Plastics	Location	Study Period	References
Marine fish	<i>Polymixiidae</i>	Pelagic fish	<i>Polymixia</i> sp.	MP (<5 mm) Fibres	Southern Taiwan	May 2017– March 2018	Chen et al. (2021)
Marine fish	<i>Polynemidae</i>	Pelagic fish	<i>Eleutheronema rhadinum</i>	MP (<5 mm) Fibres	Southern Taiwan	May 2017– March 2018	Chen et al. (2021)
Marine fish	<i>Coryphaenidae</i>	Pelagic fish	<i>Coryphaena hippurus</i>	MP (<5 mm) Fibres	Southern Taiwan	May 2017– March 2018	Chen et al. (2021)

Note: IP = ingested plastics, MA = marine animals.

Chapter 4

Plastic litter investigations and surveillance

Ekbordin Winijkul, Thanapat Jansakoo and Nichakul Phosirikul

Table of Contents

4.1	Designing of the Monitoring and Assessment Programs	134
4.1.1	Role of monitoring and assessment programs	134
4.1.2	Life cycle and system dynamics model of the marine litter	135
4.1.3	Data requirement for monitoring.	138
4.1.4	Litter categories	139
4.1.5	General consideration.	142
4.1.6	Role of citizen science.	145
4.1.7	Rapid assessment survey.	146
4.1.8	Biological and ethical consideration	148
4.2	Plastic Litter Investigation	151
4.2.1	Plastic debris on shoreline	151
4.2.2	Plastic debris on the sea surface and in the water compartment	155
4.2.3	Plastic debris on the sea floor.	162
4.2.4	Plastic debris information from marine biota.	163
4.2.5	Plastic debris in the atmosphere	165
4.3	Plastic Identification Methods	169
4.3.1	Marking.	169
4.3.2	Identification of fishing gear.	169
4.3.3	Shape and form	169
4.3.4	Density	172
4.3.5	Color	173
4.3.6	Burn test	173
4.3.7	Microscopic identification	173
4.3.8	Infrared spectroscopy	174

4.3.9	Pyrolysis–gas chromatography/mass spectrometry (Pyr-GC/MS)	174
4.3.10	Raman spectroscopy	174
	References	176
	Annex A	180

The abundance of marine plastic litter is an important issue that many regions in the world are facing. Although most litter is found in densely populated regions, plastic problems can also be observed in remote areas far away from the mainland, such as the Arctic continent. Anthropogenic activities, both on land and in the sea, are the major sources of marine litter. Slow rates of degradation of plastic waste are also a significant reason making the amount of offshore plastic litter rise continually. Thus, marine plastic litter investigation plays a leading role in the management and monitoring of its impacts on our oceans and shores.

Over the last few decades, several organizations have been formed to handle the ecosystem challenges posed by marine plastic litter in oceans and on shores. However, the task of monitoring and surveillance at a global scale has been insufficient to get rid of the problem due to a lack of information and coordination among different organizations in each region. In 2003, UNEP's Regional Seas Program (RSP) and the Global Program of Action (GPA) developed a monitoring program, called 'Global Initiative on Marine Litter' to focus on 12 oceans that have been affected by severe plastic pollution. The investigation program provided guidelines and platforms, including partnership, coordination, and cooperation in campaigns to sustainably manage marine litter. Moreover, the 'Group of Experts on the Scientific Aspects of Marine Environmental Protection' (GESAMP) established a marine litter monitoring program focusing on microplastics which emerge in the marine environment. The 'Marine Strategy Framework Directive' was also adopted by the European Commission to achieve and maintain a good marine environment. The most recent publication by the Technical Subgroup on Marine Litter (TSGML) contains recommendations for monitoring programs for all types of marine debris.

In this chapter, the major guidelines and protocols which have been developed by each organization are summarized including a comparative analysis of the existing monitoring programs conducted around the world in different environments, such as on-shore, off-shore, atmosphere, marine biota, and site-selection information, survey methods and equipment. The methods used to identify plastic samples after collection are also discussed.

4.1 DESIGNING OF THE MONITORING AND ASSESSMENT PROGRAMS

4.1.1 Role of monitoring and assessment programs

The most effective ways to address marine macro- and micro-plastic litter problems are monitoring and assessment programs. The state or level of pollution should be investigated thoroughly to provide the information required to design the mitigation plan and promote adaptive management. However, an understanding of the policies will also help to develop an effective plastic survey plan.

Long-term assessment and survey programs on marine plastic litter should be set by repeated process and measurement to establish time

series (temporal distribution) of pollution and detect the baseline of the situation, such as the current number and types of different plastic items. Such information would play a key role in drafting the policies and helping determine the appropriate mitigation measures. Monitoring strategies can be explored further following other policies such as the risk on human health, compliance with national and international environmental regulations, impact on biodiversity, and influence on the economic sector. However, the limitations of government agencies and organizations should be considered while developing a survey plan.

Reliable data on marine plastic litter occurrence and mitigation plans are necessary so that the survey program can follow the accepted standards and practices. A key interest in the marine plastic litter generation rate can focus on man-made activities such as cargo transport, fisheries, aquaculture or recreational activities (e.g., tourism). Monitoring programs may be conducted based on specific products, brands or other sources of litter to generate interest for mitigation strategies. Monitoring programs can be separated to four main types where different central questions should be included as follows (Hutto & Belote, 2013):

- Surveillance monitoring: is there any condition that needs to be solved through management?
- Implementation monitoring: was implementation conducted as prescribed?
- Effective monitoring: did the monitoring activity effectively achieve the set goals?
- Ecological effect monitoring: were there unintended consequences of management activity?

A robust monitoring strategy is another key factor for the success of monitoring programs. Four key aspects of the monitoring strategy which should be included in any monitoring program (Hanke *et al.*, 2013) include:

- Spatial and temporal scales and the target areas should be defined for sample collection.
- Precise and repetitive sampling processes, as well as analytical procedures, should be conducted in the programs.
- The sampling scale and indicators to address issues should be linked with the consideration of the resource constraints.
- Suitable mapping and publication tools should be developed to visualize the status of the environment for each indicator.

In monitoring programs, designed for different spatial and political scales (local, regional, and global scale), the principles and key questions mentioned above should be considered with the methodologies and resources available to achieve the goals. Moreover, the harmony between stakeholders is a significant factor for wide-scale assessments.

4.1.2 Life cycle and system dynamics model of the marine litter

The life cycle model of marine litter is the key to understanding the transformation of litter in the environment. To develop assessment programs,

the major parameters that control the entry and removal of litter from the environment should be identified. For example, in the marine ecosystem, plastic litter may come from sea-based sources, such as recreational ships, fishing activities, and cargo transportation. Thereafter, plastic would continue to float at the sea surface until they sink or fragment into small pieces by physical and/or chemical mechanisms. The submerged plastic becomes benthic litter or when accumulated on the shoreline it becomes beach litter.

System dynamics models are simulation models that demonstrate considerable value across several different fields to help decision-makers understand and predict the dynamic behavior of complex systems in supporting the development of effective policy actions (Currie *et al.*, 2018). The system dynamics model has unique characteristics that can link policy actions with plastic waste problems. The model can be used to simulate the effectiveness of different policies or management of plastic wastes (macro and micro sizes) in different scales (city, country or region).

The flux and movement of litter debris from one pool to another is demonstrated in [Figure 4.1](#).

Flux rate values are measured and reported as rate function (e.g., tons per year, or tons of litter cast on the beach per year). Flux rates can be measured both directly (observation) and indirectly (estimation from inference or change in the number of debris in each pool over time). Furthermore, to demonstrate the long-term effects of marine litter, the model can be used to develop or manage the mitigation activity. However, some actual factors should be considered in the model as follows.

- The amount of litter will continue to increase as the input process (discards) exceeds the output process (collection or removal). Therefore, the accumulation rate of marine litter in the ocean and beach remains high.
- Decomposition is a slow process. Thus, in a short time scale (less than a year), decomposition can be disregarded from the model.
- Some plastics which contain toxic pollutants from additives are also the main factors of marine plastic pollution. Although many producers use alternative materials which make their products easier to decompose than the traditional materials, this results in increasing plastic debris of small size in the pool.
- Controlling the behavior of discards (input) plays a key role in succeeding in the goals to reduce the marine plastic debris in the pools. If we can reduce the waste at the source of pollutants such as harbors or recreational beaches by providing information or facilitating reception, we can manage and remove them from the downstream. Education is the main tool to reduce domestic plastic discarding.

To achieve the objectives of marine litter monitoring programs, they should incorporate awareness of the litter life cycle into their design to support analysis methods and mitigation strategy development. The system dynamics model can also be used to study the impacts of different policies on plastic waste in different environments.

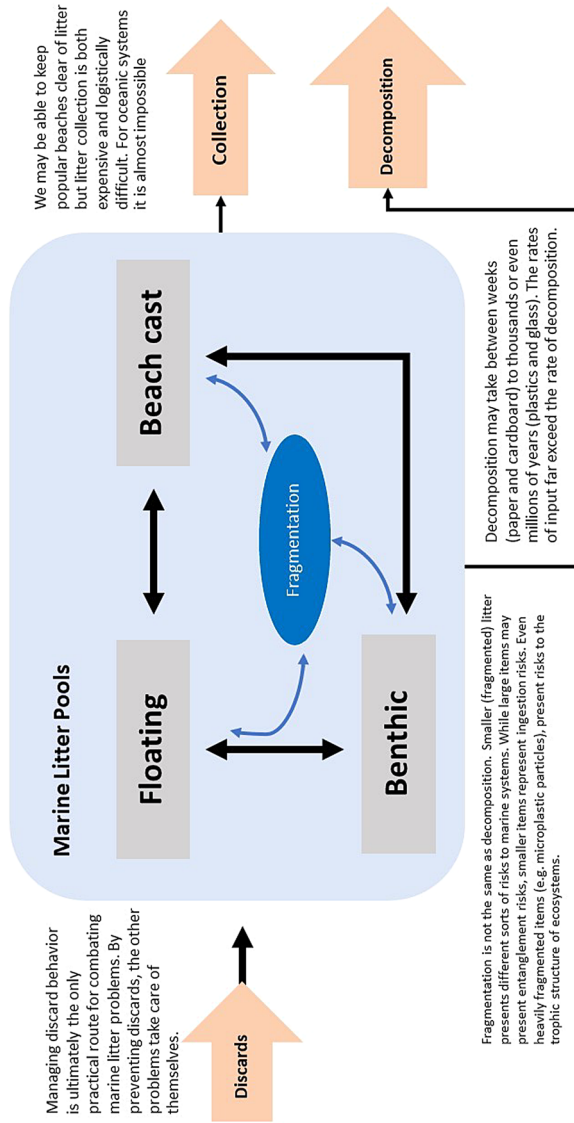

Figure 4.1 Schema representing the life cycle of marine litter (Source: UNEP, 2009).

4.1.3 Data requirement for monitoring

4.1.3.1 Measurement unit and data management

The measurement units differ depending on sampling methods, location, and the policy of the monitoring program. To investigate the abundance of marine plastic litter, the number of litter or their mass (g or kg) per unit (distance, area, or volume) is to be demonstrated depending on the compartment of the sampling site and the monitoring method. In the calculation of the accumulation rate, the temporal resolution must be incorporated to show the magnitude and dynamics of plastic abundance on the environment such as stranding litter on the shoreline during tidal cycles and seasonal accumulation.

Eriksen *et al.* (2014) and Doyle *et al.* (2011) investigated marine litter in different locations and found that most marine litter on the shoreline was smaller than that in the water compartment. Thus, the number, rather than the mass, was a more suitable measurement used to report the abundance. Therefore, the measurement unit is dominated by the size of items and sampling location. Moreover, the number of debris is an important policy aspect when the focus is on the overall assessment of marine litter abundance. In the case of marine litter in seafood, the number of microplastics would be more useful than mass when the focus is on health effects. On the other hand, mass of litter is more important when considering management of existing litter in the environment (how to transport such litter after collection to the final disposal site). Several factors as follows explain why the mass of debris is more difficult to assess than the number of litter.

- (a) It is difficult to weigh the actual mass when the items are very large.
- (b) Other debris and sand particles may be contaminated by the large debris.
- (c) Wet and dry conditions of debris influence the actual mass.
- (d) The sealed items may hold contents that make the actual value undetermined while conducting a camera survey to count the items.

Microplastics are a challenging case not only in the sampling collection process, but also in the reporting process because their weights are very small, and the concentration of microplastics in the natural environment is not high. Thus, for microplastics, number concentration is the common unit used to report the concentration of microplastics in the environment.

4.1.3.2 Metadata

The monitoring data in the field survey needs to be collected in a structural or formal form to ensure the reliability of the data for the assessment program. Metadata is additional information used to describe the monitoring activity including basic details such as survey identifier, location, data of collecting data, equipment, and general environmental factors which influence sampling results. Datasheets will be required for reporting. This information is thus important for both the current program and subsequent studies where the information on the metadata of the current program can inform subsequent studies. An example of datasheets is presented in Annexes.

4.1.3.3 Data management

A clear data management policy in monitoring programs is an important aspect that should be considered in order to achieve the goals in terms of quality assurance (QA), quality control (QC), storage, sharing, reporting, and publication.

QA and QC are important factors that can guarantee the reliability of the investigation program. Normally, samples will be taken by different people or observers. To avoid any mistakes in the data, QA and QC must be incorporated.

4.1.3.3.1 Quality assurance

QA is the procedure to guarantee that the samples taken will follow the standard procedure (if any) or standards as qualified by experts who have experience in the related field. As part of the marine plastic debris investigation, several organizations have developed monitoring guidelines to be used in different environments, such as shorelines, oceans, and rivers. For example, the Group of Experts on the Scientific Aspects of Marine Environmental Protection (GESAMP) published the guidelines for the monitoring and assessment of plastic litter in the ocean, and the NOAA Marine Debris Program published recommendations for monitoring debris trends in the marine environment. Such guidelines or recommendations provide advice on the practical methodology to assess the abundance and distribution of debris in marine environment. One common recommendation from such guidelines is to use similar protocols so that the data from different programs can be utilized for long-term and large-scale monitoring programs. Intercomparison among different programs with the same set of data can also be done to assess QA of the protocol and information collected among the programs.

4.1.3.3.2 Quality control

QC is a process that investigates both the quality and quantity of the field survey data. This process includes training of the field investigators and calibration of the monitoring equipment among others to follow the standard or planned monitoring protocol. QC must be included in the processes for pre-, during, and post-monitoring activities. For marine plastic investigation, second observers may be assigned to monitor some fractions of the total number of the transects to control the quality of the data collection (Lippiatt *et al.*, 2013).

4.1.4 Litter categories

In marine litter investigation, types or categories of waste play a key role in mitigation planning. For example, in the waste management measures at the port and the harbor, an effective way to reduce marine litter is to restrict the use of certain products such as plastic bags and plastic straws (UNEP, 2016). Moreover, litter categories can indicate the potential source of litter. In general, it is easier to track the sources and identify the origin of macro-plastic litter when compared to microplastics. Normally, the categories of litter depend on the policy or the objectives of each organization that develops their standard guidelines. For example, Figure 4.2 and Table 4.1 show hierarchical category

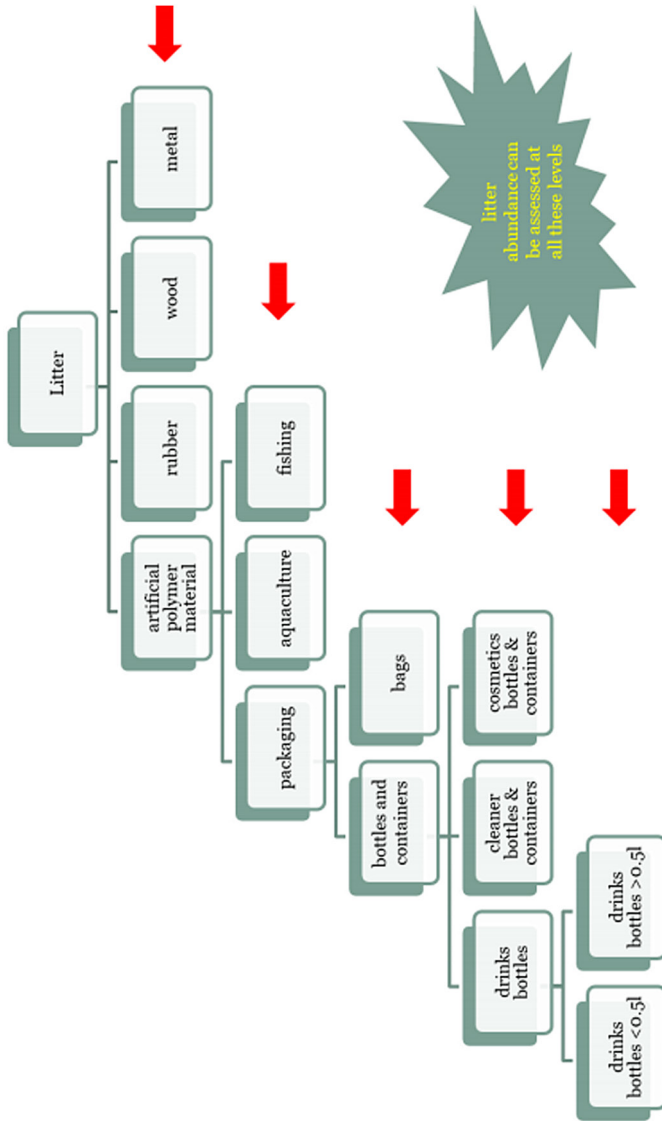

Figure 4.2 Marine litter hierarchical category lists for Europe investigation program (Source: Fleet et al., 2021).

Table 4.1 Example of hierarchical category list for Sea floor litters.

Main Category	Sub-Category – Example	Main Category	Sub-Category – Example
Plastic	Bottle < 2 L	Wood – machined	Crated
	Bottle, drum > 2 L		Fish boxes
	Cigarette lighter		Wood < 0.5 m
	Fishing net	Metal	Bottle cap
	Buoy		Aerosol can
	Foamed plastic buoy		Drink can
	Foamed plastic packaging		Food can
Rubber	Boots	Glass	Electrical appliances
	Balloon		Light bulb
	Tire		Bottle
Cloth	Clothing	Ceramic	Tile
	Sacking		Pot
	Furnish		
Paper/Cardboard	Bags	Sanitary	Condom
	Cardboard sheet		Cotton bud stick
	Cigarette packet		Tampon and applicator
	Newspapers and magazines	Medical waste	Syringe
			Medical container

Source: [OSPAR \(2010\)](#)

lists of marine litter from MSFD and OSPAR, respectively. The category list tends to be hierarchical and the number of major- and sub-categories and additional data can be flexibly adjusted. Also, the categories can be based on types of material (plastic, wood, glass, etc.), usage function (packaging, fishing gear, disposable items, etc.) or brand. In each monitoring program, the program manager needs to decide on categorization of the litter which can then be linked to the objectives and outputs of the program.

In the manufacturing process, trading marks and addresses are shown on product labels to indicate the brand and the place of manufacture. These labels become useful sources of information to investigate product origins when unwanted products enter the environmental compartment. For instance, debris that originates from a ship can travel to the sampling area far away from the source due to the ocean circulation conditions and other environmental conditions. Thus, it can be advantageous to include brands in the categories for better information

on the potential sources. Moreover, the policy should be used to determine the level of information that the investigation should have to achieve the goals.

4.1.5 General consideration

Monitoring and assessment both require a consistent approach in terms of sampling location, frequency, information processing and sample characterization. To ensure that the monitoring method is reliable, the harmonized approach suggests the use of the 'standards' (e.g., ISO, EN, ASTM). However, monitoring programs should be flexible for the appropriate policy, in term of economic, social or environmental, to be applicable in each situation. Marine litter monitoring strategies cannot thus be based on the logic of 'one size fits all' because they are a result of combination of compromises that define their magnitude and complexity. The monitoring and assessment strategies should involve the influencing factors of the abundance of marine debris such as socio-ecological factors that can be used to design appropriate spatial and temporal components of the program.

The number and location of sites for monitoring and assessment programs can be determined by the spatial component, that is, how big the study area is, while the temporal component, that is, what time this assessment can explain, can define the frequency and number of samplings.

4.1.5.1 Site selection for the sampling program

The selection of sampling points can justify the quality and utility of the program. The main key factor is to ensure that the sampling location can represent the state of the littered area (length of coastline or whole region) depending on the randomized selection of the sampling plots. In other cases, site selection can follow the existing assessment protocols such as annual fisheries stock assessment programs and cruising routes.

The following levels of resolution should be defined:

- Spatial resolution: size of individual sample units (e.g., length of beach transects in meters)
- Temporal resolution: frequency of individual sample units (e.g., month, quarter, annual)
- Sample/ecological resolution: defined collection criteria (e.g., based on size or type of litter items)

The extent and resolution should be considered when describing the scale of influence for a marine litter monitoring program as shown in [Table 4.2](#).

A degree of sampling replication is necessary to evaluate the degree of the inherent variability of the system. The sample variation can be determined by using multiple sample units which are adjacent to time or space (i.e., standard error and mean of the sample). Moreover, statistical methods such as power analysis can help to determine the minimum sample size.

The choice of the monitoring and assessment sites depends on the considered parameters, including the presence of vulnerable or sensitive habitats, the distribution of activities representing potential sea-based sources of marine litter (such as fisheries, aquaculture, shipping, off-shore industries), and

Table 4.2 Scale of influence for marine litter monitoring program.

Scale of influence		
Spatial	Temporal	Ecological
Target population (extent)		
Global	Decadal	The entire assemblage of items meeting the collection criteria
National	Annual	
Regional	Monthly	
Local	Weekly	
Sample unit resolution		
Shoreline	Monthly	Individual items meeting the collection criteria
Transect	Weekly	
Quadrat	Daily	

Source: [GESAMP \(2019\)](#)

potential land-based sources (such as coastal tourism, high coastal population density, river outfall). Furthermore, the tendency of the accumulation area of marine litter should be considered as a representative of socio-economic impact. These hotspots may occur close to the source or at a considerable distance. The monitoring and assessment program can integrate with an existing program such as assessment of biodiversity and fish stock among others which would be suitable for litter monitoring as well, and the cost and time to run the monitoring program will be reduced (cost-effective).

In terms of the replication method, replicate sampling should be conducted to determine the variable of sampling in the litter abundance at each location. The replication process can be by space (e.g., three closely spaced samples taken) or by time period (e.g., daily sampling over one week at each location). However, if the monitoring program focuses on temporal variation, the rolling-mean record would be more suitable for the program. For instance, a moving average over five years to detect a trend over a decadal time scale should be considered.

Moreover, ocean circular modeling can be applied with the sampling design process to predict the hotspot or accumulation area of marine debris abundance. However, the precision of the model will depend on several factors including the amount and quality of information on the source, the characteristics of litter and oceanography ([Hardesty *et al.*, 2016, 2017](#)).

4.1.5.2 The cost of marine litter monitoring

Another significant factor to consider when developing an investigation program on marine plastic litter is the cost. Many factors influence the cost of monitoring programs such as staff cost, laboratory cost, equipment cost, and transportation cost. Many monitoring programs can be conducted in collaboration with existing monitoring programs on other aspects such as a fishing stock study as an opportunity to reduce the cost of the monitoring program. Moreover, joining regional monitoring programs is another way to save cost. Thus, the same

protocol in terms of sampling sites and methodologies should be considered for the consistency of the data acquired from the monitoring program.

Moreover, using volunteers to collect the samples such as organizing an ocean clean-up activity is another way to reduce cost. The use of modeling tools, such as ocean circulation models, to identify spatial and temporal variations of plastic litter during different seasons, helps in designing the monitoring locations more effectively with a minimum cost.

Factors that can affect the cost effectiveness of monitoring programs are as follows.

4.1.5.2.1 Technology and methodology

Improving technology and methodology can reduce the cost of monitoring programs and analysis in the laboratory. For example, tablets and smartphones, as well as digital cameras, can be used to collect data and send it directly to the cloud system for recording. Modelling of marine debris distribution is another way to reduce the cost of both regional and global monitoring programs. Remote sensing techniques from a satellite validated with the field survey are efficient and reliable tools to investigate plastic litter on a large scale. [Themistocleous *et al.* \(2020\)](#), [Biermann *et al.* \(2020\)](#) and several other studies developed methodologies using the Sentinel-2 satellite images and others to identify plastic litter on the sea surface for monitoring, collection, and disposal. Thus, the cost associated with field surveys can be reduced with the newly developed methodology and the advancement in the monitoring and assessment technologies. Video surveillance using machine learning is also used to monitor the amount and type of plastic floating in the river or other water bodies.

4.1.5.2.2 Integration with other monitoring programs

Integrating a marine litter monitoring program with existing protocols such as fishing and marine biota is the key in achieving high cost effectiveness. Nowadays, most monitoring programs use this method to reduce the investment cost. For example, on the seafloor, several countries integrate their monitoring programs with fish stock surveys using trawl surveys while diving and video techniques are used for shallow seafloor areas to investigate how the debris integrate with the biotopes monitoring programs. Moreover, on the water surface, the floating plastic debris sampling program can be integrated with hydrography and plankton monitoring programs so that the investment cost in terms of transportation to collect the samples can be reduced. The focus is not only on the environment compartment but also on the marine biota which is used to investigate the plastic issues in the sea for example dead sea animals, beached birds, and bird colonies. However, not all existing monitoring programs can be integrated with marine debris tracking. Proper design should be considered to achieve the monitoring purposes.

4.1.5.2.3 Volunteers

Employing volunteers to identify marine litter is another way to reduce the monitoring cost. Although some parameters are not suitably identifiable

by volunteers since some litter requires specialists or experts who possess sophisticated technology and specific knowledge to collect the highest reliable and precise samples, the cost can greatly increase compared with employing volunteers. Moreover, employing volunteers can increase awareness and public engagement for marine litter prevention. Many countries use this approach to simplify monitoring programs based on activities such as ‘ocean cleanup day’ for the shoreline debris monitoring using an application on smartphones to keep track of the amount of litter collected and send the data to the database of organizations that own the application. Section 4.1.6 provides more information on the role of citizen science.

4.1.5.2.4 Refining questions

The initial question that drives a monitoring program is another important factor that influences the cost of the program. For example, when the initial question is ‘Does marine debris on the sea surface in the Pacific Ocean increase?’, it means that this monitoring program requires a more expensive setup than a smaller sea area and requires more than one-time monitoring. Thus, site selection and objectives of a monitoring program are the main factors that should be considered. GESAMP (2019) suggested that marine litter investigation at a large scale such as global and regional scales should be conducted through international collaborations in order to achieve the goals and reduce the monitoring cost that each organization must bear.

4.1.6 Role of citizen science

Over the last few decades, marine debris has been investigated by professional scientists. However, using volunteers has been a long tradition when conducting a monitoring program in assessable areas such as shorelines (Hidalgo-Ruz & Thiel, 2015; Zettler *et al.* 2013). Citizen scientists participated in a wide range of activities to collect specific items for identification, analysis, data evaluation and publication of the results.

Recently, many protocols developed to monitor marine litter such as UNEP and GESAMP have provided guidance and simple sampling tools to collect data for citizen scientists. The use of smartphone applications can improve the performance and quality of data. A good case study of this approach is ‘Marine Debris Tracker’ powered by Morgan Stanley and National Geographic. The application is an open data citizen science movement. Another example is the ‘pLitter’ program which is an online image annotation platform developed by the Geoinformatics Center at the Asian Institute of Technology in Thailand to support the United Nations Environment Program’s (UNEP) CounterMEASURE project. The pLitter gives citizen scientists the power to improve their communities’ environmental health using a platform with a machine-learning model to help the users automatically identify plastic litter.

Moreover, the complexity of a sampling program determines the role of citizens. For some survey programs, citizens may conduct the survey by themselves while they can support or assist scientists in their sampling efforts which is a more complex process. QC and QA are important aspects that should be considered in citizen science projects to control the quality of the data.

The roles of citizen scientists in marine debris investigation include observation of litter impact, collection of specific litter items, a bulk estimate of the amount of litter, frequency data on litter type, and quantitative data on litter densities (Figure 4.3). For instance, stranded marine biota monitoring can be done by volunteers because it does not require sophisticated technology or tools to record the data while using an institutional program would probably be more expensive. Moreover, the International Pellet Watch Program, which was established by the Tokyo University of Agriculture and Technology to investigate the contaminated pollutants and their impact, suggested that participants should carefully collect the samples and place them in aluminum foil before sending them for analysis in a laboratory. In another aspect, citizen science can help scientists to analyze samples such as identifying the fish bite marks on plastic items or the type of plastic items found in the carcasses of sea birds.

Furthermore, involving other activities to estimate the marine litter on the shoreline in an ocean clean-up activity is another example of how citizens can have roles in a monitoring program. Clean-up programs can help scientists identify hotspots of plastic litter abundance, including the categories of different items on the beach. Some citizen projects aim to produce quantitative data on the litter (total number of litter items per unit area or length). Normally, professional scientists participate in a program with volunteers to ensure the reliability of data and comparability.

4.1.7 Rapid assessment survey

Rapid assessment survey is a useful method to monitor plastic trash. It provides an initial snapshot of the distribution and abundance of litter. Generally, a rapid assessment survey is conducted before developing a monitoring program to assess the impact of natural disasters such as the aftermath of tsunamis and typhoons. Normally, rapid trash assessment is based on a visual survey. It can produce both qualitative and semi-quantitative estimates of litter abundance and the composition of waste, and provide sufficient information for direct monitoring design. Moreover, a rapid assessment survey does not require much investment and time to conduct the program, and therefore it is a suitable method for irregular situational surveys.

Rapid assessments may be incorporated with citizen science to provide information to determine and address issues. One example is the Marine Debris Monitoring Toolbox, developed by NOAA for the Marine Debris Monitoring and Assessment Project (MDMAP). Rapid assessments may not only rely on field surveys, some can also utilize satellite image data (Doyle *et al.*, 2011; Mace, 2012; Moy *et al.*, 2018). In 2018, Lebreton and their colleagues conducted a large-scale rapid assessment based on satellite image data. They found that it is a very useful tool for spatial distribution analysis and is a cost-effective method. However, there are many innovative techniques available to capture and collect samples without any physical touch, including balloon-assisted photographs (Nakashima *et al.*, 2011), ortho-photographs from aerial vehicles and drones (Deidun *et al.*, 2018; Mot *et al.*, 2018). Moreover, artificial intelligence

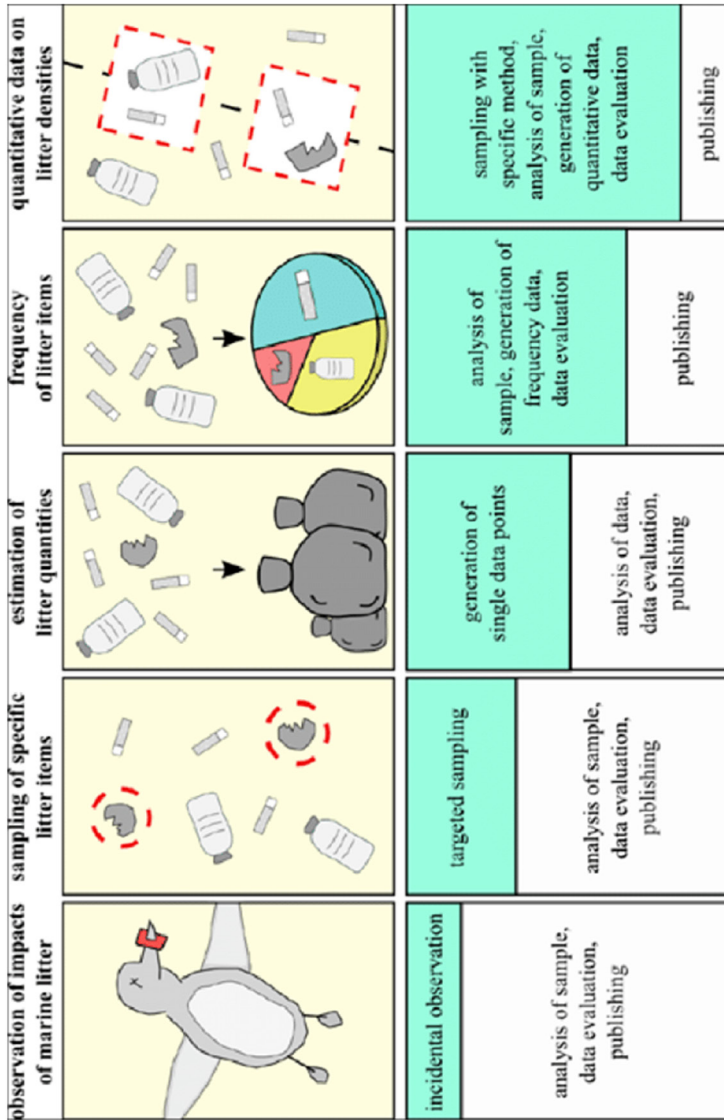

Figure 4.3 Four levels of participation of citizen scientists in marine litter research (Source: GESAMP, 2019).

technology has been applied to develop machine-learning algorithms for the interpretation and identification of plastic litter from remote imagery (Acuna-Ruz *et al.*, 2018).

The rapid assessment survey for marine litter identification in the accumulation zone or area is a useful toolkit to provide information for monitoring and developing programs. In 2020, Andriolo and colleagues used an unmanned aerial vehicle (UAV) and a mobile application on a smartphone to identify the macro-marine debris, which accumulated on the shoreline and coastal dunes on The Quiaios-Mira coast. They found that plastic is the most abundant material (76%) of all waste that accumulated on the sea beach. The plastics identified included Styrofoam fragments and plastic bottles. Moreover, in terms of spatial distribution, the highest density area of the litter was found at the foredune, with items associated with the recreational activities on the beach (Figure 4.4).

Using an innovative technique such as aerial imagery from a drone and a plane is the best method to rapidly monitor marine litter during natural disasters or special events related to human activities. Although this technique does not provide details or categories of the waste, it can provide initial information on the study area. Moreover, to define the accumulation zone, modeling is another advanced method that can be incorporated with the rapid assessment program based on machine learning. Such a model will require a lot of factors to be input into the model such as currents, circulation patterns, coastline structure, and meteorology (GESAMP, 2019). In conclusion, the rapid assessment program is a useful tool that scientists should conduct before launching a campaign to monitor marine litter because it can reduce the cost and time to operate the program, and it can also help the scientists to conduct a full monitoring program in each area that face the issues.

4.1.8 Biological and ethical consideration

The interaction of plastic litter with marine biota and the environment can be investigated by using biological indicators. Four main aspects, namely distribution, sensitivity, mobility and movement of the species, and knowledge of its biology should be taken into consideration before defining suitable indicators. Normally, due to the limitation of distribution of range, the biological indicator would be specific in each area or region while the migrated species which have high mobility can provide data on a large scale. Moreover, additional information such as age, size, and development stages can prove the vulnerability of the living organisms that are affected by the marine plastics.

Furthermore, the conservative information of the vulnerable species must be considered in the monitoring program based on the marine biota. Thus, using carcasses or stranded animals (Figure 4.5) to investigate and monitor the abundance of litter can provide useful information for data analysis. For example, many reports of ingestion of plastics by turtles and cetaceans are based on samples collected from animals. However, due to the difference in regulations in each country, the study must consider the ethical aspect in the community to eliminate any international conflict which may occur due to the monitoring program.

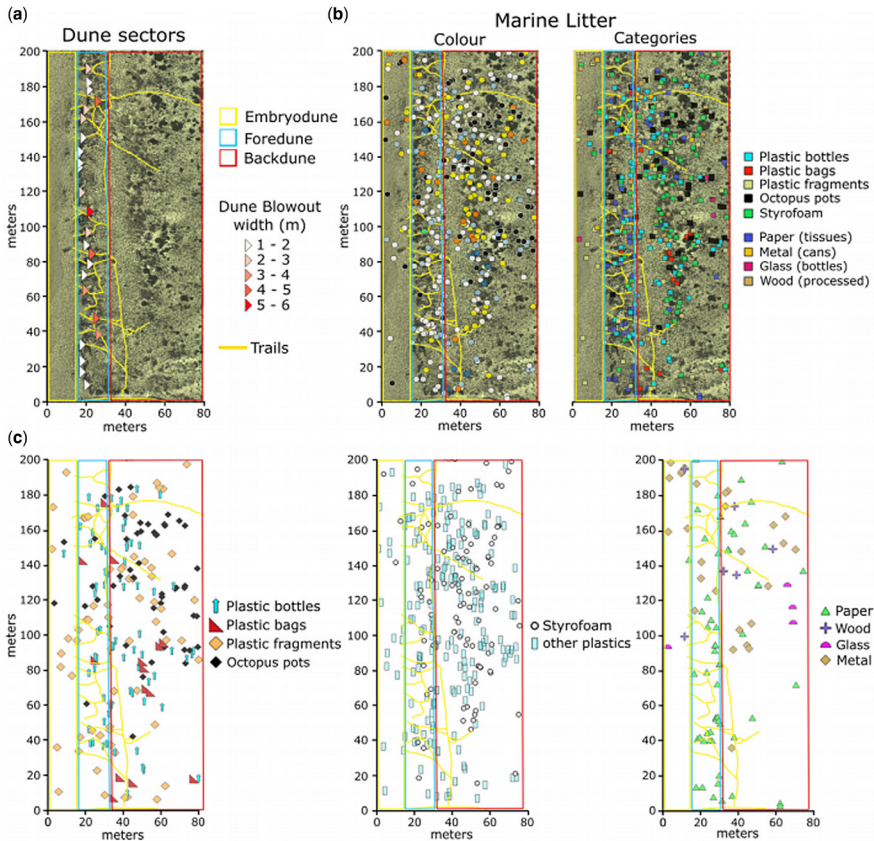

Figure 4.4 Dune sectors and marine litter (ML) maps. (a) Zonation of dune sectors: embryo dune (yellow rectangle), foredune (cyan rectangle), backdune (red rectangle). Yellow lines indicate marked trails. Triangles show dune blowouts, each of which placed on their landward intrusion limit: colour tones represent the width, from white (b1 m) to red (6 m). (b) Marine litter maps based on item colours (left) and categories (right). (c) Maps based on ML categories and types.

GESAMP has provided guidelines for the good indicators of species or groups in their 2019 Report. The first thing that monitoring program developers must be concerned with is the regional representation to illustrate the impact of litter in that area and the site selection in each environmental compartment. The samples must also be collected from non-threatened or unprotected species. However, sampling collection from carcasses is the best method to conserve their species. Moreover, the chosen species for sampling must be in abundance in the environment. Importantly, the sampling species must be linkable to the impacts and the effects of the pollutant. In addition, the pattern of the species' activity is another significant factor that scientists should consider. The feeding



Figure 4.5 A sperm whale was found with a ball of litter in its stomach weighing 100 kg (Source: Ng, 2019).

behavior of the bioindicator is one of the patterns that influences the sample (GESAMP, 2016). For example, to monitor the plastic abundance on the sea floor, the suitable bio-indicator should be the feeding species that consume organic matter settled on the sediment. Such species include annelid worms and echinoderms (Bour *et al.*, 2018).

In addition, the predation and scavenging species are the best indicators for monitoring the microplastic accumulation in the marine biota. Toxic substances will be transferred to the highest level of consumers in the food web by passing through their food or prey. Thus, predators will accumulate more substances than their preys due to the biomagnification process (Lusher *et al.*, 2018).

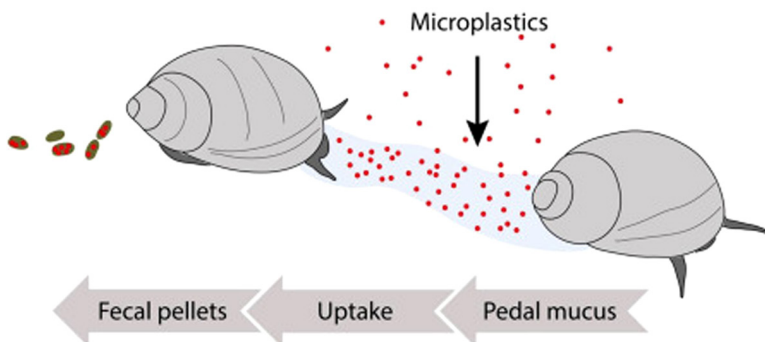

Figure 4.6 Microplastic contaminated in the pedal mucus of gastropod species (Source: Gutow *et al.*, 2019).

Not only the carnivorous species but also the biota who has a grazing feeding behavior can also be an indicator. For example, the biota of the gastropods (Figure 4.6), such as true limpets (*Patella* sp.) and common periwinkle (*Littorina littorea*), feed by scraping on the surface of algae in the water. Hence, the microplastics that attach and adhere to the algae surface may be consumed by them (Gutow *et al.*, 2019).

4.2 PLASTIC LITTER INVESTIGATION

4.2.1 Plastic debris on shoreline

Shoreline is considered the most important compartment for monitoring because it is the interface between sea and land, and because of its closeness to the land-based sources. Thus, it is the first environmental compartment that should be considered for quantifying marine litter. Shorelines tend to be highly dynamic due to a combination of oceanographic (tides, waves, and currents) and metrological (wind and rainfall) patterns. Moreover, the nature of the shoreline, such as mud flats, sand, cobber, boulders, wave-cut platform and slope, and time dependency, influences the distribution of debris abundance. In this section, an investigation program which followed the recommendation in the GESAMP (2019) for the collection of the samples on the shorelines based on the size is discussed.

4.2.1.1 Macro- and mega-litters

Several organizations provide guidelines and recommendations for monitoring and assessment of macro- and mega-litter on the shoreline. OSPAR protocol (2010) defines the sampling unit as a fixed section of beach covering the whole area between the water edge to the back of the beach as shown in Figure 4.7; within the 1000 m section to observe objects of <50 cm in size.

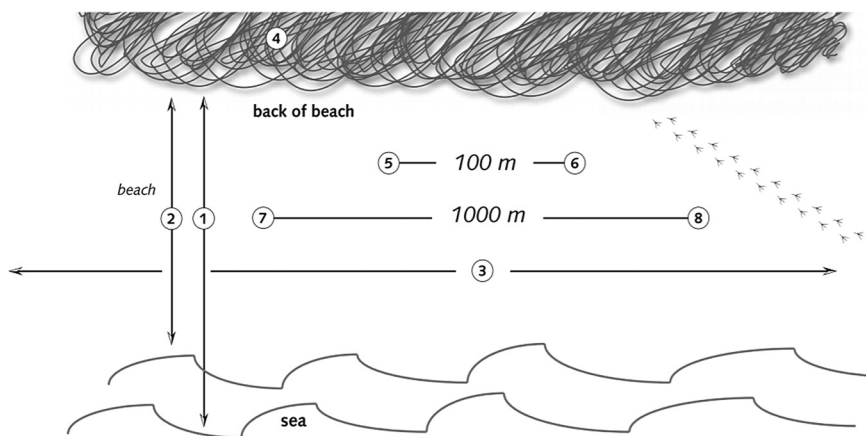

Figure 4.7 OSPAR protocol sampling area of the shoreline monitoring and assessment program (Source: OSPAR, 2010).

NOAA protocol suggests the area of 5 m wide transects perpendicular to water edge over a distance of 100 m of shore length to record objects of >25 mm in size and specify all items visible to the naked eye (>5 mm) as shown in [Figure 4.8](#). The NOAA protocol method suggests using this data within standard length (100 m) to enhance data compatibility.

The upper limit of the shoreline monitoring and assessment program can be defined by natural and artificial solid barriers. The upper limit will be determined by consideration of the extremely high-water spring tides, tidal surges and influence of a storm. Seaweed and natural materials can often get stranded with debris. Thus, samples from at least 2 m of backshore vegetation should be recorded.

Drones have been used to monitor plastic debris on the shore since they can cover larger areas in a shorter time. Moreover, drones can access a location which is difficult to reach on foot. However, the appropriate height ([Figure 4.9](#)) and the flying route are major parameters that determine the success of the monitoring program when using drones. Photographs obtained from drones will then be further processed to identify whether or not the items captured in the photographs are plastics using manual identification or automatic use of machine learning.

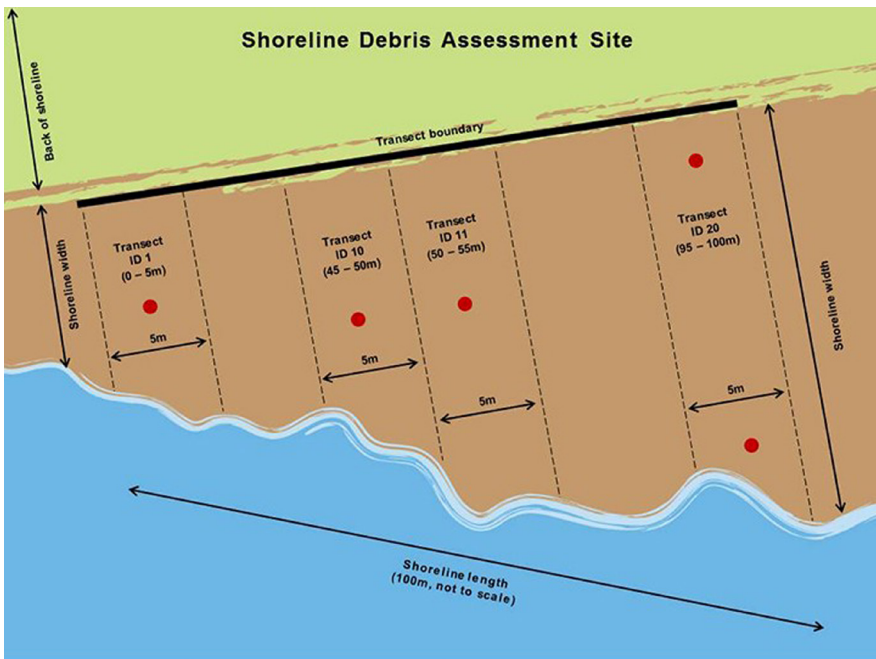

Figure 4.8 Shoreline debris assessment site (Source: [Lippiatt et al., 2013](#)).

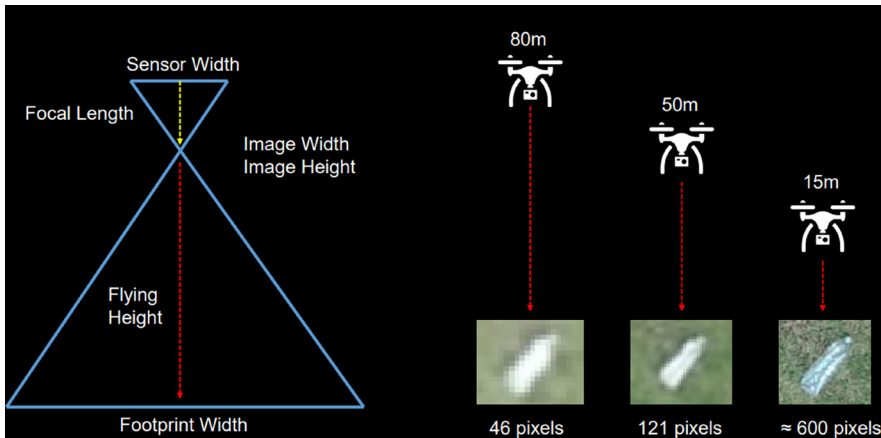

Figure 4.9 Drone image and resolution (Source: Gunasekara, 2019).

4.2.1.2 Buried macro-plastics

Buried macro-plastic samples can be collected using a sieve (10–20 mm) taken from a trench along a transect. The size of the sieve should be smaller than the lower limit of the macro-plastics size range to increase the retaining probability of the samples with irregular shapes. Moreover, the littered items can be sorted using hands because they are easy to observe. The stability of the deposits and availability of personnel, and the dynamics of the sampling environment such as the depth of the wave should be considered when determining the depth of the vertical section.

4.2.1.3 Meso-litter

For the meso-litter sampling (5–25 mm), it is not important to identify all items as is done with macro-plastics, but it is adopted in a consistent approach by using sieve. For instance, the representation of the sampling regime can be determined by randomization. A 1-m quadrant will be put along a transect perpendicular on the shoreline, and a 5-mm sieve size will be used to filter the sample. Then, the forceps will be used to transfer the samples from the sieve to designated containers.

4.2.1.4 Micro-litter

Micro-litter can be collected from the surface using the same procedure used for the meso-litter by sieving an extending range of mesh such as <5, <2, <1, <0.5 and <0.25 mm. However, this method may be impractical for the routine monitoring in the field since it requires great effort to identify microplastics. The European MSFD provides protocols to collect microplastics samples and recommends that at least two fractions, 1.5 mm and 0.02–1 mm, should be collected. A 1.5 mm fraction can be achieved in the field, while an additional fraction is best analyzed in the laboratory.

Microplastic contamination can occur at any stage in the sampling process from fibers from clothing to airborne microplastics during transportation. Thus, the 'blank sampling' should be collected to quantify any contamination that may occur during sampling.

4.2.1.5 Number and mass of sampling

All littered items (macro-, meso-, micro-plastics) can be counted and weighed. However, the samples collected from the beach are often wet and soiled with sand. Thus, it is hard to weigh them accurately in the field. Some items may be large but have less weight. Therefore, in the case of large items, the counting method is a more suitable recording method, and the weight can be an estimated mass based on an independent measure (e.g., mass of an empty drink bottle). However, this method does not provide certainty in estimation.

4.2.1.6 Sample replicates

The replication process in time and space is important. Commonly, at least three replicates of samples are necessary to present the consistency of the sample collected. Sample replicates can also be used to understand the pattern of litter loading on the beach to determine the dynamics of waste in the sampling area.

4.2.1.7 Sampling on other shoreline types

On rocky shores, it can be difficult to access samples due to the rugged terrains. Litter can be accumulated in such areas by waves since the rugged structure traps litter. Moreover, in rocky shore areas, many kinds of organisms such as seaweed, and coral can be found. Thus, these organisms can trap fishing lines and other fibrous litter. Monitoring programs in these areas following the same protocol for sandy beach monitoring are feasible for large items. However, it should be noted that the daily sampling number may reduce as the littered items on the shoreline may become buried or flow into the ocean.

Mangrove forests serve as both traps and filters for marine debris such as plastic bags and ropes, while smaller pieces of marine litter will be deeply accumulated in the forest ([Figure 4.10](#)). Although mangrove forest is as



Figure 4.10 Meso- and micro-plastic litter found in the mangrove area.

important as the shoreline in terms of trapping marine debris, there are fewer monitoring programs that survey marine litter in the mangrove forest. The dense vegetation complicates the sampling of larger litter, while the sediment core can be identified as micro-plastics abundance in the mangrove forests.

4.2.2 Plastic debris on the sea surface and in the water compartment

There are several sampling methods to monitor and collect marine plastic debris in the water compartment. For the sea surface, the most common method is using net tows such as Neuston net, menta trawl or mega-trawl to collect floating macro-, meso-, and microplastics. Moreover, other methods such as aerial surveys, photographic surveys and direct observation from a ship can be applied in the monitoring and assessment programs. Table 4.3 provides examples of methods used for sampling plastics in the open water surface compartment.

In terms of water columns, six approaches are used to collect samples (Table 4.4). However, in water columns, larger plastic-littered items are not as abundant as the smaller ones. Thus, care should be taken to avoid contamination of the samples from small plastics from the net tow and workers' clothing.

For large litter (macro- and mega-plastics), the fisheries activity provides opportunity to observe and report the fishing gear. However, results will be heavily biased because it is difficult to analyze and determine the actual volume.

4.2.2.1 Ship surveys

Over the last few decades, several monitoring programs have been developed to investigate plastic litter in the water compartments of both on-land and ocean sources using ship surveys combined with other techniques. In this section, the methods and equipment employed by scientists in monitoring programs will be discussed.

4.2.2.1.1 Visual observation survey for macro- and mega-plastics litter

Marine plastics litter observation based on eyesight is the basic technique for monitoring programs because it does not require high technology equipment or skills. However, visual surveys require some equipment to assist in investigating activity and collecting data such as binoculars, stopwatches, and datasheets. Moreover, digital cameras and mobile phones can be used to identify debris and separate the litter from other floating marine litter.

A common technique that various studies have used to collect data through visual surveys is fixed width transects or distance sampling.

- Fixed width transects assume that all macro-plastic in the search area is detected. The width of the sample depends on the size of the ship, the height and the location of the observer. Normally, 30 m from the ship is determined as the transect width. The transect should be located on one side of the vessel, typically encompassing at 90° when the viewer is behind the bow. (All the litter that can be observed in the first quadrant from the front of the ship is recorded.)

Table 4.3 Examples of methods used for sampling plastics in the open water surface compartment.

Method	Explanation	Advantages	Limitations	Example of Use
Net tows (manta trawl, Neuston net)	<ul style="list-style-type: none"> Fine-mesh net attached to a large rectangular frame (e.g. 0.5–1.0 m wide and 0.4 m high) was developed for sampling surface and water column waters for plankton, insects, and another small biota. Manta trawl with floating wings to keep it on the surface. Net length typically 1–8 m. Mesh size typically 200–355 μm Standard deployment configured with long side parallel to water surface 	<ul style="list-style-type: none"> Can be deployed from small to large vessels. Underway sampling Use of flow meter to estimate volume. 	<ul style="list-style-type: none"> Use is weather dependent. Care needed to minimize contamination from sampling vessel and tow ropes. Can only estimate the volume of water filtered when the flow meter is used, and the frame is completely immersed. Towing speed and time must be limited to avoid clogging the net and under-sampling surface waters; vessel speed may need to be restricted Under-samples material smaller than mesh size. 	Viršek <i>et al.</i> (2016)
Mega net	<ul style="list-style-type: none"> Large net, up to 4 m wide for sampling larger litter than with a standard manta or Neuston net 	<ul style="list-style-type: none"> Captures macro and meso litter 	<ul style="list-style-type: none"> Use is weather dependent. Infrastructure needed to store, deploy and retrieve is great. 	Doyle <i>et al.</i> (2011)

(Continued)

Table 4.3 Examples of methods used for sampling plastics in the open water surface compartment. (Continued)

Method	Explanation	Advantages	Limitations	Example of Use
Bulk water sample	<ul style="list-style-type: none"> Sampling large volume of water and reducing volume 	<ul style="list-style-type: none"> Known volume sampled Can sample from vessels of opportunity 	<ul style="list-style-type: none"> Limited volume can be processed, restricting it to smallest litter fractions Volume reducing sample on a working deck may expose sample to contamination 	Song <i>et al.</i> (2014)
Visual observations from a ship	<ul style="list-style-type: none"> Visual survey of floating marine litter from the surface of a vessel at sea Use either fixed width transects (assumes all items seen) or distance sampling (correct for decrease in detection probability with distance from the vessel) 	<ul style="list-style-type: none"> Easy to do from vessels of opportunity Low cost, needs only binoculars (but ideally also a good quality digital SLR camera and telephoto lens) 	<ul style="list-style-type: none"> Limited to waters adjacent to the ship (up to 50 m typically) Bias against dark and subsurface items; white and buoyant items easier to spot Report start/stop observation times, observer effort, and so on to be useful. 	Ryan (2013)
Photographic and aerial surveys	<ul style="list-style-type: none"> Visual survey of floating marine litter from an airplane or drone 	<ul style="list-style-type: none"> Cover large areas; ideal for mega-litter 	<ul style="list-style-type: none"> High cost to charter, expensive photography equipment Limited to macro and mega-plastic, with one study (Doyle <i>et al.</i> 2011) observing items as small as 10 cm Bias against dark and subsurface items 	Doyle <i>et al.</i> (2011)

Source: GESAMP (2019)

Table 4.4 Examples of methods used for sampling plastics in the water column.

Method	Explanation	Advantages	Limitations	Example of use
Bongo nets, or horizontally hauled plankton nets	Cylindrical–conical shaped, often used for mid-water sampling	<ul style="list-style-type: none"> Can be deployed from vessels Can be used at variable depths Use of flow meter allows volume estimate Not weather dependent Paired bongo net allows replicate sampling 	<ul style="list-style-type: none"> Risk of sample contamination of the sample is handled on the vessel deck after each sampling procedure. Under-samples material <500, 110 and 65 µm Vessel speed may need to be restricted 	Doyle <i>et al.</i> (2011)
Underway pumps	Utilizing seawater intake from vessels	<ul style="list-style-type: none"> Can sample a known volume of water over a given time or distance Can control contamination on vessel 	<ul style="list-style-type: none"> Intakes are small and can limit the upper size range Adverse sea states can affect the position of vessels in water, intake depth variable. May be contamination from the sampling apparatus including the hose 	Desorges <i>et al.</i> (2014), Lusher <i>et al.</i> (2014)
Submersible pumps	Deck pump lowered to a known depth	Can sample a known volume of water	<ul style="list-style-type: none"> Vessel needs to be stationary Intakes are small and can limit the upper size range 	Setälä <i>et al.</i> (2016)
Bulk sample	Sampling large volume of water and volume reducing	Known volume	<ul style="list-style-type: none"> Volume reducing sample on a working deck may expose the sample to contamination. Care must be taken 	Song <i>et al.</i> (2014)
CPR	Continuous plankton recorder towed from ships underway	<ul style="list-style-type: none"> Can be used over a large distance from vessels of opportunity Can use archived samples since 1946 	<ul style="list-style-type: none"> Water depth sampled is approximately –10 m, that is, cannot sample surface waters Restricted size of intake may underestimate larger particles 	Thompson <i>et al.</i> (2004)
Fisheries observer	Opportunistic capture of plastic marine litter with towed pelagic fishing gear	<ul style="list-style-type: none"> No equipment necessary. Observing long line fisheries that capture most nets and lines 	<ul style="list-style-type: none"> Water depth sampled is approximately –10 m, that is, cannot sample surface waters Restricted size of intake may underestimate larger particles 	Uhrin (2018)

Source: GESAMP (2019).

- Distance sampling is a statistical approach which is used to compensate for the decline in the detection probability with increasing distance from the ship. It is important to record the distance of each item from the ship with a correction factor for other variables such as size, color, and buoyancy. This method assumes that the distance of items along the transect line is 1 (probability detection items).

Both approaches have advantages and disadvantages. [Suaria *et al.* \(2020\)](#) monitored the abundance of floating macro-plastic using both approaches ([Figure 4.11](#)). They found that both approaches yielded very similar results, which can be used to identify litter hotspots. However, the two methods are not completely equivalent. They specified that the distance sampling technique can provide better information about diversity in sizes and typologies while strip transect is easier and less time consuming with more realistic estimates for the smallest size fractions. This is consistent with the information in the GESAMP that the observation along the transect width can provide a high density of marine litter while the distance method is expected to detect a greater diversity of items.

However, the monitoring program should be consistent with the methods used for the consistency of the monitoring results of the entire program. One major criterion for the visual survey method is the minimum size of the litter which is suggested to be limited to about 25 mm (GESAMP). Aircraft have also been used for visual surveys of marine debris. The floating marine litter can be detected by the crew on the aircraft, and the efficiency highly depends on the experiences of the observers and the condition of the sea. Several factors influence visual surveys, which needs to be considered before launching the monitoring program so that the bias and interference can be eliminated.

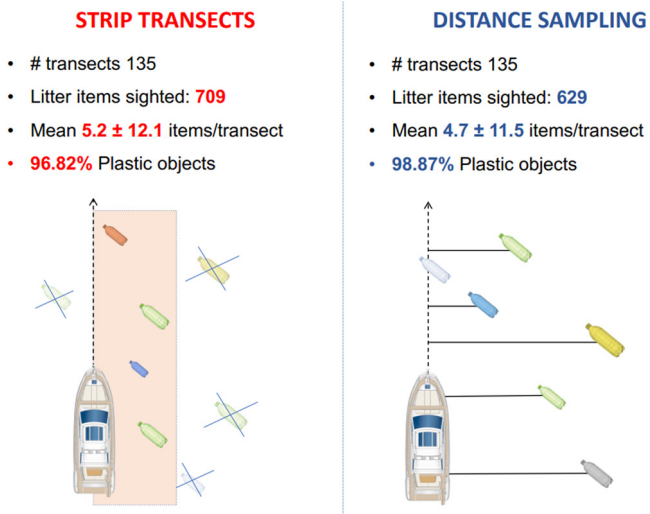

Figure 4.11 Fixed width transect VS distance sampling (Source: [Suaria *et al.*, 2020](#)).

Such factors include the object size, the distance between the objects and the observers in both vertical and horizontal axes, the color and shape, the conditions (submerged or floating) and the ocean condition.

4.2.2.1.2 Net sampling

Using net and trawl is a traditional method that several scientists choose when investigating both macro and microplastics marine plastic litter in water columns. This kind of equipment and technique is adapted from the plankton net. Thus, a monitoring program can be developed with the same equipment as the other monitoring programs, that is, plankton and fisheries monitoring program. The flowmeter is also required to measure the volume of water passing through the equipment to estimate the concentration. It should be noted here however that some limitations should be considered. First, the speed and time of the tows must be limited to avoid clogging of the net (also by zooplankton during nighttime). Also, the net tow should be deployed from the side of the vessel and away from the ship to avoid some contamination and wave disturbance. For a deeper water column, the Bongo net consisting of two large round nets that open and deploy beneath the surface are commonly used.

[Figure 4.12](#) shows the Albatross used for microplastic sampling. The Albatross is a sampling equipment developed by Pirika, Inc. to measure microplastics in different marine environments. The major components of the Albatross include sea scooters, plankton nets, and flow meters. The Albatross has been used in several research studies, including the Kawasaki City study, the 100 Surveys Nationwide, UNEP's CounterMEASURE ([Abeynayaka et al., 2020](#)).

4.2.2.1.3 Bulk water samples

Bulk water sampling is a popular method to obtain samples from the ocean and water bodies. Samples are collected from the water body of interest using a water pump or a container. Then, the water sample is filtered with a sieve (e.g., a pore size of 20–80 μm) or filter paper (e.g., a pore size of 0.45–20 μm). The major limitation of this method is the volume of water collected because small pore filters clog more easily, and the logistic cost when the samples need to be brought back for analysis in the laboratory.

4.2.2.1.4 Continuous plankton recorders

The continuous plankton recorder (CPR) is useful for subsurface plastics sampling over long distances. The CPR ([Figure 4.13](#)) is a plankton sampling instrument designed to be towed from merchant ships, or ships of opportunity, on their normal sailings. The depth of this kind of tool is approximately 10 m. During the data collection process, the band of silk will be slowly moved to trap the plankton and microplastics. To preserve the samples for analysis in the laboratory, a formalin solution is added to the samples. However, the procedure should not be conducted at nighttime so as to eliminate interference from plankton.

[Thompson et al. \(2004\)](#) used CPR survey methods to investigate the emergency events of microplastics in the North Atlantic Ocean in the 1960s using 130 CPR sampling. They found about 89 pieces of microplastics on the



Figure 4.12 The albatross for microplastic sampling in the marine environment (Source: [Abeynayaka et al., 2020](#)).

silk band. Most of them were in the form of microfilaments such as polyester fibers and lines from the fishing gears.

4.2.2.2 Remote sensing surveys and the ocean circulation model

Remote sensing is one of the survey methods used to monitor marine litter, especially in large areas such as the ocean. One major benefit of remote sensing surveys is that there is no need for physical sampling at the actual location (unless the validation of the methods is required). Thus, the cost and time to conduct assessment is lower than that required for conventional methods when the methodology is well developed. Remote sensing surveys utilize various methods and techniques as follows.

- Digital and video cameras: this technique used to improve the accuracy and quality of the sampling data. Moreover, the fixed digital and video cameras attached to the bow of the vessel or aircraft is another

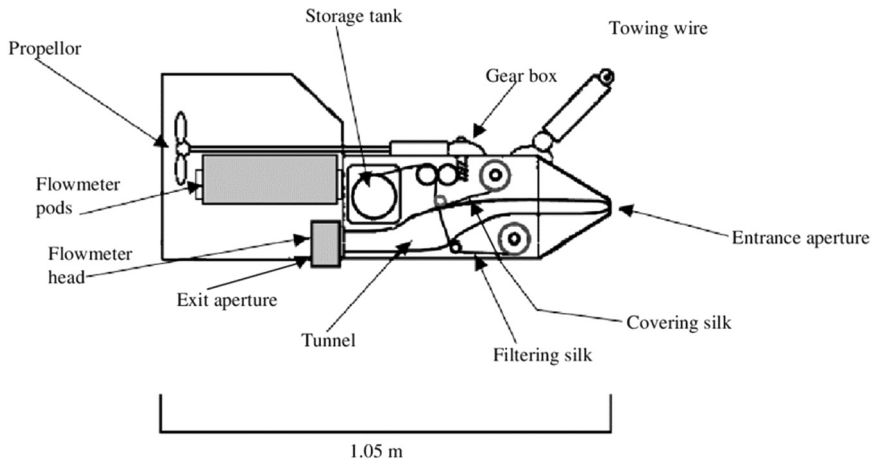

Figure 4.13 Schematic diagram of continuous plankton recorder (CPR) showing the location of the flowmeter (Source: [Jonas et al., 2004](#)).

technique to collect the sample automatically. For example, [Kako et al. \(2012\)](#) conducted a marine debris investigation program using a remote-controlled digital camera attached to the balloon which was filled with helium gas. The camera captured photographs and sent the results back to the ground.

- Infrared camera and light detection and ranging (Lidar): this method captures images of heat radiation which plastic can absorb. Then, the spectra are reflected in near infrared (NIR). The algorithm for the detection of marine debris was developed by Veenstra and Churnside (2012) proposing to combine a multi- or hyperspectral imager with an automated detection algorithm.
- Ocean circulation model: this method can be used to simulate the pathways, accumulation or the sink zone of the marine plastic debris using input data from different sources such as ocean circulation, seasons, and some background plastic concentration. [Zambianchi et al. \(2017\)](#) used the historical Lagrangian model to estimate the probability area that marine debris could accumulate or occur in the subareas of the basin in the Mediterranean Sea.

4.2.3 Plastic debris on the sea floor

The monitoring of litter on the seafloor may not be logistically feasible for all coastal areas because of limited resources and the conditions of the seafloor which are significantly different from one location to another. Thus, the monitoring program should be based on a proper approach for the sampling site.

For macro-size plastics, a comparison in terms of suitable depth, required expertise, and sea bottom types of each method is summarized in [Table 4.5 \(GESAMP, 2019\)](#).

Table 4.5 Comparison of each marine debris on the seafloor monitoring methods.

Protocol	Diving	Trawling	Pole Trawling	ROVs	Microplastics
Maximum depth	30 m	800–1000 m	2500 m	20–6000 m	–
Equipment	Diving equipment	Net	Pole net	ROV/SUB	Grab/corer
Supporting vessel	Small	Large	Small/Large	Small/Large	Small/Large
Maturity (low/medium/high)	H	H	M	M	M (extraction procedures)
Expertise	M	L/M	H	H	H/M
Applicability	Coastal	Shelves and bathyal	Shelves/bathyal/abyssal	Any location, including slopes	Any flat area
Bottom type	Any	Soft bottom	Soft bottom	Any	Soft bottom
Limitations	Depth: depends on accessibility to diving area	Restricted to flat/smooth bottoms	Restricted to flat/smooth bottoms	Expensive unless coupled with existing deep-sea bottom surveys	Spatial representativity
Opportunistic approach	Yes, in MPAs or cleaning operation	Yes	No regular surveys	Yes, recommended	Opportunistic cruises

Source: GESAMP (2019).

For micro-size plastics, sampling sediments can require significantly more effort and resources, depending on the water depth. The observed variations in environmental samples are due to many factors, including local sedimentary dynamics and proximity to point sources (Dris *et al.*, 2015; Lebreton *et al.*, 2017). GESAMP (2019), in their summary of procedures for micro-plastic monitoring and sampling methods for the sediments which depends on the depth of the seafloor (<30 m or >30 m), suggests that sampling with depth of less than 30 m can be conducted by diving while that with depth of more than 30 m can be carried out with the corer from the ship.

4.2.4 Plastic debris information from marine biota

Biota can be used as an indicator of environmental contamination by marine litter which is dependent on the size of plastics. Potential ingestion, entanglement and habitat risks of different plastic wastes and biota are presented in Figure 4.14.

One method used to monitor the microplastic in the marine ecosystem is examining stomach contents of marine life such as birds, turtles, fishes,

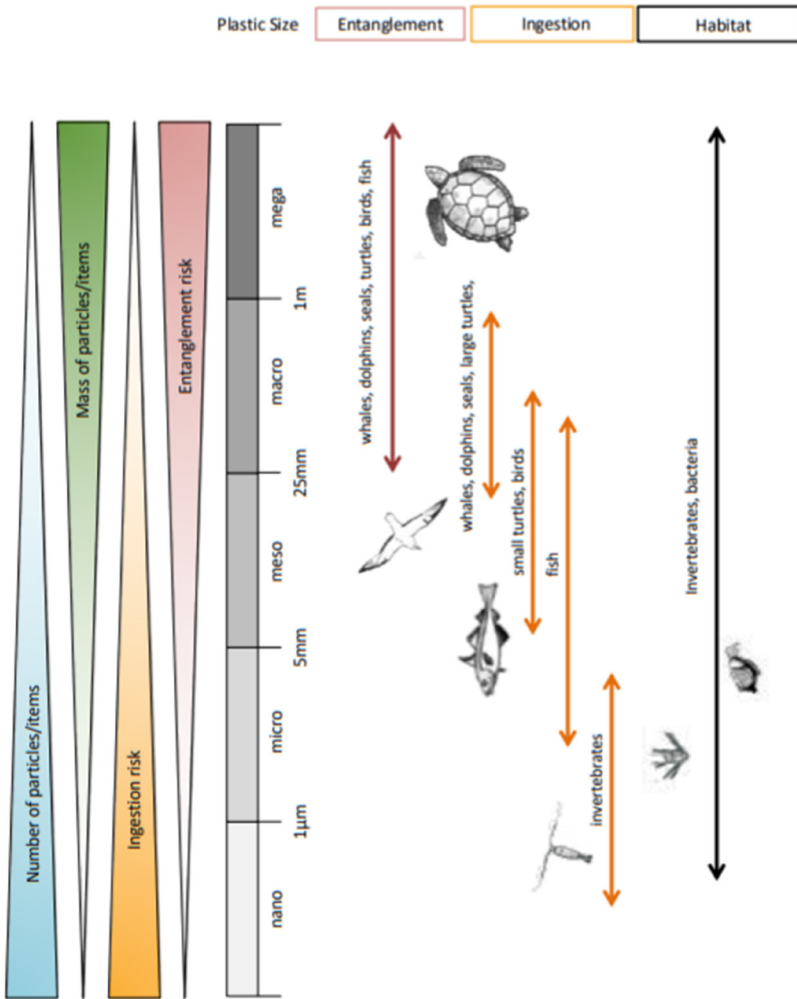

Figure 4.14 Schematic representation of the impact of different size plastics on marine biota, including entanglement, ingestion and habitat associated risk (Source: adapted from [GESAMP, 2015](#)).

crustaceans, shellfishes, worms or zooplankton. Another method is to examine the plastics collected by seabirds for nest construction in colonies on beaches and at the sea surface, and associated entanglement mortality. There are two main approaches through which it is possible to take the samples.

- Taking samples from dead biota which, for example, are either found opportunistically stranded on the shoreline or captured by fisheries operations. Market surveys of where seafood is sold also fall into this category. However, the bias of information toward more plastics may occur in these types of samples.
- Taking samples from, or samples associated with, biota, such as regurgitated pellets, scats, nesting materials, or entangled litter.

4.2.5 Plastic debris in the atmosphere

Microplastic identification consists of several steps including the sampling process, sample preparation, analysis, and detection. The analytical techniques of microplastics collected from various ecosystems are similar while the methods of sample collection are different depending on the sampling sites. Currently, sampling guidelines for atmospheric microplastics have not been proposed by any organizations. Therefore, the sampling methods for airborne particles have been applied to the sampling of microplastics in the air. Currently, there are two methods employed for airborne microplastics sampling which are passive atmospheric deposition and active pumped samplers as shown in [Figure 4.15](#).

4.2.5.1 Passive atmospheric deposition

Most studies ([Abbasi et al., 2019](#); [Dris et al., 2015, 2016](#); [Zhou et al., 2017](#)) in the field of airborne microplastics employed this method. Microplastics in the air are estimated through the presence of microplastics in the total atmospheric fallout which includes wet and dry depositions. [Figure 4.16](#) shows wet and dry samplers used for microplastic deposition study at the Asian Institute of Technology. The

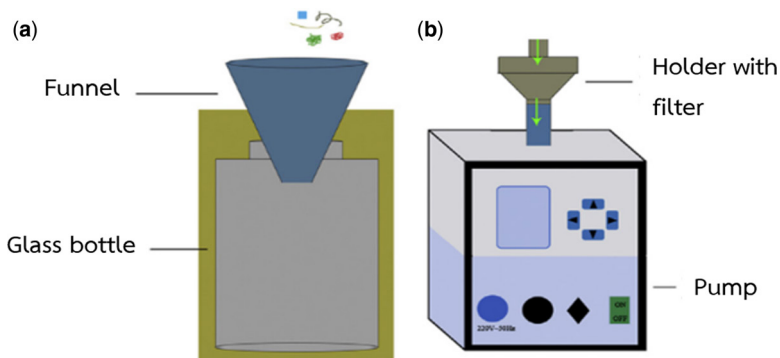

Figure 4.15 Two methods used for atmospheric microplastics sampling. (a) passive atmospheric deposition (b) active pumped samplers (Source: [Chen et al., 2020](#)).



Figure 4.16 Outdoor atmospheric microplastics sampling device at the Asian Institute of Technology. (a) rain sampler component, (b) particulate fallout collector component.

equipment has a sensor to detect rain, and the cover will move to cover the dry deposition part while the rain will be collected on the wet deposition part.

The passive sampling method is considered ideal method sampling atmospheric microplastic deposition due to the ease of use, sample acquisition, and methodology standardization. Moreover, it is suitable for rural areas with no access to power, or for long-term continuous operation on a weekly or monthly basis. The device is placed in an unsheltered location. During the monitoring period, the weather conditions such as the correlation between weather and microplastic deposition should be recorded for further analysis. After collection, the samples are covered to avoid contamination and are stored until the next processing step. The unit of microplastics is usually reported as the number of items per square meter per day. For road and indoor dust, different methods such as vacuum cleaners and brushes have been applied for sampling airborne microplastics. In this case, the samples are vacuumed or swept, and then they are transferred to sample bags for further preparation.

4.2.5.2 Active pumped samplers

Active pumped samplers consist of a pump unit and a holder with filters. The device used in this method includes a stand-alone sampling pump, a vacuum pump or a vacuum cleaner, and an ambient filter sampler as shown in [Figure 4.17](#) (high volume air sampler). The high volume air sampler is successfully used in sampling a known volume of air over defined periods in selected areas, and is commonly used to monitor total suspended particles in ambient air. During the

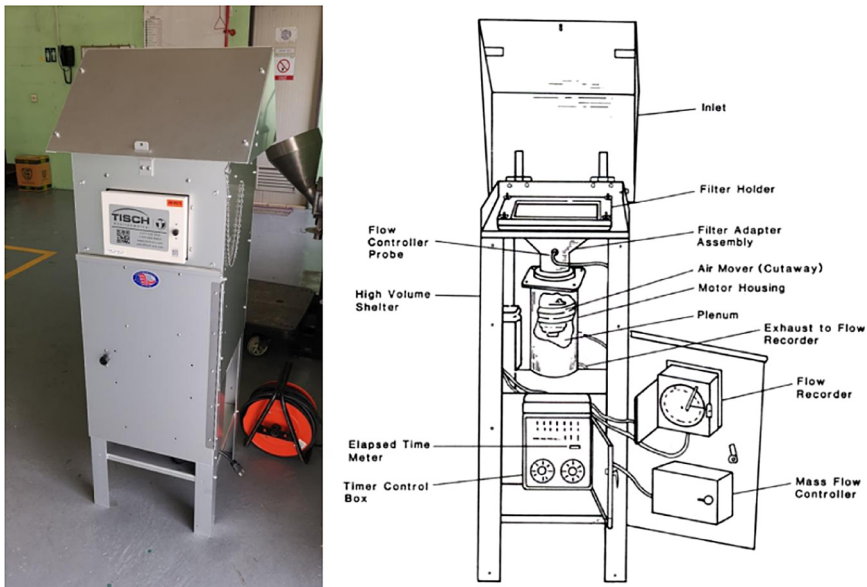

Figure 4.17 High volume sampler used for plastic sampling.

monitoring period, the pump is run continuously, and the weather conditions should be recorded simultaneously. After collection, the samples are transferred to other containers for further analysis. The unit of microplastics collected from this method is expressed as the number of items per cubic meter.

Table 4.6 presents the summary of the methods used in the studies on atmospheric microplastics. The passive sampling method provides a time and

Table 4.6 Analytical methods used in the studies on airborne microplastics.

City	Locations	Surface or Volume	Hight	Sampling Methods	Reference
Paris	University of Paris-Est-Creteil	0.325 m ²	Rooftop	Passive	Dris et al. (2015)
Paris	Urban and sub-urban environments	0.325 m ²	Rooftop	Passive	Dris et al. (2016)
Paris	Outdoor: University of Paris-Est-Creteil Indoor: two apartments and one office	5–20 m ³ in 10–40 h in outdoor and 2–5 m ³ with 8 L/min indoor	Active: 1.2 m for pumping Passive: 1.2 cm height above ground	Passive and active	Dris et al. (2017)
Asaluyeh	15 sites for dust and 16 for suspended dust	Passive: 100 g of street dust Active: 16.67 L/min for 24 h	Active: 3–4 m	Passive and active	Abbasi et al. (2019)
Hamburg	Six stations at different sites	N/A	100 cm above ground level	Passive	Abbasi et al. (2019)
California	Four sampling sites	11.7 L/min for 6–8 h	N/A	Active	Gaston et al. (2020)
London	Riverside urban site	0.03 m ²	50 m	Passive	Wright et al. (2020)
Pyrenees	Bernadouze meteorological station	0.014 m ² and 0.03 m ²	N/A	Passive	Allen et al. (2019)
Dongguan	School, water-works, gym	0.0177 m ²	N/A	Passive	Cai et al. (2017)
Shanghai	Six stations at four sites	6 m ³ with 100 ± 0.1 L/min over 1 h	Three stations at 1.7, 33, and 80 m at one side	Active	Liu et al. (2019)
Beijing	China University of Mining and Technology	5 L/min for 6–8 h	18 and 1.5 m	Active	Li et al. (2020)
Yantai	One site in coastal urban	0.01 m ²	1.8 m	Passive	Zhou et al. (2017)

Source: [Chen et al. \(2020\)](#).

location-specific indication of the quantity of microplastics deposition onto the surface, while the active method provides the estimated microplastics abundance in the air mass rather than deposited microplastics, or the quantity of microplastics in the air that may not deposit. Therefore, to obtain the full picture of airborne microplastics, the use of these two methods is recommended.

For the movement of atmospheric microplastics, the drivers consist of transport, dispersion, and deposition. The air quality dispersion model and the trajectory model can be used to study the dispersion and source of microplastics in the air, similar to the study of particulate matter. However, the diameter, shape, and density of the microplastics may need to be modified in the model.

4.3 PLASTIC IDENTIFICATION METHODS

To study the plastic contamination in the marine environment and design a proper management program, information about the polymer type and the additive content of the plastics is necessary. Identification of plastics can be considered based on physical (shape, density, color, and marking) and chemical (chemical nature of polymers, their degradation products, and additives) properties, and the techniques include methods ranging from low-technology and cost-effective to state-of-the-art analytical techniques.

4.3.1 Marking

In 1998, Resin Identification Code (RIC) was established by The Society of the Plastics Industry (SPI). This kind of system allows the customer and recycler to identify the different types of polymers based on coding 1–7 numbered as shown in [Figure 4.18](#).

The higher the numbers, the more difficult for the plastic type to be recycled after consumption. For example, PET is RIC Code 1, indicating that it is easy to recover and to be used as a raw material for use in postconsumer applications such as fiber, carpeting, bottle, and strapping applications.

4.3.2 Identification of fishing gear

To address the problems of derelict fishing gear, the Food and Agriculture Organization (FAO) of the United Nations established the fishing gear marking to identify the type and location on the tag of fishing gear. Moreover, the MARPOL Annex V Guidelines suggest providing information such as the vessel name, the registration number and nationality on the tag as well ([Figure 4.19](#)). Thus, this can help scientists and governments identify the source of derelict fishing gear.

4.3.3 Shape and form

The shape or form of plastic waste can also be used to indicate the type of plastic. For example, plastic bags are usually made of LDPE, buoys are made of EPS, and cigarette butts are made of cellulose acetate. [Figure 4.20](#) shows simple shapes and forms that can be used to identify plastic types.

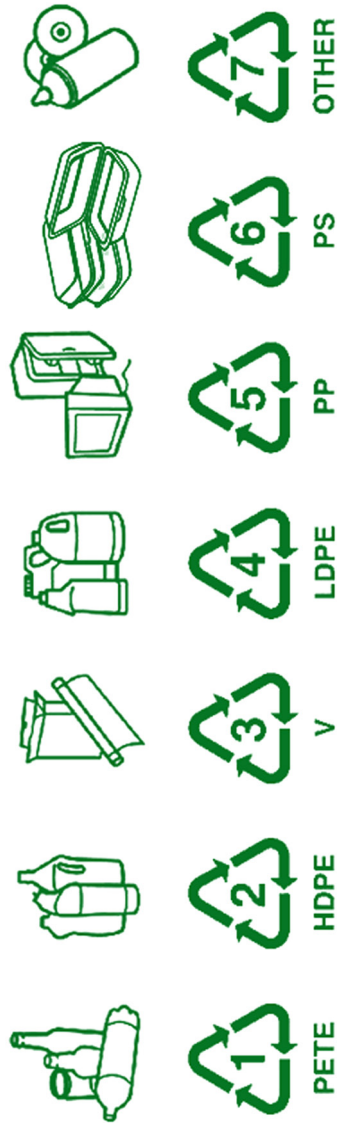

Figure 4.18 Resin identification codes. *PETE*, poly (ethylene terephthalate); *HDPE*, high-density polyethylene; *V* (or *PVC*), poly (vinyl chloride); *LDPE*, low-density polyethylene; *PP*, polypropylene; *PS*, polystyrene (Source: [Deshpande, 2020](#)).



Figure 4.19 Experimental labeling of fishing gear from the project with small fishing communities in Indonesia (Source: FAO, 2021).

Symbol	Description	
 PETE	Clear tough plastic such as soft drink, juice and water bottles.	
 HDPE	Common white or coloured plastic such as milk containers and shampoo bottles.	
 V	Hard rigid clear plastic such as cordial bottles.	
 LDPE	Soft flexible plastic e.g. squeezable bottles such as sauce bottles.	
 PP	Hard but flexible plastic such as microwave ware, takeaway containers, some yoghurt/ice cream/jam containers, hinged lunch boxes.	
 PS	Rigid, brittle plastic such as small tubs and margarine/butter containers.	
 OTHER	All other plastics, including acrylic and nylon. Examples include some sports drink bottles, sunglasses, large water cooler bottles.	

Figure 4.20 Example of plastic identification based on shape and form (Source: He, 2018).

4.3.4 Density

Density identification method is based on the fact that different plastics have different densities, and this affects separation in float–sink tanks. The plastic which has a density less than that of water will float while that with higher density will sink. For this method, various solutions (such as water or ethanol) with different densities can be used to separate different types of plastics in the sample. The densities of different polymers (plastics) are summarized in [Table 4.7](#).

Table 4.7 Density of some plastic materials and polymers.

Room temperature density values for polymers

Material	Density	
	g/cm ³	lb _m /in ³
ABS, extrusion grade	1.052	0.038
ABS, high impact	1.024	0.037
Acetal, 20% glass	1.550	0.056
Acetal, copolymer	1.412	0.051
Acetal, homopolymer	1.412	0.051
Acrylic	1.190	0.043
Butadiene – acrylonitrile (nitrile)	0.98	0.0354
CPVC	1.550	0.056
Epoxy	1.11–1.40	0.0401–0.0505
Fiberglass sheet	1.855	0.067
Styrene – butadiene (SBR)	0.94	0.0339
Silicone	1.1–1.6	0.040–0.058
Nylon 6, 30% glass	1.384	0.050
Nylon 6, cast	1.163	0.042
Nylon 6/6 cast	1.301	0.047
Nylon 6/6 extruded	1.135	0.041
PVC (polyvinyl chloride)	1.384	0.050
PVDF (polyvinylidene fluoride)	1.772	0.064
Phenolic	1.28	0.0462
Polybutylene terephthalate (PBT)	1.34	0.0484
Polycarbonate (PC)	1.20	0.0433
Polyester (thermoset)	1.04–1.46	0.038–0.053
Polyetheretherketone (PEEK)	1.31	0.0473
Low-density polyethylene (LDPE)	0.925	0.0334
High-density polyethylene (HDPE)	0.959	0.0346
Ultra-high molecular weight polyethylene (UHMWPE)	0.94	0.0339
Polypropylene (PP)	0.905	0.0327
Polytetrafluoroethylene (PTFE)	2.17	0.0783
Polyurethane	1.052	0.038

Source: [Callister and Rethwisch \(2018\)](#).

Some studies have found differences in the density of fresh plastics on beaches and plastics in the open ocean. This clearly indicates that the length of time during which plastic debris remains in the sea has an influence on its weight due to the biofouling from the biomass and marine organism.

4.3.5 Color

Color is a simple characteristic of plastic that can be used to roughly identify the chemical composition of plastic debris in the marine environment. For example, a clear and transparent plastic fragment can be identified as polypropylene (PP) whereas opaque white plastics can be labeled as polyethylene (PE). Moreover, to identify photodegradation and exposure time of marine plastic debris, the discoloration can be used as an index. Discoloration or yellowing is related to the concentration of polychlorinated biphenyls (PCBs). The plastic, which contains a high concentration of PCBs, has a higher chance of getting discolored than that with low concentration because the sea water is a catalyst of oxidation reaction in PCBs plastic waste. Furthermore, for both polycyclic aromatic hydrocarbons and PCBs, black and aged pellets possess the greatest diversity of adsorbed contaminants.

4.3.6 Burn test

The burn test is a simple and effective method used to identify plastic polymers in a timely and cost-effective manner. The method is based on the polymer's flame and smoke characteristics during combustion. The characteristics of each type of polymer during burning are provided in [Table 4.8](#).

4.3.7 Microscopic identification

This method uses a microscope to measure the size and shape of the microplastics. The information acquired from this process depends highly on the type of microscope used. Different techniques (such as hot needle technique) and the expertise of the observers determine the accuracy of microplastics identification. [Figure 4.21](#) shows examples of photographs taken from the microscopic examination which can be used to identify the size, shape, and color of the microplastics in the sample.

Table 4.8 Characteristics of each type of polymer during burn test.

Polymer	Behavior
PETE	Melts and bubbles first; burns slowly with some black soot; pungent odor of acetaldehyde
HDPE	Burns rapidly and cleanly; drips flames; white smoke when extinguished
PVC	Melts; may burn, but extinguishes upon removal from the flame
LDPE	Burns rapidly and cleanly; drips flames; white smoke when extinguished
PP	Burns slower than PE; may drip flames
PS	Burns rapidly; large amounts of black soot

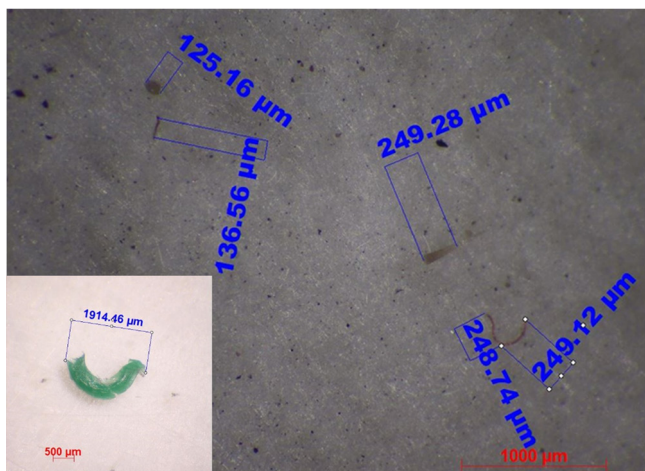

Figure 4.21 Examples of photographs taken from the microscopic examination.

4.3.8 Infrared spectroscopy

This method compares an unidentified plastic sample's infrared spectrum with that of known polymers. Infrared spectroscopy (IR), Fourier transform infrared spectroscopy (FTIR), and NIR spectroscopy are the types of IR spectroscopy used for identification, especially for microplastics.

FTIR technology is a popular method which is used to identify the types of polymers of plastic fragments in the open ocean. It is a form of spectroscopy vibration which depends on the absorbance, transmittance, or reflectance of infrared light. The spectrum of unidentified plastic debris fragment sampling is compared to the reference spectra of an infrared library database based on the vibrational frequencies of the bonds in the sample. Thus, it can be used to classify the different types of polymers on unknown samplings that are collected from the source. [Figure 4.22](#) provides an example of FTIR results of microplastics in the air environment.

4.3.9 Pyrolysis–gas chromatography/mass spectrometry (Pyr-GC/MS)

The key benefit of Pyr-GC/MS which FTIR lacks is that polymer forms and organic plastic additives (OPAs) can also be analyzed in a single run. It is also possible to identify the signature of known synthetic polymers, which can provide additional information on marine plastic's source and transport. On the other hand, the key drawbacks are the high cost of analytical instruments and the relatively large amount of sample needed for each analysis, which is not indicative of a heterogeneous marine sample made up of several synthetic polymers from various sources.

4.3.10 Raman spectroscopy

Raman spectroscopy is a spectroscopic technique used to observe low-frequency modes of materials such as vibrations and rotations among others.

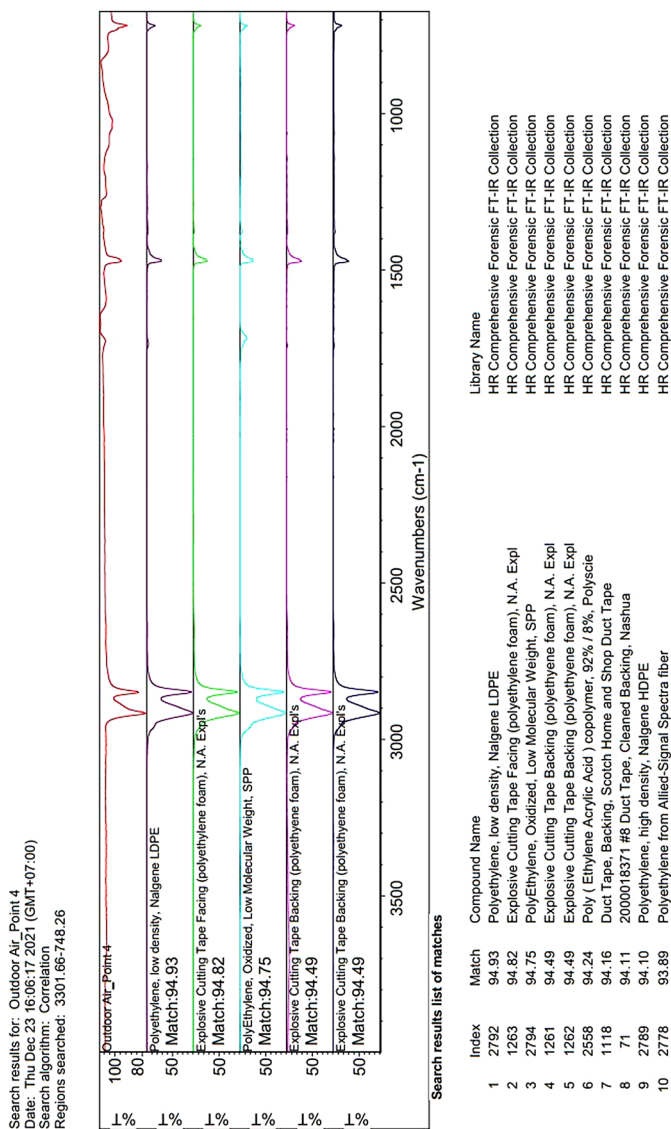

Figure 4.22 Example of microplastic examination by FTIR from the air sample.

This is based on the inelastic scattering of monochromatic light, typically from a laser in the visible, near-infrared, or near-ultraviolet range, which gives the tested materials a molecular fingerprint. The most common plastic forms found in the marine environment are PE, PP, have been identified using Raman spectra from biodegraded samples. Nonpolar and symmetric bonds react better to Raman spectroscopy, while polar groups can be identified more clearly with FTIR.

REFERENCES

- Abbasi S., Keshavarzi B., Moore F., Turner A., Kelly F. J., Dominguez A. O. and Jaafarzadeh N. (2019). Distribution and potential health impacts of microplastics and microrubbers in air and street dusts from Asaluyeh County, Iran. *Environmental Pollution*, **244**, 153–164, <https://doi.org/10.1016/j.envpol.2018.10.039>
- Abeynayaka A., Kojima F., Miwa Y., Ito N., Nihei Y., Fukunaga Y., ... Itsubo, N. (2020). Rapid sampling of suspended and floating microplastics in challenging riverine and coastal water environments in Japan. *Water*, **12**(7), 1903.
- Acuña-Ruz T., Uribe D., Taylor R., Amézquita L., Guzmán M. C., Merrill, J., ... Mattar, C. (2018). Anthropogenic marine debris over beaches: spectral characterization for remote sensing applications. *Remote Sensing of Environment*, **217**, 309–322.
- Allen S., Allen D., Phoenix V. R., Le Roux G., Jiménez P. D., Simonneau A., Binet S. and Galop D. (2019). Atmospheric transport and deposition of microplastics in a remote mountain catchment. *Nature Geoscience*, **12**(5), 339–344, <https://doi.org/10.1038/s41561-019-0335-5>
- Biermann, L., Clewley, D., Martínez-Vicente, V. and Topouzelis, K. (2020). Finding plastic patches in coastal waters using optical satellite data. *Scientific Reports*, **10**(1), 1–10, <https://doi.org/10.1038/s41598-020-62298-z>
- Bour A., Avio C. G., Gorbi S., Regoli F. and Hylland K. (2018). Presence of microplastics in benthic and epibenthic organisms: Influence of habitat, feeding mode and trophic level. *Environmental Pollution*, **243**, 1217–1225.
- Cai L., Wang J., Peng J., Tan Z., Zhan Z., Tan X. and Chen Q. (2017). Characteristic of microplastics in the atmospheric fallout from Dongguan city, China: preliminary research and first evidence. *Environmental Science and Pollution Research*, **24**(32), 24928–24935, <https://doi.org/10.1007/s11356-017-0116-x>
- Callister, W. D. and Rethwisch, D. G. (2018). *Materials Science and Engineering: an Introduction* (Vol. 9, pp. 96–98). Wiley, New York.
- Chen G., Fu Z., Yang H. and Wang J. (2020). An overview of analytical methods for detecting microplastics in the atmosphere. *TrAC Trends in Analytical Chemistry*, **130**, 115981, <https://doi.org/10.1016/j.trac.2020.115981>
- Currie D. J., Smith C. and Jagals P. (2018). The application of system dynamics modelling to environmental health decision-making and policy – a scoping review. *BMC Public Health*, **18**, 402. <https://doi.org/10.1186/s12889-018-5318-8>
- Deidun A., Gauci A., Lagorio S. and Galgani F. (2018). Optimising beached litter monitoring protocols through aerial imagery. *Marine Pollution Bulletin*, **131**, 212–217.
- Desforges J. P. W., Galbraith M., Dangerfield N. and Ross P. S. (2014). Widespread distribution of microplastics in subsurface seawater in the NE Pacific Ocean. *Marine Pollution Bulletin*, **79**(1–2), 94–99.
- Deshpande, A. (2020). Different Plastics. <https://www.recharkha.org/blogs/blog/different-kinds-of-plastic-where-you-will-find-them> (accessed 10 December 2020).
- Doyle M. J., Watson W., Bowlin N. M. and Sheavly S. B. (2011). Plastic particles in coastal pelagic ecosystems of the Northeast Pacific ocean. *Marine Environmental Research*, **71**(1), 41–52.

- Dris R., Gasperi J., Rocher V., Saad M., Renault N. and Tassin B. (2015). Microplastic contamination in an urban area: a case study in Greater Paris. *Environmental Chemistry*, **12**(5), 592–599, <https://doi.org/10.1071/EN14167>
- Dris R., Gasperi J., Saad M., Mirande C. and Tassin B. (2016). Synthetic fibers in atmospheric fallout: a source of microplastics in the environment? *Marine Pollution Bulletin*, **104**(1–2), 290–293, <https://doi.org/10.1016/j.marpolbul.2016.01.006>
- Dris R., Gasperi J., Mirande C., Mandin C., Guerrouache M., Langlois V. and Tassin B. (2017). A first overview of textile fibers, including microplastics, in indoor and outdoor environments. *Environmental Pollution*, **221**, 453–458, <https://doi.org/10.1016/j.envpol.2016.12.013>
- Eriksen M., Lebreton L. C., Carson H. S., Thiel M., Moore C. J., Borerro J. C., ... Reisser, J. (2014). Plastic pollution in the world's oceans: more than 5 trillion plastic pieces weighing over 250,000 tons afloat at sea. *PLoS One*, **9**(12), e111913.
- FAO. (2021). Responsible Fishing Practices for Sustainable Fisheries. <https://www.fao.org/responsible-fishing/marking-of-fishing-gear/voluntary-guidelines-marking-fishing-gear/en/> (accessed 12 December 2021).
- Fleet D., Vlachogianni Th. and Hanke G., 2021. A Joint List of Litter Categories for Marine Macrolitter Monitoring. EUR 30348 EN, Publications Office of the European Union, Luxembourg, 2021. ISBN 978-92-76-21445-8. <https://doi.org/10.2760/127473,JRC121708>
- Gaston E., Woo M., Steele C., Sukumaran S. and Anderson S. (2020). Microplastics differ between indoor and outdoor air masses: insights from multiple microscopy methodologies. *Applied Spectroscopy*, **74**(9), 1079–1098, <https://doi.org/10.1177/0003702820920652>
- GESAMP (2015). *Sources, fate and effects of microplastics in the marine environment: a global assessment* (Kershaw P.J. editor), (IMO/FAO/UNESCO-IOC/UNIDO/WMO/IAEA/UN/UNEP/UNDP Joint Group of Experts on the Scientific Aspects of Marine Environmental Protection). Rep. Stud. GESAMP No. 90, 96 p.
- GESAMP (2016). *Sources, fate and effects of microplastics in the marine environment: part two of a global assessment* (Kershaw P.J. and Rochman C.M. editors), (IMO/FAO/UNESCO-IOC/UNIDO/WMO/IAEA/UN/UNEP/UNDP Joint Group of Experts on the Scientific Aspects of Marine Environmental Protection). Rep. Stud. GESAMP No. 93, 220 p.
- GESAMP (2019). Guidelines or the monitoring and assessment of plastic litter and microplastics in the ocean (Kershaw P.J., Turra A. and Galgani F. editors), (IMO/FAO/UNESCO-IOC/UNIDO/WMO/IAEA/UN/UNEP/UNDP/ISA Joint Group of Experts on the Scientific Aspects of Marine Environmental Protection). Rep. Stud. GESAMP No. 99, 130p.
- Gunasekara, K. (2019). Towards the development of a Regional Model for Plastic Leakage. SEA of Solution: partnership Week for Marine Plastic Pollution Prevention. http://sos2019.sea-circular.org/wp-content/uploads/2019/11/Parallel-session-3_-_Towards-better-data_Kavinda.pdf (accessed 20 December 2021).
- Gutow L., Bartl K., Saborowski R. and Beermann J. (2019). Gastropod pedal mucus retains microplastics and promotes the uptake of particles by marine periwinkles. *Environmental Pollution*, **246**, 688–696, <https://doi.org/10.1016/j.envpol.2018.12.097>
- Hanke G., Galgani F., Werner S., Oosterbaan L., Nilsson P., Fleet D., ... Liebezeit, G. (2013). Guidance on Monitoring of Marine Litter in European Seas: a guidance document within the Common Implementation Strategy for the Marine Strategy Framework Directive.
- Hardesty B. D., Schuyler Q., Lawson T. J., Opie K. and Wilcox, C. (2016). Understanding debris sources and transport from the coastal margin to the ocean. Final Report to the National Packaging Covenant Industry Association, p-EP165651.

- Hardesty B. D., Harari J., Isobe A., Lebreton L., Maximenko N., Potemra J., ... Wilcox, C. (2017). Using numerical model simulations to improve the understanding of microplastic distribution and pathways in the marine environment. *Frontiers in Marine Science*, **4**, 30.
- He X.-F. (2018, April 19). Planet Earth or Planet Plastic? Possibility. <https://possibility.teledyneimaging.com/planet-earth-or-planet-plastic/>
- Hidalgo-Ruz V. and Thiel, M. (2015). The contribution of citizen scientists to the monitoring of marine litter. *Marine Anthropogenic Litter*, **16**, 429–447.
- Hutto R. L. and Belote, R. T. (2013). Distinguishing four types of monitoring based on the questions they address. *Forest Ecology and Management*, **289**, 183–189.
- Jonas T. D., Walne A., Beaugrand G., Gregory L. and Hays G. C. (2004). The volume of water filtered by a Continuous Plankton Recorder sample: the effect of ship speed. *Journal of Plankton Research*, **26**(12), 1499–1506, <https://doi.org/10.1093/plankt/fbh137>
- Kako S. I., Isobe A. and Magome S. (2012). Low altitude remote-sensing method to monitor marine and beach litter of various colors using a balloon equipped with a digital camera. *Marine Pollution Bulletin*, **64**(6), 1156–1162, <https://doi.org/10.1016/j.marpolbul.2012.03.024>
- Lebreton L., Slat B., Ferrari F., Sainte-Rose B., Aitken J., Marthouse R., ... Reisser, J. (2018). Evidence that the Great Pacific Garbage Patch is rapidly accumulating plastic. *Scientific Reports*, **8**(1), 1–15.
- Lebreton L., Van Der Zwet J., Damsteeg J. W., Slat B., Andrady A. and Reisser J. (2017). River plastic emissions to the world's oceans. *Nature Communications*, **8**(1), 1–10.
- Li Y., Shao L., Wang W., Zhang M., Feng X., Li W. and Zhang D. (2020). Airborne fiber particles: types, size and concentration observed in Beijing. *Science of the Total Environment*, **705**, 135967, <https://doi.org/10.1016/j.scitotenv.2019.135967>
- Lippiatt S., Opfer S. and Arthur C. (2013). Marine debris monitoring and assessment. NOAA Technical Memorandum NOS-OR&R-46, 82.
- Liu K., Wang X., Fang T., Xu P., Zhu L. and Li D. (2019). Source and potential risk assessment of suspended atmospheric microplastics in Shanghai. *Science of the Total Environment*, **675**, 462–471, <https://doi.org/10.1016/j.scitotenv.2019.04.110>
- Lusher A. L., Burke A., O'Connor I. and Officer R. (2014). Microplastic pollution in the Northeast Atlantic Ocean: validated and opportunistic sampling. *Marine Pollution Bulletin*, **88**(1–2), 325–333.
- Lusher A. L., Hernandez-Milian G., Berrow S., Rogan E. and O'Connor, I. (2018). Incidence of marine debris in cetaceans stranded and bycaught in Ireland: recent findings and a review of historical knowledge. *Environmental Pollution*, **232**, 467–476.
- Mace, T. H. (2012). At-sea detection of marine debris: overview of technologies, processes, issues, and options. *Marine Pollution Bulletin*, **65**(1–3), 23–27.
- Moy K., Neilson B., Chung A., Meadows A., Castrence M., Ambagis S. and Davidson K. (2018). Mapping coastal marine debris using aerial imagery and spatial analysis. *Marine Pollution Bulletin*, **132**, 52–59.
- Nakashima E., Isobe A., Magome S., Kako S. I. and Deki N. (2011). Using aerial photography and in situ measurements to estimate the quantity of macro-litter on beaches. *Marine Pollution Bulletin*, **62**(4), 762–769.
- Ng K. (2019, December 2). Whale found dead with 100kg 'litter ball' in stomach. The Independent. <https://www.independent.co.uk/climate-change/news/whale-dead-100kg-litter-ball-stomach-scotland-a9229111.html>
- OSPAR Commission (2010). OSPAR Guideline for Monitoring Marine Litter on the Beach in the OSPAR Maritime Area (Edition 1.0.), Agreement Number 2010–02 (2010), p. 84.

- Ryan P. (2013). Toxic waste: oceans of plastic threaten seabirds. *African Birdlife*, 52–56.
- Setälä O., Magnusson K., Lehtiniemi M. and Norén, F. (2016). Distribution and abundance of surface water microlitter in the Baltic Sea: a comparison of two sampling methods. *Marine Pollution Bulletin*, **110**(1), 177–183.
- Song Y. K., Hong S. H., Jang M., Kang J. H., Kwon O. Y., Han, G. M. and Shim, W. J. (2014). Large accumulation of micro-sized synthetic polymer particles in the sea surface microlayer. *Environmental Science & Technology*, **48**(16), 9014–9021.
- Suaria G., Perold V., Lee J. R., Lebouard F., Aliani S. and Ryan, P. G. (2020). Floating macro-and microplastics around the Southern Ocean: results from the Antarctic Circumnavigation Expedition. *Environment International*, **136**, 105494.
- Themistocleous K., Papoutsas C., Michaelides S. and Hadjimitsis D. (2020). Investigating detection of floating plastic litter from space using sentinel-2 imagery. *Remote Sensing*, **12**(16), 2648.
- Thompson R. C., Olsen Y., Mitchell R. P., Davis A., Rowland S. J., John A. W., ... Russell A. E. (2004). Lost at sea: where is all the plastic?. *Science*, **304**(5672), 838–838.
- UNEP (2009). Marine Litter: a Global Challenge. UNEP, Nairobi, 232 pp.
- UNEP (2016). Marine Plastic Debris and Microplastics – Global Lessons and Research to Inspire Action and Guide Policy Change. United Nations Environment Programme, Nairobi.
- Veenstra T. S. and Churnside J. H. (2012). Airborne sensors for detecting large marine debris at sea. *Marine Pollution Bulletin*, **65**(1–3), 63–68.
- Viršek M. K., Palatinus A., Koren Š., Peterlin M., Horvat P. and Kržan, A. (2016). Protocol for microplastics sampling on the sea surface and sample analysis. *JoVE (Journal of Visualized Experiments)*, (118), e55161.
- Wright S. L., Ulke J., Font A., Chan K. L. A. and Kelly F. J. (2020). Atmospheric microplastic deposition in an urban environment and an evaluation of transport. *Environment International*, **136**, 105411, <https://doi.org/10.1016/j.envint.2019.105411>
- Zambianchi E., Trani M. and Falco P. (2017). Lagrangian transport of marine litter in the Mediterranean Sea. *Frontiers in Environmental Science*, **5**, 5, <https://doi.org/10.3389/fenvs.2017.00005>
- Zettler E. R., Mincer T. J. and Amaral-Zettler L. A. (2013). Life in the “plastisphere”: microbial communities on plastic marine debris. *Environmental Science & Technology*, **47**(13), 7137–7146, <https://doi.org/10.1021/es401288x>
- Zhou Q., Tian C. and Luo Y. (2017). Various forms and deposition fluxes of microplastics identified in the coastal urban atmosphere. *Chinese Science Bulletin*, **62**(33), 3902–3909, <https://doi.org/10.1360/N972017-00956>

ANNEX A

Sample Data Sheet for Data Collection/Survey
UNEP/IOC Guidelines on Survey and Monitoring of Marine Litter

BEACH LITTER	Organization	Name of the organization responsible for collecting the data
Beach Data Sheet BR01	Surveyor name	Name of the surveyor (person responsible for filling in this sheet)
	Phone number	Phone contact for surveyor
Completed ONCE for each site	Date	Date of this update to the data

SAMPLING AREA

BeachID	Unique identity code for the beach (office use only)
Beach name	Name by which the beach is commonly known
Region name	Name for the region (office use only)
LME	Name for the LME in which the beach is located (office use only)
Co-ordinate system	Datum and coordinate system used to record latitude and longitude

BEACH CHARACTERISTICS – considered from the start point of the transect

Total beach length	Length measured along the mid-point of the beach (kilometres)
Substratum type	Defines whether predominantly a sandy or gravel beach (pebble, rock etc.)
Substrate uniformity	An indication of the coverage by the predominant substrate type (percent)
Tidal range	Max – min vertical tidal range (meters)
Tidal distance	Horizontal distance (meters) from the lowest tide to back of the beach
Back of beach	Describe the landward limit (rock wall, cliff, dune, anthropogenic)

SOURCE CHARACTERISTICS – considered from the start point of the transect

Location and major beach usage	URBAN PERI-URBAN RURAL	Select one and indicate the major usage type (swimming and sunbathing, fishing, surfing, boat access or remote).
Access		Vehicular (can drive on beach), pedestrian (must walk), isolated (i.e. need a vessel)

Nearest town			Name of nearest town
Nearest town distance			Distance to the nearest town (kilometres)
Nearest town direction			Direction to the nearest town (degrees)
Nearest river name			Name of nearest river (if relevant) – a null value is assumed to mean no inputs to this location
Nearest river distance			Distance to the nearest river (or stream) (kilometres)
Nearest river direction			Direction to the nearest river or stream (degrees)
River/creek input to beach	YES	NO	Whether the nearest river or stream has an outlet directly to this beach (yes/no)
Pipes or drains input	YES	NO	Distance and direction probably (yes/no)

Other notes

BEACH LITTER Sample AND Beach litter data BR02	Organization Surveyor Name Contact Region Beach ID	Organization responsible for the survey Name of the surveyor (person responsible for filling in this sheet) Phone contact for surveyor Name for the region Unique identity code for the beach (office use only)
---	--	---

Sample unit information

Beach name	Unique name by which the beach is known
Latitude/ longitude start	Recorded as nnn.nnnnn degrees at the start of the sample – indicate NSEW
Latitude/ longitude end	Recorded as nnn.nnnnn degrees at the end of the sample – indicate NSEW
Coordinate system	Datum and coordinate system for latitude and longitude
Sample date	Date sampling was started for the sample (generally today's date)
Time start/end	Time taken to complete the survey (h)
Season	Spring, summer, autumn, winter, NE monsoon and so on
Date of last survey	Date on which the beach was last cleaned either by survey or maintenance clean up
Storm activity	Has there been any significant storm activity since the last survey
Number of persons	Number of persons collecting litter
Length of beach being surveyed	Length of sample unit along the beach (m)
Width of beach	Width of beach at the time of survey (m)
Large items	Add each new item on the sheet provided

LITTER DATA (continue over page if more space required)

Item Code (standard	Description	Count (# items)	Weight (kg)	Item Code (standard list)	Description	Count (# items)	Weight (kg)
------------------------	-------------	--------------------	----------------	---------------------------------	-------------	--------------------	----------------

LITTER DATA (continue over page if more space required)

Item code (standard list)	Description	Count (# items)	Weight (kg)	Item code (standard list)	Description	Count (# items)	Weight (kg)
---------------------------------	-------------	--------------------	----------------	---------------------------------	-------------	--------------------	----------------

Notes

Marine LITTER	Organization	Name of the organization responsible for collecting the data
Large Items Data Sheet	Surveyor name	Name of the surveyor (person responsible for filling in this sheet)
ML01	Contact	Phone contact for surveyor
Use only for items that were not collected.	Date	Collection date for this data
	Region name	Name for the region
Complete survey data at top of form and then ONE row for EACH ITEM.	Location ID	Unique code for the location
	Coordinate system	Used for all GPS data on this page – provide datum and format

LARGE ITEM DESCRIPTION

Item type (if possible, use standard codes)	Status (floating, sunken, stranded, buried)	Latitude (nnn.nnnnn NS)	Longitude (nnn.nnnnn EW)	Description
--	--	--------------------------------	---------------------------------	--------------------

Chapter 5

Circular economy for plastic waste management

Pawan Kumar Srikanth and Chettiyappan Visvanathan

Table of Contents

5.1	Introduction	186
5.1.1	Introduction to plastics and plastic types	186
5.1.2	Plastic wastes	187
5.1.3	Plastic pollution and climate change interactions	190
5.1.4	Plastic waste management options	191
5.2	Circular Economy: A Tool for Plastic Waste Management	192
5.2.1	Elements of CE	194
5.2.2	Design for sustainability	194
5.2.3	Extended producer responsibility	200
5.2.4	Smart plastic waste management systems: role of artificial intelligence	201
5.2.5	CE and 3Rs in plastic waste management	205
5.2.6	Product as a service	210
5.3	Policies Related to Plastic Waste Management	210
5.3.1	Different instruments for influencing plastic consumption	210
5.3.2	Unintended consequences, weak implementation and rebound effect	213
5.3.3	Information instruments	214
5.4	Sustainable Public Procurement to Promote CE	214
5.4.1	Dimensions of sustainable public procurement	215
5.4.2	Plastic disclosure projects	217
5.4.3	Barriers to circular economy	219
5.5	Conclusion	220
	References	220

© 2023 The Authors. This is an Open Access book chapter distributed under a Creative Commons Attribution Non Commercial 4.0 International License (CC BY-NC 4.0), (<https://creativecommons.org/licenses/by-nc/4.0/>). The chapter is from the book *Marine Plastics Abatement: Volume 1. Challenges, Implications, Assessments and Circularity*, Thammarat Koottatep, Ekborderin Winijkul, Wenchao Xue, Atitaya Panuvatvanich, Chettiyappan Visvanathan, Tatchai Pussayanavin, Nantamol Limphitakphong and Chongrak Polprasert (Eds).

5.1 INTRODUCTION

The world is built on circular systems. Life forms on earth return to nature at the end of their life cycle. Over years of evolution, nature has cyclically augmented various process components. The biodegradation of products is a key aspect of natural processes. The meaning of the word 'biodegradable' can be broken down to 'bio' meaning that the product is influenced by biological organisms such as fungi and bacteria which digest the materials, and 'degradable' meaning that the product is catabolized into carbon dioxide, water and oxygen. For example, a banana is made up of organic components consisting of simple peptide bonds which microbes degrade with ease. On the other hand, the same cannot be said about plastics, one of the most popular materials invented during the 20th century, dominating human industrial systems. The first fully synthetic plastic 'Bakelite' was invented in 1907 in New York by Leo Baekeland. Plastics are organic materials that are highly resistant to microbial action due to the strong carbon-carbon bonds. Chemically, most plastics are derived from propylene, a simple chemical constituent of petroleum. In the presence of a catalyst, the simple monomeric units of propylene bond with a strong carbon-carbon bond to form polypropylene. It takes more than 400–500 years for the microbes to degrade it. Hence, it is obvious that all the mismanaged plastic waste is still in existence (Andrady & Neal, 2009). The dominant use of single-use plastic products (SUPP) is observed in the packaging sector.

5.1.1 Introduction to plastics and plastic types

The physical properties of plastics such as plasticity, adaptability, lightweight, durability, flexibility and cost-effectiveness have led to their widespread use across continents for a multitude of purposes. The overall nomenclature of plastics is given in Figure 5.1. Typically, plastics are grouped into two polymer families: thermoplastics and thermosetting plastics. However, new plastic applications, technology development and complexity brought changes in plastics categorization.

Box 5.1 Extensive use of plastics in the aviation industry

Plastics provide design versatility owing to its high strength-to-weight ratio, durability at a low cost, stiffness, toughness and high thermal/electrical insulation, and is very resource-efficient. Public and private transportations contain 20% plastics, typically in the form of parcel shelves, door liners and steering wheels. Owing to its lightweight nature, plastics reduce transportation costs and, therefore, reduce atmospheric carbon dioxide emissions.

The Boeing Dreamliner is designed from up to 50% carbon fibre-reinforced plastics and other composites. Plastics used on the exterior of aircrafts have high resistance to pressurized water, steam, radiation and extreme temperatures. The aeroplane panels are made from acrylonitrile

butadiene styrene (ABS), as it has a lightweight density coupled with impressive strength. Boeing's eco-design and comfort approach is made possible by the switch to carbon-fibre-reinforced plastic for large parts such as the fuselage and wings. The material creates a structure that is light and strong, cutting flying costs and avoiding maintenance expenses associated with corrosion. The plastic fuselage allows bigger windows, and the cabin can be more pressurized with higher humidity, bypassing the dry-mouth effect on long flights.

Source: Industry Today – Plastics and Packaging in the Aerospace Industry <https://industrytoday.com/plastics-and-packaging-in-the-aerospace-industry/> Spotlight: Boeing 787 Dreamliner – 'Green' plastic airliner takes off Financial Times – <https://www.ft.com/content/d22403b4-27e7-11dc-80da-000b5df10621>

5.1.2 Plastic wastes

Plastics have increased the standard of living, creating widespread prosperity across various domains. The order created by plastics in various sectors is disrupted by the chaos created after plastic utilization, due to the resulting plastic waste. Plastics in packaging products, for example, are mostly disposed of after its short-term utilization. Out of the total plastic waste ever produced, only 600 million metric tons (Mt) (9%) were recycled, and 800 Mt (12%) was incinerated. Mismanaged plastic waste (either littered or inadequately disposed) constituting around 6300 Mt (79%) is accumulated in landfills or the natural environment (Geyer *et al.*, 2017).

In 2025, China is predicted to contribute to 26% of the global plastic waste generation, and East Asia and the Pacific will maintain its contribution of around 60% of the total plastic waste generated (Jambeck *et al.*, 2015). Each year at least 8–12 Mt of plastic waste leaks into the ocean. Harmful additives are often added to improve various properties of plastic products. The classification of additives is shown in Figure 5.2. Despite the usefulness of the additives in enhancing plastic properties and prolonging their life, its potential to contaminate soil, air, water and food is widely documented in literature. Often, after a long period of usage, the plastic products leach or leak harmful additives which pollute the biotic and abiotic environment.

Quote: *Without a well-designed and tailor-made management strategy for end-of-life plastics, humans are conducting a singular uncontrolled experiment on a global scale, in which billions of metric tons of material will accumulate across all major terrestrial and aquatic ecosystems on the planet. (Geyer et al., 2017, page 3)*

In 2019, an estimated 130 Mt of single-use plastics (SUPs) was discarded (Charles *et al.*, 2021) as shown in Table 5.1. In 2019, just 20 polymer producers accounted for more than half of all SUP waste generated globally. There has been collective industry failure to both forecast the problem of SUPP and

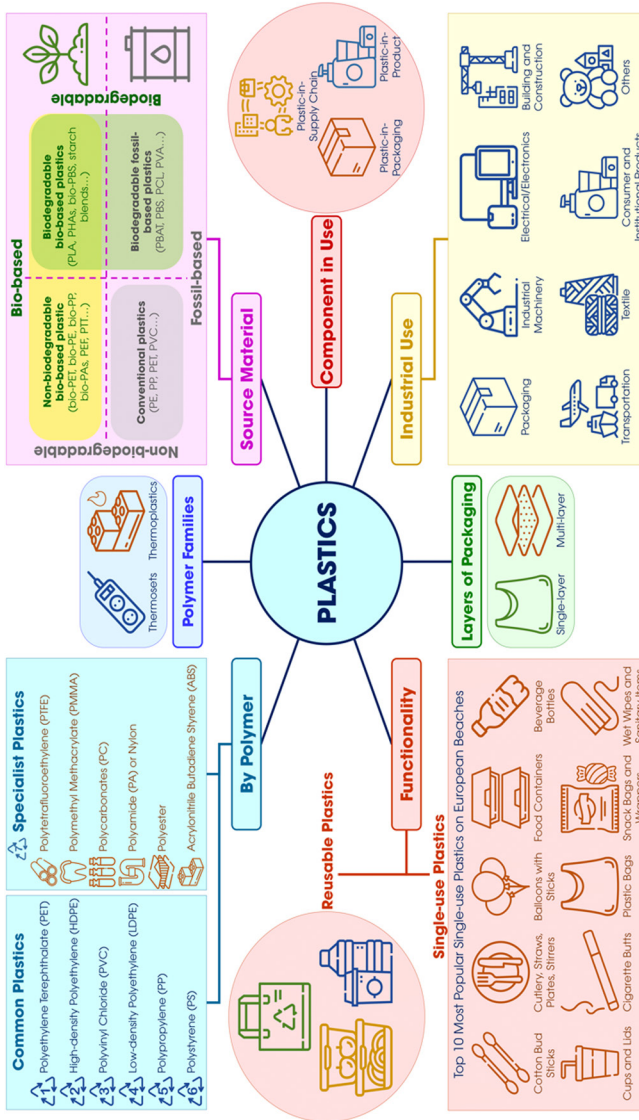

Figure 5.1 Categorization of plastics.

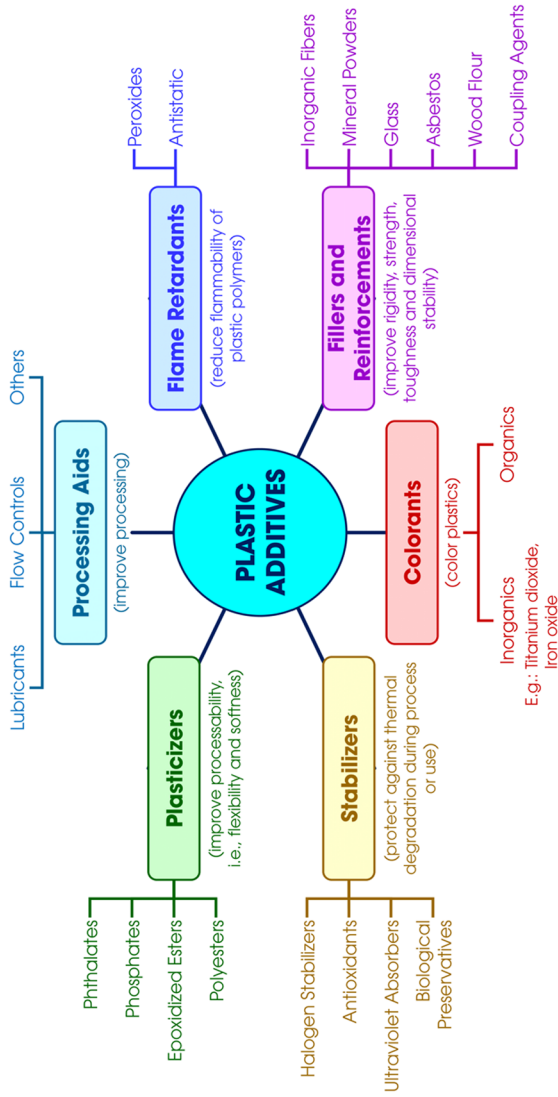

Figure 5.2 Classification of plastic additives.

Table 5.1 SUPP Categories Thrown Away (million metric tons) in 2019.

SUPP Category	Discarded
Food bottles	25
Retail bags	16
Food packaging	15
Sheet packaging	10
Film packaging	18
Trash bags	15
Non-food bottles	5
Industrial bags	3
Laminated packaging	3
Caps and closures	2
Cups and containers	1
Pharmaceuticals, cosmetics, and toiletries	1
Other polymers	16
TOTAL	130

Source: Charles et al. (2021).

transition away from fossil-fuel-based feedstocks. In addition, there is a planned expansion of virgin polymer production capacity which threatens the hopes of a circular plastics economy. According to the Minderoo Foundation's Plastic Waste Makers Index (2021), high-income countries typically supply significant volumes of polymer to low and lower-income countries. This results in high volumes of mismanaged wastes causing plastic pollution due to poor waste management systems.

5.1.3 Plastic pollution and climate change interactions

The production and management of plastics and plastic waste influence climate change, and climate change drives plastic waste movements. Nearly every piece of plastic begins as fossil fuel, and greenhouse gases (GHGs) are emitted at each stage of the plastics life cycle. The stages include fossil fuel extraction and transport, oil refining and plastic manufacturing, managing plastic waste, and plastic's ongoing impact once it reaches marine ecosystems (oceans, freshwater, etc.) and terrestrial ecosystems. Nearly two thirds of GHG emissions is produced at the early stages, from fossil fuel extraction to the production of resins. A large amount of energy is required to refine the fossil fuel, crack the distilled constituents into monomers and synthesize the base starting materials.

- Extraction and transportation of fossil fuels are energy intensive. Around 12.5–13.5 Mt of carbon dioxide equivalent (CO₂e) are emitted annually during the extraction and transportation of natural gas to create plastic feedstocks in the United States (CIEL, 2019).
- In the process of cracking, cracker plants take ethane, a liquid natural gas by-product, and 'crack' the molecules to produce ethylene, a root

chemical used to manufacture a variety of plastic products. In 2015, emissions from manufacturing ethylene (a building block for polyethylene plastics) were reported at 184.3–213 Mt of CO₂e, which is equivalent to annual emissions from about 45 million passenger vehicles, according to the CIEL report.

In addition, the climate variables such as precipitation patterns and rising sea levels influence the movement of plastic wastes and result in GHG emissions upon degradation of plastic products in open environments as shown in [Table 5.2](#).

5.1.4 Plastic waste management options

The current common types of plastic waste management options include waste incineration and waste-to-energy recovery, plastic recycling (from primary to quaternary methods), landfilling, and dumping of plastic wastes. A CIEL report (2019) computed the GHG emissions from recycling, landfilling and incineration with energy recovery, based on the data available for plastic packaging waste.

- (a) **Waste incineration and waste to energy incineration** are often thought of as promising solutions to large-scale, land-based plastic pollution. The volume reduction coupled with energy recovery appears to offer a lucrative solution. As per the analysis, net GHG emissions attributable to the incineration of plastic packaging are estimated to be 16 Mt of CO₂e in 2015. Burning 1 Mt of plastics results in an emission of 0.9 Mt CO₂e, even when 2 Mt of CO₂e can be offset by energy recovery.
- (b) **Landfilling and dumping of plastics:** Of the total plastics produced, 75% are dumped in landfills/dumpsites. Landfill wastes of fossil fuel origin do not emit GHGs, nor are they counted as a carbon sink. Landfills produce acids by decomposing organics and leaching heavy metals and plastic additives to nearby water bodies. Especially in developing

Table 5.2 Influence of climate variables on plastic waste.

Climate Variables	Impact on Plastic Waste
Atmospheric and sea-surface temperatures, ocean pH and rainfall patterns	Transportation and the rate of degradation of plastic debris in the ocean Contamination from leaching of plastic additives
Precipitation patterns	Rate and time period for transportation of plastic pollution into the sea
Wind speed and direction, ocean currents	Transportation and the depth of concentration of plastic debris in the ocean
Storms and rising sea levels	Releasing litter buried in beaches and dune systems Overwhelming of waste disposal sites and landfills Plastic debris deposited into the marine ecosystem through runoff

Source: CIEL (2019).

countries, long-term degradation of plastic additives and microplastics can cause long-term effects even though GHG emissions are lesser than incineration. Approximately, landfilling generates about 60 kg CO₂e / Mt of plastic packaging.

- (c) **Recycling** – This process denotes recovering the value of the material without altering the molecular structure of the polymer. Recycling is the best option in terms of reduction of GHG emissions. Making new products from recycled plastic packaging material is more than 3 times efficient in terms of GHG emissions than manufacturing those same products utilizing virgin raw materials. Recycling 1 Mt of plastic packaging results in the conservation of 1.4 Mt CO₂e.

Box 5.2 Plastic pandemic

Plastics during the COVID-19 pandemic quote:

‘Plastics have been the **material of choice** in the medical field for decades and we live healthier, longer, and better because of these materials. The global plastics industry stands ready to assist authorities and public health advocates in making sure our materials and products are on the frontline of **combating the spread of coronavirus**.’

- Tony Radoszewski, President and CEO of the Plastic Industry Association based in the US (<https://www.plasticstoday.com/medical/industry-association-ceo-testifies-congress-plastics-life-saving-role-during-pandemic>).

‘Stores that were previously reinforcing the use of reusable bags or cups are now potentially **breaking the positive habitual behaviors** developed around sustainability.’

Kate White, Professor of Marketing at the University of British Columbia, and Chair of UBC’s Ethics and Sustainability Group (<https://covid19.research.ubc.ca/people/kate-white>).

5.2 CIRCULAR ECONOMY: A TOOL FOR PLASTIC WASTE MANAGEMENT

With the current concepts of circular economy (CE) evolving constantly, there are no standard or commonly accepted definition which systematically considers all the common concepts within CE. Often, waste management aspects are always on the forefront of CE and are misconstrued as CE itself. However, CE encompasses more than waste management. The important elements of CE along with an emphasis on design and waste management aspects are discussed in subsequent sections.

Often, the concept of sustainable development has been regarded highly vague to be implemented leading to a loss in momentum. The scholars and

practitioners in the field of sustainability and business operation moved towards conceptualizing and implementing CE principles at different scales. CE is an industrial system that is restorative or regenerative by intention and design. It replaces the ‘end of life’ concept with restoration, shifting towards the use of renewable energy, eliminating the use of toxic chemicals, which imparts reuse. It aims for the elimination of waste through the superior design of materials, products, systems and innovative business models (Kirchherr *et al.*, 2017). A vibrant resource-efficient system can be achieved by CE in the following three steps:

- Narrowing the material loop by using fewer resources for making products,
- Retaining resources in productive use for a long time, and reusing them through recycling, and
- Cutting waste and reducing dependency on uncertain supplies that impedes sustainability.

CE aims to keep the value of the material at its highest level, based on the waste management hierarchy. The transitional path from a linear economy to a CE through 9R is shown in Figure 5.3.

Material flow analysis (MFA) and life cycle assessment (LCA) are two powerful tools to understand the performance of the products and systems and improvise the transition to a circular system. Suitable indicators are required

9 R for Transition from Linear to Circular Economy

Circular Economy	Strategies	
Increasing Circularity	R0 Refuse	Make product redundant by abandoning its function or by offering the same function with a radically different product
	R1 Rethink	Make product use more intensive (e.g. by sharing product)
	R2 Reduce	Increase efficiency in product manufacture or use by consuming fewer natural resources and materials
	R3 Reuse	Reuse by another consumer of discarded product which is still in good condition and fulfils its original function
	R4 Repair	Repair and maintenance of defective product so it can be used with its original function
	R5 Refurbish	Restore an old product and bring it up to date
	R6 Remanufacture	Use parts of discarded product in a new product with the same function
	R7 Repurpose	Use discarded product or its parts in a new product with a different function
	R8 Recycle	Process materials to obtain the same (high grade) or lower (low grade) quality
Linear Economy	R9 Recover	Incineration of material with energy recovery

The 9R Framework.
Source: Adapted from Potting *et al.* (2017, p.5)

Figure 5.3 Transition from linear to CE.

to focus on sustainability issues in addition to considering the technical reality. The developed circularity indicators are particularly intended for use in product design but can also be used in internal reporting or for procurement and investment decisions. These indicators have been developed at the product and company levels. The CE indicators focus on overall lifecycle of the product starting from product design, followed by product manufacturing, servicing and product remanufacturing taking the materials from non-renewable sources to understand circularity strategies needed and associated business benefits.

Definitional Difference 1. What is the difference between MFA and LCA for CE?

MFA is the study of physical flows of natural resources and materials into, through and out of a given system (usually the economy). It helps in the realization of CE goals by estimating the current material flows, and aids in the implementation of suitable systems for realizing CE goals.

LCA is an environmental assessment methodology based on potential flows of pollutants entering different compartments of the environment (e.g., air, water, soil) and the assessment of associated environmental impacts.

5.2.1 Elements of CE

The CE consists of various elements that are essentially important for the transition from a linear to a circular system. The elements of the CE wheel are shown in [Figure 5.4](#). The elements include (a) design for sustainability, (b) cleaner production, (c) reverse logistics, (d) industrial ecology, (e) energy efficiency, (f) waste management, (g) product life extension and (h) product as service.

5.2.2 Design for sustainability

Design for sustainability (D4S) is an interesting approach used to design a product with a special consideration for the environmental and social aspects during the entire life cycle. D4S should take into consideration the various stages of the product, from the design to the final treatment and disposal of the product. D4S considers critical elements of design including the raw materials, energy used for production, consumption and disposal with the intention of designing the product for recycling, optimization and reuse. Three main processes of D4S involve benchmarking, choice editing and design for recycling (D4R).

5.2.2.1 Benchmarking for D4S

Benchmarking is the process of improving the performance of an existing product by continuously identifying, understanding, adapting and improving the outstanding practices and processes found both within and outside



Figure 5.4 Elements of CE.

of the organization. It also gives a structured approach for comparing the environmental performance of the products against the competitors' products and generating improvement possibilities (Crul, 2009).

Definitional Difference 2. Resource Efficiency and Eco-Efficiency

- (a) Resource efficiency denotes efficient use of raw materials or products used to fully obtain the functionality of a plastic product. Plastic processors are using even smaller quantities of plastic to manufacture many products. In the 1970s, the average yoghurt pot weighed 10 g; today it weighs only 5 g.
- (b) Eco-efficiency denotes enhancement of aspects of environment and system performance along with the reduction in material consumption for manufacturing plastic products. For example, Microplast produced 300 000 1.8 L HDPE bottles/month for milk and juices redesigned with a Parison control system and reducing the wall thickness from 0.6 mm to 0.3 mm. This led to a reduction in HDPE consumption to 9000 kg HDPE/month (resource efficiency aspect) along with environmental impact reduction by 43% and better distribution efficiency by 25%.

The Old HDPE bottle is redesigned in a blow-moulding machinery equipped with Parison control system resulting in material reduction (thickness of the bottle).

5.2.2.2 Steps in benchmarking

Step 1 Setting objectives: In this step, the criteria which have to be optimized for the product are considered. The objectives are set in a way that optimizes and improves the design, to resolve existing problems after they are identified. At times, various aspects of products are often compared and benchmarked to improve the overall product design and performance.

Box 5.3 Sony's flame-retardant recycled plastic ion LCD TV screen rims

In 2011, Sony Corporation developed a special type of recycled plastic made up of more than 99% recycled material with flame-retardant properties. The plastic named 'SoRPlast (Sony Recycled Plastic)' is mainly a blend of waste optical sheets and waste optical discs generated during the production process by The Sony Group manufacturing facilities or other sources. Recycled plastic is used in the bezel (screen rim) of three liquid crystal display (LCD) television models, and the company plans to reduce CO₂ emissions during the plastic manufacturing process by approximately 80%, compared with conventional products. These efforts are to realize their long-term environmental plan called 'Road to Zero', which sets a vision to achieve zero environmental footprints of all Sony products and services by 2050.

Source: https://www.japanfs.org/en/news/archives/news_id031559.html

Step 2 Sample selection: In this step, along with the chosen product, similar products from the chosen field are taken for comparison.

Step 3 Functional unit identification: In this step, the components which are related to the specific problem addressed are identified. Systems thinking gives a clear picture of the connection of this functional unit to other parts of the product.

Step 4 Finalizing focal areas: To optimize the problem at hand, the main focus of the D4S Benchmark can be divided into important focus areas. For example, if environmental performance improvement is chosen as the objective of the study, the focal areas considered can be weight, hazardous substances, energy consumption, and the recycling and disposal of packaging.

Step 5 Parameters to measure: In this step, the qualitative aspects of the focal areas are to be converted to quantitative variables. Energy is expressed in terms of kWh, and materials in terms of g. In most cases, there may be more than one variable to describe one focal area. For example, for the benchmarking of Philips Computer Monitor, the weight of iron, aluminium, flame retardants, length of cable and disassembly time were noted.

Step 6 Planning disassembly session: In this step, a physical disassembly session is to be organized. All the products chosen for the study are disassembled and various parameters which are to be measured are calculated using instruments like weighing balance, stopwatch, multimeter, camera and other measurement devices.

Step 7 Processing and comparing to benchmark: After the individual disassembly of components, the processing of information and comparison of the products can be carried out. With the focal areas chosen for the objectives, this stage can give information regarding where each product stands in terms of each criterion or parameter, and which areas need to be improved.

Step 8 Reviewing results and improvement options: A careful analysis of the results is important in understanding the improvements which are to be made. The solutions for the improvements can be taken from the competitor's product and applied to the current product. It is also better to look for innovative alternatives, unconsidered in any other design of similar products.

Step 9 Prioritizing the improvement options: Apart from environmental considerations, various considerations such as societal and consumer benefits can be considered. Each of the improvements which can be implemented in the focal areas can be ranked, validated, prioritized, and integrated into the design.

Step 10 Implementing improvement options: Depending upon the practicality of the improvement options, various techniques can be tested and implemented. D4S is the process of continuous optimization where the products' performance can be continuously improved upon the innovation of new techniques, materials and process modifications.

Box 5.4 Design for environment at Dell

Dell's design principles include:

- (1) Easy disassembly: all parts are easily separable with commonly found tools.
- (2) Minimal glues and adhesives: glues and adhesives can create processing challenges for recyclers, so Dell has come up with other methods such as the innovative snap fit method to accomplish design goals.
- (3) Restrictions on paints and coatings: Dell prefers integral finishes instead of exterior coatings which can interfere with the recycling process or degrade certain plastics during processing. If painting is required, Dell uses paint that is compatible with recycling.

- (4) Single-access service door: easy access for repair and recycling.

Designing plastics circulation

<https://www.slideshare.net/AnneRaudaskoski/designing-plastics-circulation>

5.2.2.3 Choice editing

Choice editing involves the use of specified factors and set standards to filter unsuitable options in the range of products and services available to consumers. The process of choice editing starts with identifying core environmental issues associated with using an unsustainable product or component added to the plastic product.

Choice editing is an important mechanism for removing environmentally detrimental products from the market, and in achieving overall environmental improvements. Consumer choice and behaviour are a function of the options available to them, or in other words, a response to government policy, choices of manufacturers and service providers, and retailers' decisions on what products to (or not to) stock on their shelves.

All the key stakeholders, that is, Governments, NGOs, and consumers have a key role in moving towards a sustainable society. However, in developing economies, it is often up to the manufacturers and service providers to come up with more sustainable products than unsustainable ones. Due to the competitive markets and to increase the profitability of the products, manufacturers often tend to make unsustainable choices which come with a high environmental cost.

Box 5.5 Are we using the right bottle?

We all know the importance of staying hydrated. The method of choice for most people these days is to carry around a trendy, colourful plastic sports bottle filled with water. This is usually the tough, hard, plastic bottles that everyone from bikers and hikers to active business folks to on-the-go moms tote around – not to mention students ranging from elementary to college. A lot of these tough plastic bottles are made of polycarbonate plastics. These products are made up of a special type of plastics (7th type of Plastics or Other types). The main problem with these products is that it is not easily recycled by material-to-material recycling facilities.

In 1998, Hunt discovered that plastics made from polycarbonate resin can leach bisphenol-A (BPA), a potent hormone disruptor. Another study was conducted in a non-randomized intervention amongst 77 Harvard College students to compare urine BPA concentrations after a washout phase of 1 week to those samples taken after an intervention week during which most cold beverages were consumed from polycarbonate drinking

bottles. One week of polycarbonate bottle use increased urinary BPA concentrations by two thirds. Regular consumption of cold beverages from polycarbonate bottles is associated with a substantial increase in urinary BPA concentrations, irrespective of exposure to BPA from other sources. The bulk of the research found that no to minimal leaching was produced, far below strict safety standards. In the case of baby bottles, the FDA amended its regulations in July 2012, to not permit the use of BPA-based polycarbonate resins in baby bottles and sippy cups.

Conclusion: To avoid exposure to BPA, unlined stainless steel, copolyester lined aluminium or copolyester plastic drinking bottles should be used.

Source: <https://www.onyalife.com/bpa-free-water-bottles/>
<https://www.ncbi.nlm.nih.gov/pmc/articles/PMC3210908/pdf/nihms311473.pdf>

5.2.2.4 Design for recycling

Design for recycling (D4R) aims to facilitate the recovery of plastic products for additional use. It provides an understanding of how different components of plastic products must be manufactured to be compatible with recycling. It involves the product with design elements such as caps, labels, additives and their behaviour in a given recycling system. The simple elements for plastic design involve easy separation, easy removal of the label, monolayer design and usage of compatible materials amongst other aspects. Additionally, other performance criteria such as product safety, shelf life or sustainable resource use should also be considered. D4R targets the same features as design for disassembly (D4D). At the packaging level, it is a question of designing the packaging so that it is:

- Collectable and clearly identifiable,
- Detectable when ending up in the sorting fraction for recycling, and
- Recyclable so that secondary materials can be produced according to market requirements.

Box 5.6 Mirra chair design for recycling

The Mirra chair by Herman Miller is one of the finest green products on the market. It is the first chair produced under Herman Miller's outstanding Design for the Environment (DfE) internal directive utilizing the Cradle-to-Cradle Design Protocol. Herman Miller evaluates new product designs in three key areas.

- (1) Material chemistry and safety of inputs: What chemicals are in the materials we specify, and are they the safest options available?

- (2) Disassembly: Can we take products apart at the end of their useful life, to recycle the materials?
- (3) Recyclability: Do the materials contain recycled content, and more importantly, can the materials be recycled at the end of the product's useful life?

Source: https://www.c2ccertified.org/assets/uploads/Herman_Miller_Journal_Of_Industrial_Ecology.pdf

Box 5.7 Edible food packaging

Edible food packaging is a type of packaging that is designed to be eaten or can biodegrade efficiently like the food that it contains. This type of packaging comes in many forms and is constantly being improved and innovated to be made from many different types of substances.

A Brazilian fast-food chain has introduced a clever solution for customers tired of having to unwrap their hamburger before eating it. As part of a marketing campaign designed to position their burgers as literally irresistible and reduce paper waste headed for the landfill, a restaurant chain called 'Bob's' recently experimented with a burger wrapping made from edible paper. The campaign was so successful that not a single customer threw away the wrappings, which meant a lot less trash to haul out to the dumpster. A brand-new plastic sachet and packaging made from seaweed, edible bioplastic, is applicable for sugar sachets, coffee sachets, seasoning sachets, burger wraps, rice wraps, and is not limited to semi-solid and liquid packaging like shampoo and lotion sachets. It has 2-year shelf life without using preservatives, is biodegradable, dissolves in warm water and is 100% nutritious.

OOHO Edible Water Packaging

This unusual technology is based on seaweed. The principle involves dipping a ball of ice in a mixture of calcium chloride (a common food additive), and brown algae extract. As the ice melts, the membrane stays intact, creating a gelatinous, contained ball of water.

Source: <https://www.stylus.com/wxxfcr>
<https://www.packagingdigest.com/sustainability/incredible-ooho-water-bottle-edible>

5.2.3 Extended producer responsibility

Reverse logistics is a critical aspect of CE. It is a type of supply chain management that moves goods from customers back to the sellers or manufacturers of the goods. Particularly, due to the current sustainability concerns and rising trends

of green consumerism among customers, companies are boosting their capacities to bring the products that they are selling back into their supply chain. Extended producer responsibility (EPR) is an environmental policy approach under which the responsibility of producers for their products is extended to include the social costs of waste management, including the environmental impact of waste disposal. EPR involves the collection of particular end-of-life products, product categories or waste streams. In some cases, such waste is traditionally handled appropriately through municipal waste management programs. It provides incentives to prevent waste at the source, promote product design for the environment, and support the achievement of public recycling and material management goals. At times, the plastic producers offset their responsibility to a private organization named Producer Responsibility Organization (PRO) who collect and handle their waste. PRO-based EPR schemes for packaging apply variable fees based on the types of plastic packaging material placed on the market. Fees for plastic and composite packaging materials tend to be significantly higher than fees for other packaging materials. Figure 5.5 shows the differences between traditional and EPR-driven supply chains, and the importance of reverse logistics as an essential element of CE is shown in Figure 5.6.

5.2.4 Smart plastic waste management systems: role of artificial intelligence

Technology and innovation are some of the biggest motivators for circularity in plastic waste management. Smart waste management systems are not a distant

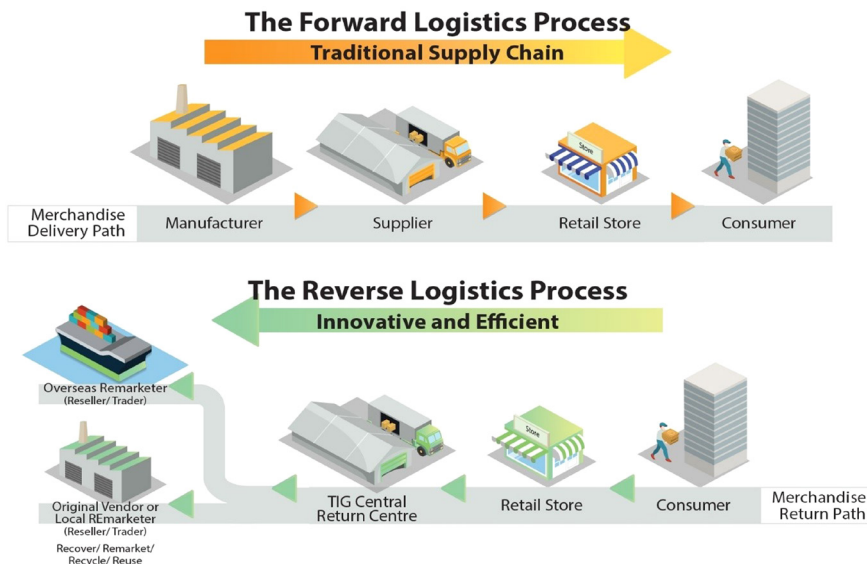

Figure 5.5 Traditional vs EPR-driven supply chains.



Figure 5.6 Reverse logistics and EPR in CE.

dream for developing countries like China and India. However, the countries are moving towards low-tech, and laborious solutions. Many governments are planning to invest in new technologies which could potentially increase the effectiveness of plastic waste management and promote sustainability. *The tools of artificial intelligence (AI) such as machine learning (ML), robotics and neural networks can substantially fill the gaps of plastic waste management systems along the plastic supply chain and help in minimizing the uncertainties of current practices. For instance, blockchain technology serves as a trust-based platform between plastic waste segregators, recyclers and recycled feedstock buyers (manufacturers). The automated sorting systems with near infrared (NIR) sensors and three-dimensional cameras can identify the individual materials and segregate plastic wastes from the mixed solid waste stream. Collaborative robots (Cobots) can work alongside humans in plastic sorting, and smart bins in cities can reduce GHG emissions and help in communicating information on bin fill levels and ensure collection only when the bin is full. In addition to segregation at source, robots can help in the collection and transportation of plastic wastes with improved logistics. AI can also improve the process of ensuring the quality control (QC) of plastics produced by plastic mould surface analysis, when compared with traditional QC procedures. *Smart systems can aid in understanding the fate of plastics discarded into the ocean, monitoring the



Figure 5.7 Smart plastic waste management systems and energy efficiency in CE.

marine litter, and devising remediation strategies in marine plastics abatement. For example, there are various aspects of automation and energy efficient measures considered while designing the smart waste collection systems. SmartBin Volume Control and Collection is one of the classic examples of this CE element. The modern bins can be equipped with a piston that is useful for the compression of garbage. Once the threshold level is reached, the bins lock to prevent additional waste entry thereby avoiding overflow and notify the server to initiate cleaning process. A RFID tag is placed in the bin, and a RFID reader is placed with the antenna in the truck. The model establishes a stronger waste collection system which reduces the overflowing trash cans by a factor of 4 and helps improve energy efficiency. As the regular trash pickup is enabled by the technology of these trash cans, the frequency of collection improves (Gupta *et al.*, 2019). The criticality of smart systems for transition to CE is shown in Figure 5.7.

5.2.4.1 Resource efficiency for plastic economy

Resource Efficiency can be explained in simple terms as creating more while using less. This concept of handling materials sustainably considers the Earth's limited resources while minimizing environmental impacts. It allows for more to be created with less, and to deliver greater value with lesser input. With increased consumption levels during the industrial period, large volumes of

resources were extracted which led to unsustainable growth causing major environmental impacts. Global resource extraction grew from 38 billion tons (Bt) in 1980 to around 68 Bt in 2008, representing an aggregated growth of 78%. Plastic production has surged over the past 50 years. Plastic production increased from 12 Mt in 1964 to 311 Mt in 2014 and is further expected to reach 1124 Mt in 2050. This can be attributed to increased plastic consumption over the years, due to the versatility of plastics (WEF, 2016).

Plastics are often termed as ‘Skin of Commerce’ due to its rapid normalization in the food sector. Due to the advent of plastics as the main packaging material, there has been a major replacement of glass and metal containers and packaging. In the US, plastic contribution in the waste stream increased from 0.12 Mt in 1960 to 13.98 Mt in 2013 (Tsiamis *et al.*, 2018). The highest percentage in municipal solid wastes (MSW) is attributed to plastics. The overall quantity of MSW doubled between 1960 and 2013. However, the quantity of plastics in MSW increased by 83 times between the same period. Every other category of MSW (Paper, Glass, Metals, Food, Yard Wastes and other wastes) decreased by less than a factor of 3. Plastics played a role in decoupling MSW and down-gauging that reduces the amount of material needed. This is because plastics are more resource efficient than its alternatives and have contributed to a reduction in the weight of MSW.

5.2.4.2 Material loss in plastic life cycle

Plastics are often subjected to a high level of material loss than any other packaging material due to their low value, lack of complementary recycling infrastructure in developing countries and other related factors. In 2016, 95% of plastic packaging material value was lost to the economy after a short first use. As per global flows of plastic packaging materials in 2013, only 14% of plastic packaging was collected for recycling. It is estimated that at least 8 Mt of plastics leak into the ocean, equivalent to dumping contents of one garbage truck into the ocean every minute. Overall, it is found that 3.0 and 5.3 Mt of micro and macro-plastics, respectively, are lost to the environment (UNEP, 2018). The primary sources of macroplastics are mismanaged MSW (either littered or disposed of in unsanitary landfills/dumpsites), which account for half of the total macroplastics lost to the environment. In the aspect of microplastics, the prominent microplastics in the environment were PP, LDPE, HDPE, and PET. These findings corroborate the theory that most microplastics result from the weathering of macro-plastics.

Definitional Difference 3. What is the difference between Material Intensity and Decoupling?

- Material intensity refers to the effectiveness with which an economy uses materials extracted from natural resources to generate economic value-added (e.g., the amount of raw materials,

in kilograms, required to generate one unit of GDP, in dollars). Usually, the material intensity is measured as domestic material consumption (DMC) per unit of GDP that is, DMC/GDP .

- Decoupling is breaking the link between ‘environmental bads’ and ‘economic goods’. Decoupling at its simplest is reducing the number of resources such as water or fossil fuels used to produce economic growth and delinking economic development and environmental deterioration.

Definitional Difference 4. What are Absolute Decoupling and Relative Decoupling?

- Absolute decoupling occurs when environmental impacts are decreasing while the economy is expanding.
- Decoupling is said to be relative when an environmental variable is increasing, but at a lower rate than the economic variable.

5.2.5 CE and 3Rs in plastic waste management

5.2.5.1 Introduction to 3Rs in plastic waste management

The principle of reducing waste, reusing, and recycling resources and products is often called the ‘3Rs’. The first step in the 3Rs is ‘Reduce’ which denotes selecting things to reduce the amount of plastic waste generated. This is followed by ‘Reuse’ which is to extend the product lifetime and lastly ‘Recycle’ which is the pathway for the treatment of disposed plastic. Mostly, the concept of 3Rs relies tremendously on the third R, Recycle, which ranks lower in preference than Reduce and Reuse in the waste hierarchy. The prominence of recycling is a result of a majority of generated plastic waste being of a quality that does not reach the standards of reuse, or due to barriers such as lack of awareness and motivation to reuse plastic products. Recycling and reusing are critical in decoupling plastic use from the consumption of fossil-based feedstock. Currently, just 5% of the material value of plastic packaging is captured after single-use while USD 80–120 billion/year of material value is getting wasted in oceans and landfills. The aspect of waste management as a CE wheel component is depicted in [Figure 5.8](#).

3Rs and Job Creation – Typically, a plant producing approximately 50 000 Mt of recycled plastic will employ around 30 people. The job creation associated with landfilling and recycling is shown in [Figure 5.9](#). Collection, sorting, recycling, marketing and retail of recycled plastic products create higher employment opportunities than plastic waste sent to landfills or dumpsites. The plastic recycling industry in the US accounted for 9% of total recycling jobs (68 000), and generated USD 3.2 billion in wages and USD 500 million in tax revenue ([USEPA, 2016](#)).



Figure 5.8 Waste management in CE.

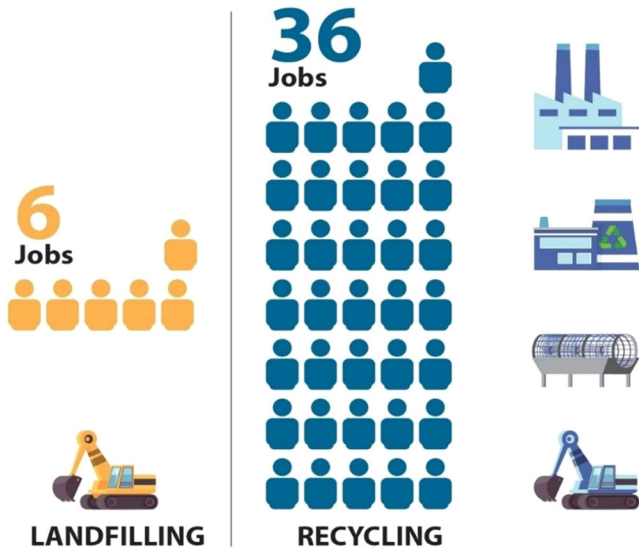

Figure 5.9 Job creation due to landfilling and recycling.

Definitional Difference 5. What is the difference between Upcycling and Downcycling?

- Upcycling – the quality of the recycled products or materials is higher than when first used
- Downcycling – the quality of the recycled products or materials is lower than when first used

5.2.5.2 3Rs – reduce – source reduction

Source reduction is the most preferable in the waste management hierarchy and goes a long way towards protecting the environment. The aspects of source reduction involve:

- Use of less raw material in production,
- Product use extension, and
- Use of safe alternative material and avoiding harmful materials.

A few types of plastic waste reduction strategies are the adoption of reusable plastics, using substitutes for plastics, voluntary agreements, public education, policy instruments like bans, levies, and incentives.

- **Public Pressure, Awareness towards Plastic Reduction and Voluntary Reduction Strategies**

Public pressure is one of the key aspects of policy decision-making. In Bali, the 'Bye Bye Plastic Bags' initiative is a social campaign led by two youths who mobilized people to petition saying no to plastic bags, collecting over 100 000 signatures. The governor then signed a memorandum of understanding (MoU) to phase out plastic bags in 2018 and a subsequent ban on single-use plastic bags in 2019. The 'Bye Bye Plastic Bags' has spoken to 50 000 students across 22+ countries in 9 different languages, becoming a well-known international movement of inspiration and youth empowerment (<http://www.byyebyeplasticbags.org/>). A longstanding change in cultural attitudes towards environmental matters is often not attainable through brief or standalone awareness campaigns. Public awareness strategies can include a wide range of activities designed to persuade and educate the masses.

- **Voluntary Reduction Strategies and Agreements**

Voluntary reduction strategies are taken up by manufacturers and retailers to reduce the consumption of plastic products based on choice. They do not attempt to force sudden changes in the market. They build on the understanding that for the change to be long-lasting, it needs to be a voluntary effort.

Box 5.8 Plastic Reduction Schemes in France

Ambitious Ban with Step-Wise Implementation

France recently launched its plan to eliminate all SUPs by 2040. The ambitious plan is part of a larger European Union-wide decision to ban many SUPs by 2021. In France, phase one began on January 1, 2020, with the government already banning the use of 3 common SUPs: plates, cups and cotton buds. In 2021, items including disposable cutlery, plastic takeout lids, confetti, drink stirrers, foam containers, plastic straws, and product packaging were forbidden. Vendors will legally have to allow customers to use their own containers, and there will even be penalties for those who use excessive plastic packaging.

Starting 2022, the French public no longer have the option to buy plastic tea bags, fast-food toys, and disposable dishes in restaurants. The government mandated water fountains to be installed in public buildings to avoid bottled water. Shops had six months to use up any stock of plastic products that they have. There was a temporary exemption up until July 2021 for compostable products containing at least 50% organic materials, and for cutlery used in health and corrections facilities, as well as usage on trains and aeroplanes.

French Prohibition of the ‘biodegradable’ claim or any equivalent claim on products and packaging

There is no scientific consensus on the definition of ‘biodegradable’. The ‘biodegradable’ claim does not encourage consumers to be careful, and not dispose of these products in the environment. It misleads them by suggesting that they will not affect natural environment, posing a setback to the fight against plastic pollution. The ‘biodegradable’ claim will be prohibited on products and packaging.

Ban on expanded polystyrene boxes in France

In the fast-food service sector, food is often served in expanded polystyrene (EPS) containers of the ‘kebab box’ type. These polystyrene containers are single-use and non-recyclable. The usage of these containers for on-site or on-the-go consumption has been prohibited since 1st January 2021.

Source: <https://easyecotips.com/france-has-pledge-to-recycle-100-of-plastic-by-2025/>

<https://surfrider.eu/en/learn/news/france-advances-the-fight-against-plastic-pollution-121505206147.html>

5.2.5.3 Plastic reuse

Reuse is ranked second in the waste management hierarchy. Conceptually, reusing plastics is an integral part of the circular mindset, offering a viable policy option to reduce material intensity. Globally, replacing just 20% of SUP packaging with reusable alternatives offers an opportunity worth at least

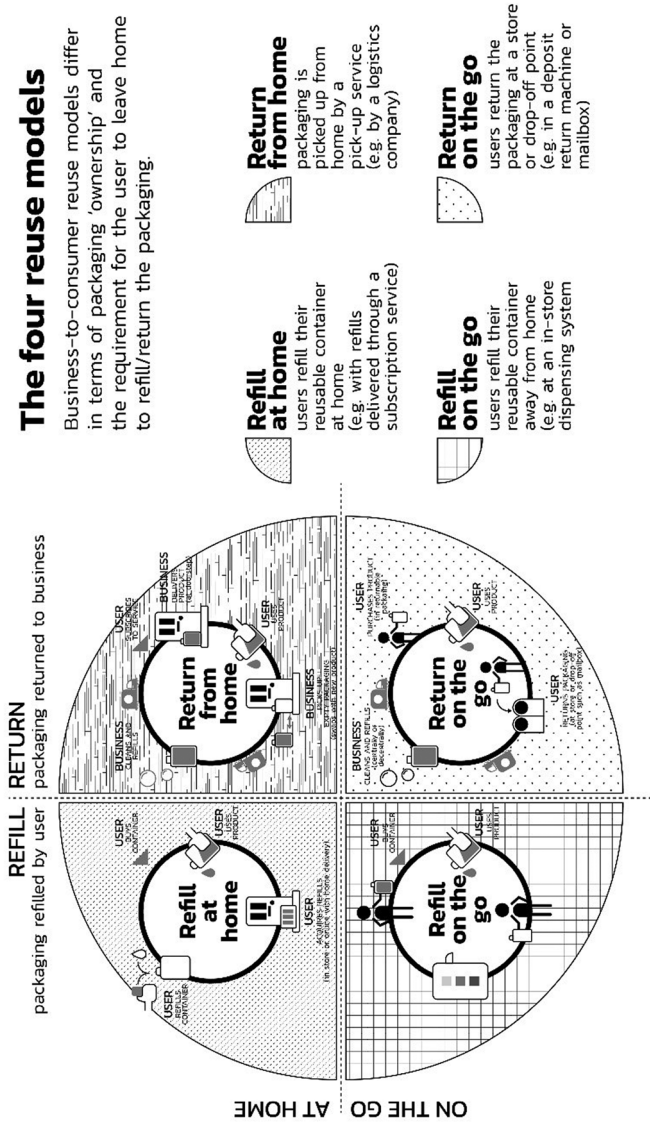

Figure 5.10 Plastic reuse models in plastic sector.

USD 10 billion. Various plastic reuse models are presented in [Figure 5.10](#). The Global Commitment has also seen over 100 business signatories, committing to switching to, where possible, from single-use to reusable packaging by 2025.

5.2.6 Product as a service

Product-as-a-Service (PaaS) also referred to as Product-Service-Systems, is a combination of products that are accompanied by services. It is often claimed a new business model, although it is not. Instead of paying a one-time fee, customers subscribe to a plastic product and pay a standard subscription fee and the product is then delivered as an experience or extra service. RePack is a company based in Finland which provides packaging-as-a-service for online retailers and web stores of known brands such as Filippa K, Ganni, and Mud Jeans. When customers order from the web store, they can opt for RePack's alternative reuse packaging. The order is then delivered to the customer in a RePack shipper with a prepaid return label. Subsequently, customers send the shipper back to RePack for a central quality check and redistribution.

Each shipper has a unique barcode that ensures individual shippers can be identified and linked to a specific shipment. This enables a reward for customers to be triggered when sending back the RePack container. Coupled with the advancement of technologies such as smart applications, and IoT, product service systems are innovative, highly dynamic and customer inclusive, and serve to reduce the plastic waste produced while adding enormous benefits to environment and economy. The importance of PaaS in CE is shown in [Figure 5.11](#).

5.3 POLICIES RELATED TO PLASTIC WASTE MANAGEMENT

5.3.1 Different instruments for influencing plastic consumption

To tackle the plastic problem effectively, cooperation from a wide range of groups (e.g., governments, producers, consumers, researchers and civil society) is required. Three common mechanisms can influence the consumption of plastics.

- Regulatory instruments
- Economic instruments
- Information Instruments

There is a clear upward trend in the number of public policy responses influencing the change in plastic consumption over the decade, at global, regional and national levels in the last few years. One of the major features of global plastics policy involves banning types of plastic bags over the past decade. Improved solid waste management systems are fundamental to solving the plastic pollution, particularly in lower and middle-income countries ([Karasik et al., 2020](#)). For effective policy instruments targeting plastic bag pollution, a mix of policy instruments, education and outreach to accompany regulatory or economic instruments is recommended. It is also important to emphasize the regulatory bans. Regulatory instruments are prohibitive actions that can either:

- Limit plastic: to prescribe a maximum amount, quantity or number of plastic material at any stage in the life cycle,

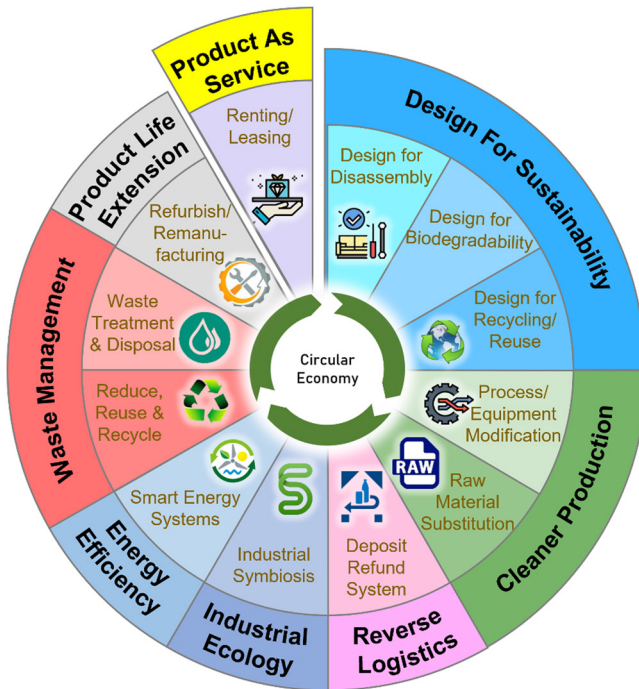

Figure 5.11 Product as a service in CE.

- Ban plastic: to fully or partially prohibit a specific type of plastic at any stage in the life cycle, or
- Prohibit irresponsible handling of plastic: to prohibit poor waste stewardship practices.

Box 5.9 Plastic Ban in Taiwan

Plastic Ban – Culture of Taiwan and Plastic Consumption Patterns

Taiwanese authorities encouraged the use of disposable cutlery as a preventative measure to stop the spread of hepatitis. According to the results of a recent survey released by the Global Views Monthly magazine, 70% of Taiwanese adults eat out frequently. The magazine additionally estimated that 3.3 million Taiwanese adults eat out every day. The trend is most common among those in the 20–29 age group, which includes students and young office workers. Citing tallies from the Directorate-General of Budget, Accounting and Statistics, the magazine noted that each Taiwan family spent some New Taiwanese Dollar (NT) \$50 000 (US\$1515) on average eating out.

The survey found that lunch is the meal consumed outside home most frequently, at 78.7%. This is followed by breakfast, with 66.8% of respondents indicating they usually eat this meal outside their home. As to the places where people eat out for lunch, 59.6% of respondents mentioned boxed lunch sellers, noodle eateries and snack bars. Eventually, the excessive use of plastics in Taiwan began to cause trouble for the environment.

Waking up from the Misfortune

In 2001, the Taiwan Environmental Protection Agency (EPA) enacted a ban on the distribution of free plastic shopping bags and foam boxes as 16 million plastic bags were produced in Taiwan every day. This caused problems in the disposal of plastic and foam solid waste. This measure came into force on June 5, 2002. The ban mandates no use of thin plastic bags with a thickness of not more than 0.06 mm (60 microns) and implementation of environmental tax measures at the retailer level, meaning stores are forbidden to give plastic bags and foam boxes free of charge

For the people of Taiwan to adjust their behaviour to get accustomed to carrying reusable bags, Taiwan EPA announced the revised targets, implementation and effective date of restricting the use of plastic shopping bags in August 2017. As a result, in 2018, another 80 000 stores had to stop handing out free plastic bags. In addition to the 20 000 stores in the original group, merchants who violated the law faced a fine of NT\$6000 (Taiwan EPA, 2018). A survey conducted by Taiwan EPA in July 2018, after a law banning retail stores from giving away plastic bags for free from January 1, 2019, found that 70% of consumers chose not to buy plastic bags. Taiwan has pledged that within the year 2030, it will ban all SUPP, including plastic bags, straws, plastic cutlery and glasses. These products are to be replaced by reusable or biodegradable items.

Source: <https://cleanthebeachbootcamp.com/taiwan-bans-single-use-plastic/>
<https://petrolworld.com/convenience-retail-news/item/28117-taiwan-free-plastic-bag-ban-across-1-00-000-stores-next-year-onwards>

Economic Instruments – In some cases, economic instruments are much better than regulatory instruments as they do not require intensive monitoring in terms of enforcement and control, providing more flexibility for households and firms to adapt to them. They are also more efficient from an economic point of view. Economic Instruments consist of the followings:

- (a) Subsidies (Incentives) – grants from the government to private entities, deemed to be advantageous to the public,
- (b) Cash for Buy-back (incentives) – for example, Deposit Refund Schemes – to give back used plastic in exchange for money,

- (c) Tax breaks (Incentive) – a lower tax rate to reward responsible plastic stewardship, and
- (d) Disincentive, Fee, Tax, Levy, or Duty – charge paid for irresponsible plastic stewardship.

Box 5.10 Ireland – PlastAX

Ireland was found to have the highest plastic waste generation at 54 kg/capita, substantially more than the EU average of 33 kg/capita. Each year, 169 000 tons of plastic packaging waste is generated in Ireland, which breaks down to 37 kg/capita, or the equivalent of 80 rugby balls or 215 iPhone 6 plus devices. The number of plastic bottles that end up in landfills every year would stretch around the island of Ireland 2000 times and could take up to 1000 years to biodegrade.

Ireland compared to other countries globally shows the highest effectiveness when it comes to reducing the use of plastic bags. The tax measure on plastic bags in effect in Ireland since 2002, requires consumers to pay for plastic bags. As a result of this policy, the use of plastic bags has reduced by 90%, and a significant reduction in the amount of solid waste has been observed. In 2002, the Irish Government introduced a EUR 0.15 environmental levy on plastic bags at points of sale to reduce their consumption and lower the adverse effects it has had on Ireland's landscape.

Publicly, discarded plastic bags amounted to 0.13% of plastic litter pollution in 2015 compared to an estimated 5% in 2001. The most recent survey data available for 2014 show that plastic bags constitute 0.13% of plastic litter pollution compared to an estimated 5% before the introduction of the levy. There is 40 times less litter from plastic bags in Ireland today compared to the figure recorded in the year 2000. In addition, it has been estimated that the number of plastic bags in marine litter decreased from 5% in 2001 to 0.25% in 2010 after the introduction of the levy.

Source: <https://ieep.eu/uploads/articles/attachments/0817a609-f2ed-4db0-8ae0-05f1d75fbaa4/IE%20Plastic%20Bag%20Levy%20final.pdf?v=63680923242>

<https://www.irishenvironment.com/iepedia/plastic-bag-levy/>

5.3.2 Unintended consequences, weak implementation and rebound effect

After China's 2008 policy on plastics, one of the largest plastic manufacturers in China 'Suiping Huaquiang Plastic', was shut down (Karasik *et al.*, 2020). The company went out of business and about 20 000 employees lost their jobs. A new product market such as an increase in sales of biodegradable packaging and paper bags may also occur when plastics are regulated by regulatory or

economic instruments. At times, the levy is ineffective as consumers are willing to pay for the use of environmentally harmful plastic bags. This is observed from the classic example of Botswana where the consumers are willing to pay more than double the price of the carrier bags in that period.

Rebound Effect – Over a long period, the reduction of plastic consumption is difficult to maintain. There are few studies (PlasTax of Ireland and Yogyakarta in Indonesia) that measure the policy effectiveness over a longer period where the levy is internalized by the consumers who tend to buy more plastic products in a long run.

5.3.3 Information instruments

Information instruments include research data collection or record keeping, education or outreach, and labels or placards to raise awareness and heighten understanding regarding plastic pollution amongst stakeholders. Information on the environmental impact of plastic products can

- Influence environmental motivations, and
- Increase consumers' willingness to pay for environmental protection.

It helps people acquire more knowledge, skills and values which serve to achieve a healthier environment and a higher quality of life. The process of putting forth a sound information instrument consists of the following steps.

- (1) Research, data collection, data reporting, or record keeping – for the analysis and management of plastic information
- (2) Educations or outreach: for informing people about the impacts of plastic pollution
- (3) Labels or placards: to share information of how consumers must dispose of the plastic product appropriately

Additionally, information instruments include plastic movements, documentaries and videos, awareness campaigns, websites, blogs, social media, billboards, and posters.

Eco-labelling – The label is the primary point of contact between the producer and the consumer, and should be an integral part of the producer's marketing plan. Eco-labeling is a voluntary method of environmental performance certification and labelling that is practiced around the world. When coupled with economic or regulatory instruments, information instruments can play a major role in influencing the public acceptance of change in plastic consumption behaviour.

5.4 SUSTAINABLE PUBLIC PROCUREMENT TO PROMOTE CE

Sustainable Public Procurement (SPP) is a potential tool to promote CE. Estimates suggest that SPP vary from 18–30% of GDP in the European Union (EU), and up to 50% in developing countries, making the procurement supply chain significant in the promotion of CE. There are various goals set out by the government agencies in their decision-making processes. This includes

- Promoting the recycling of plastic polymers as a substitute for virgin plastic,
- Identifying the main challenges and barriers for reducing plastic waste in mixed waste and residual waste streams, thus stimulating the prevention and recycling of plastic waste, and
- Diversion of plastic from the residual waste headed to incineration (creating a carbon-neutral energy source) and landfill.

Definitional Difference 6. Difference between Procurement and Purchasing

Procurement – The process of identifying, shortlisting, selecting and acquiring suitable goods or services from a third-party vendor through a direct purchase, competitive bidding or tendering process while ensuring timely delivery in the right quality and quantity.

Purchasing – Purchasing is the set of functions associated with acquiring the goods and services that an organization requires. Purchasing is a small subset of the broader procurement function. This process includes activities like ordering, expediting, receiving and fulfilling payment.

5.4.1 Dimensions of sustainable public procurement

Economic Dimensions of SPP – Over time, the higher benefit of the greener product is more than compensated by the much lower usage and disposal costs of the standard product. There are various levels of focus on economic dimensions of sustainability.

- Individual – reduction of fuel consumption, characteristics of individual members making purchasing choices
- Organizational – purchasing staff skills, development, awareness and training
- Supply Chain/network – innovation via design and management of the supply network
- Market/ Society – supporting disadvantaged sections by buying from small and medium enterprises

Environmental Dimensions of SPP – In addition to the Economic dimensions, the green procurement or Environmental component of SPP involves the purchase of environmentally friendly products and services. The comparison between the standard product and the green product is shown in [Figure 5.12](#). It includes the acquisition of products or services that have environmentally preferable characteristics such as

- Recycled content or easily recyclable products,
- Biobased or biodegradable products,
- Energy and water-efficient products,

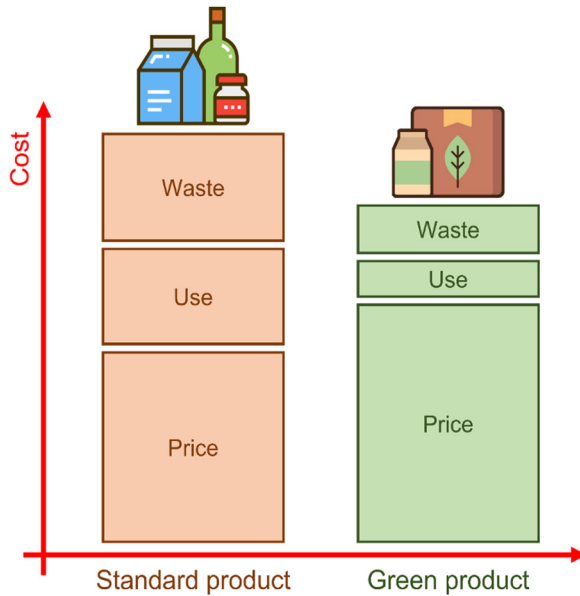

Figure 5.12 Costs and performances of standard product vs green product.

- Products using alternative fuels or renewable energy,
- Products with no hazardous or toxic chemicals, and
- Locally produced products.

Social Dimensions of SPP – The social dimension is an important part of SPP in an attempt to promote CE. SPP should be incorporated at multiple levels starting from the individual level to organizational level to the market level. It includes fair trade/eco-labels and CSR purchasing policies, policies against child labor throughout the supply chain, and involvement of Non-Governmental organizations (NGOs).

Violation of the social dimension of SPP may come in the forms of unethical trade, low wages, unsafe and poor work environment, poverty-level wages, wage discrimination based on gender, labor rights violation at the workplace. Hence, SPP should include the principles of ethical procurement through criteria such as transparency, good management, accountability and fair-trade practices to promote the CE along the plastics value chain.

Box 5.11 Sustainable Procurement at the Organization Level through Collaboration

New Sustainable Food Tray

Arcos Dorados, the largest independent McDonald's franchise in the world, operates restaurants in Latin America and Caribbean Islands.

Arcos Dorados has demonstrated its commitment to create a positive impact on the environment, announcing the substitution of the plastic trays used by clients in its outlets with a more sustainable option. The new trays rolled out as one of the sustainability measures represent the first step in the partnership between Arcos Dorados and UBQ Materials, an Israeli company that has patented a technology that converts household waste into a climate-positive, bio-based thermoplastic. In the first phase, 7200 serving trays made with UBQ™ were introduced in 30 McDonald's restaurants in 20 Brazilian state capitals, replacing the old plastic tray models. This initiative will gradually be extended to all McDonald's restaurants throughout the country, with 11 000 additional trays already in production.

McDonald's key global targets are a 36% reduction in GHG emissions from its restaurants and corporate offices by 2030 and a 31% reduction throughout its supply chain in the same period. Sustainable Food Trays are one of the steps taken towards it. Each ton of UBQ™ produced saves nearly 12 t of CO₂e. According to Quantis, a global leader of environmental impact assessments, this metric qualifies UBQ™ as the most climate-positive thermoplastic on the market.

Source: <https://www.businesswire.com/news/home/20210125005245/en/Arcos-Dorados-in-Brazil-Is-Serving-up-a-New-Sustainable-Food-Tray-in-its-McDonald%E2%80%99s-Restaurants>

5.4.2 Plastic disclosure projects

The objective of the Plastic Disclosure Project (PDP) is to help companies manage the opportunities and risks associated with plastic use (UNEP, 2014). It articulates the business case for companies to improve their measurement, disclosure and management of plastic use in their designs, operations and supply chains. To provide a sense of scale, the PDP sets out to quantify the physical impacts of plastic use translated into monetary terms.

It has six steps as follows:

- (1) Sector selection and mapping,
- (2) Plastic use quantification,
- (3) Scope and boundary selection,
- (4) Impact quantification,
- (5) Natural capital valuation, and
- (6) Application.

Step 1: Sector Selection – The sector for quantification of plastics is carried out. The focused sector is chosen out of food, soft drinks, tobacco, furniture, clothing and accessories, footwear, non-durable household goods, medical and pharmaceutical products, personal products, durable household products, consumer electronics, automobiles, athletic goods, toys, retail, and restaurant and bars.

Step 2: Plastic Use Quantification – The amount of plastic in the chosen sector or product was categorized into three types:

- Plastic-in-product which includes plastic used in products such as a child's plastic toy or a polyester T-shirt,
- Plastic-in-packaging which includes plastic used as packaging such as plastic bags and shampoo bottles, and
- Plastic-in-supply-chain which includes plastic used by suppliers such as bags containing fertilizer used by farmers.

Step 3: Scope and Boundary Selection – After modelling the plastic intensity of each sector, the next step is to calculate the associated environmental impacts. Impacts across the lifecycle of plastic including the extraction and processing of raw materials into plastic feedstock and the end-of-life fate of waste plastic are considered.

Step 4: Impact Quantification – Impacts include water abstractions, air, water and land pollutants from the extraction of collecting and treating plastic waste, and GHG emissions. They also include the end-of-life impact of chemical additives in plastic leaching into the environment, the economic cost of litter to the marine ecosystems, and the ecological costs associated with the loss of species.

Step 5: Natural Capital Valuation – Businesses depend on natural capital to be able to operate and provide goods and services to society. Natural capital comprises stocks of resources, such as water and clean air, and services such as climate regulation and food provision. There are many benefits from the natural capital valuation. For instance, using a common monetary unit enables companies to compare the significance of different impacts.

Step 6: Application – The valuations are applied at both the level of the consumer goods sector and the individual company.

Box 5.12 LUSH Cosmetics

LUSH is a cosmetics retailer headquartered in Poole, Dorset, United Kingdom. It produces and sells creams, soaps, shampoos, shower gels, lotions, moisturizers, scrubs, masks and other cosmetics. The company has taken many positive steps towards minimizing plastic use in all stages of its value chain famously designing its products to eliminate or minimize the need for packaging. It has redesigned many traditionally liquid products into solid form, resulting in about 70% (62% in 2010/11) of its product range requiring no packaging, hence the slogan 'We prefer naked'.

Lush redesigned its bottles, shaving 14% of the weight off the bottle in 2010 and where packaging is needed, lush favours using recycled material. Also, one such innovation is the solid bar shampoo that removes the need for a plastic bottle. The company sells 2.9 million units of shampoo bars, preventing the need for 5.7 million plastic bottles.

Source: <https://www.littlerocksoiree.com/post/132171/lush-cosmetics-opens-at-the-promenade-thursday-july-23>
<https://www.businessinsider.com/lush-factory-photo-tour-inside-the-willy-wonka-factory-of-soap-2016-9>

5.4.3 Barriers to circular economy

CE aids in enhancing resource efficiency. However, challenges to achieving circularity are present due to various factors.

- Lacking consumer interest and demand: A lack of consumer interest and awareness is a potential barrier to CE. Consumer demand can be a major driver towards CE, but there is currently little such demand.
- Cheaper non-renewable feedstock prices: The second category of prominent barriers that emerged is market barriers with low virgin material prices and high upfront investment costs for renewable feedstocks. Those raising low virgin material prices complain that these low prices will result in circular companies producing products more expensive than those products produced by traditional players.
- Perception of CE in companies: Discussions on CE are frequently restricted to the corporate social responsibility (CSR)/environmental

Barriers to Circular Economy

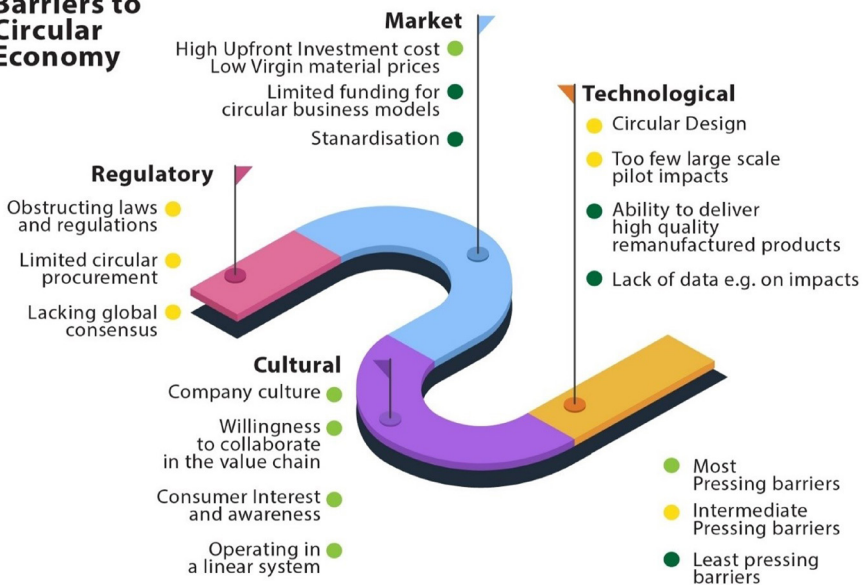

Figure 5.13 Barriers to CE.

departments of a firm, with more influential departments in a firm, for example, operations or finance, taking a limited interest in it. CE thus remains a niche discussion in many companies.

- Infrastructure and additional costs: Plastic waste management requires good quality infrastructure, appropriate technologies with safety precautions. Developing countries lack proper infrastructure facilities at this point. CE takes into account the additional societal and environmental costs even though it is beneficial in the long run.
- Regulatory measures restricting plastic movements: The most pressing regulatory barrier identified was obstructing laws and regulations. For example, it is possible to recycle bakelite, a waste in the Netherlands, which a company in Belgium was found to recycle. However, waste transport is not permitted between the two countries. The barriers to CE are shown in [Figure 5.13](#).

5.5 CONCLUSION

The speed of technological development is accelerating exponentially and by 2050, life will be unrecognizable compared to life today. Plastics will play a major role in technological development. Plastic consumption will increase with a consequent increase in plastic waste. Keeping sustainable development and climate change in mind, there is a higher need to make our plastic waste management systems smarter and dynamic. The CE principles aimed at reducing the production of plastic waste at multiple levels, and creating systems to reuse and recycle plastics will play a major role in reinstating sustainability goals in the plastics sector. The CE policies incentivizing businesses and creating social awareness will drive the plastics movement in the upcoming decades. The plastics industries will focus on designing sustainable plastic systems with energy-efficient plastic production, distribution and waste treatment aimed at reducing global plastic leakage. The COVID-19 pandemic has disrupted the current plastic consumption patterns. However, this trend is temporary as the innovation and smart plastic waste systems will focus on green recovery post-pandemic. In conclusion, the CE principles for plastic waste management are highly attainable if

- Governments legislate the right policies and regulate their implementation effectively along the plastics value chain at the global, national, and local level,
- Businesses and the private sector systemize and innovate the current plastic production and waste management systems, and
- Public interests align with proper consumption and waste management activities starting from responsible consumption to the management of plastic waste.

REFERENCES

- Andrady A. L. and Neal M. A. (2009). Applications and societal benefits of plastics. *Philosophical Transactions of the Royal Society B*, **364**, 1977–1984, <https://doi.org/10.1098/rstb.2008.0304>

- Center for International Environmental Law (CIEL) (2019). Plastic & Climate: The Hidden Costs of a Plastic Planet. <https://www.ciel.org/wp-content/uploads/2019/05/Plastic-and-Climate-FINAL-2019.pdf> (accessed 07 July 2021)
- Charles D., Kimman L. and Saran N. (2021). The Plastic Waste Makers Index. <https://cdn.minderoo.org/content/uploads/2021/05/27094234/20211105-Plastic-Waste-Makers-Index.pdf> (accessed 07 July 2021)
- Crul M. R. M. (2009). Introduction to the d4s: a step-by-step approach. In: Design for Sustainability – A Step-by-Step Approach, M. R. M. Crul and J. C. Diehl (eds.), UNEP, Paris, France, pp. 15–19.
- Environmental Protection Administration, R.O.C.(Taiwan). (2018). Plastic-Free Ocean Promoted in Response to International Trend. <https://www.epa.gov.tw/eng/F7AB26007B8FE8DF/fea08fd0-3afe-4ba9-a9c2-d5f6efd337d8> (Accessed 30 May 2022)
- Geyer R., Jambeck J. R. and Law K. L. (2017). Production, use, and fate of all plastics ever made. *Science Advance*, **3**(7), 1–5.
- Gupta P. K., Shree V., Hiremath L. and Rajendran S. (2019) The use of modern technology in smart waste management and recycling: artificial intelligence and machine learning. In: Recent Advances in Computational Intelligence. Studies in Computational Intelligence, R. Kumar and U. Wiil (eds.), Springer, Cham, Vol. **823**, pp. 173–188. https://doi.org/10.1007/978-3-030-12500-4_11
- Jambeck J. R., Geyer R., Wilcox C., Siegler T. R., Perryman M., Andrady A., Narayan R. and Law K. L. (2015). Plastic waste inputs from land into the ocean. *Science*, **347**(6223), 768–771. <https://doi.org/10.1126/science.1260352>
- Karasik R., Vegh T., Diana Z., Bering J., Caldas J., Pickle A., Rittschof D. and Virdin J. (2020). 20 Years of Government Responses to the Global Plastic Pollution Problem: The Plastics Policy Inventory. NI X 20-05. Duke University, Durham, NC.
- Kirchherr J., Reike D. and Hekkert M. (2017). Conceptualizing the circular economy: An analysis of 114 definitions. *Resources, Conservation and Recycling*, **127**, 221–232, <https://doi.org/10.1016/j.resconrec.2017.09.005>
- Tsiamis D., Torres M. and Castaldi M. (2018). Role of plastics in decoupling municipal solid waste and economic growth in the U.S. *Waste Management*, **77**, 147–155, <https://doi.org/10.1016/j.wasman.2018.05.003>
- UN Environment (2018). Mapping of global plastics value chain and plastics losses to the environment (with a particular focus on marine environment). In: M. Ryberg, A. Laurent and M. Hauschild. United Nations Environment Programme, Nairobi, Kenya, pp. 43–54.
- UNEP (2014). Valuing Plastics: The Business Case for Measuring, Managing and Disclosing Plastic Use in the Consumer Goods Industry. UN Environment Programme, Nairobi, Kenya.
- US EPA (2016). *Advancing Sustainable Materials Management: 2016 Recycling Economic Information (REI) Report*. National Recycling Coalition (NRC), Washington, DC.
- World Economic Forum (2016). The New Plastics Economy – Rethinking the Future of Plastics. Ellen MacArthur Foundation and McKinsey & Company, Isle of Wight, UK. <http://www.ellenmacarthurfoundation.org/publications>

MARINE PLASTICS ABATEMENT

Challenges, Implications, Assessments and Circularity

Marine Plastics Abatement Volume I provides comprehensive knowledge of plastic pollutions in marine ecosystems and their implications on human health, especially from the contamination of micro and nano-plastic particles by which the levels of plastic pollutions in marine, aquatic, terrestrial and atmospheric systems are described. In addition to emerging challenges by plastic pollution, this volume offers comprehensive assessment tools as well as practical models on “Circular Economy” with interesting real-world case studies and theoretical and numerical questions and solutions, recent scientific information, and practical exercises, to ensure a user-friendly text for readers.

Cover image: Another Life, photographed by Tom Potisit



iwapublishing.com

[@IWAPublishing](https://twitter.com/IWAPublishing)

ISBN: 9781789063196 (print)

ISBN: 9781789063202 (eBook)

ISBN: 9781789063219 (ePUB)

